

Department of the Army  
Pamphlet 750-8

Maintenance of Supplies and Equipment

# **The Army Maintenance Management System (TAMMS) Users Manual**

Headquarters  
Department of the Army  
Washington, DC  
22 August 2005

**UNCLASSIFIED**

# ***SUMMARY of CHANGE***

DA PAM 750-8

The Army Maintenance Management System (TAMMS) Users Manual

This administrative revision, dated 14 September 2011-

- o Corrects figure 2-5.

This administrative revision, dated 22 August 2005--

- o Revises the definition of "HORIZONTAL DASH" (para 3-10e(3)).
- o Corrects typographical and spelling errors and clarifies instructions.

This major revision, dated 25 February 2005--

- o Revises chapter 1.
- o Revises DA Form 2401 (Organization Control Record for Equipment) and DA Form 2402 (Exchange Tag) (chap 2); DD Form 314 (Preventive Maintenance Schedule and Record) (chap 3); DA Form 2405 and DA Form 2408-5 (Equipment Modification Record) (chap 5); and DA Form 5587 (Report of Drydocking, Painting, and Condition of Vessel Bottom) (chap 6).
- o Updates the majority of examples of completed forms used as figures (chaps 2, 3, 4, 5 and 10).
- o Adds guidance to administratively deadline equipment when past-due services exceed the 10 percent variance (chap 3).
- o Revises low-usage criteria (chap 3).
- o Synchronizes the application of a 10 percent variance in performance of scheduled services for both automated and manual procedures (chap 3).
- o Modifies the disposition instruction for DA Form 5990-E (Maintenance Request) (chap 3).
- o Provides updated major subordinate command addresses for field warranty claim actions (chap 3).
- o Revises instructions for FAA Form 6030-1 (Facility Maintenance to comply with Federal Aviation Agency Order 6000.15C (para 3-20)).
- o Moves Army Oil Analysis Program sampling intervals and instructions to Technical Bulletin 43-0211 (chap 4).
- o Updates instructions and figures for weapons record data in DA Form 2408-4 (Weapon Record Data) (chap 5).

- Rescinds U.S. Army Communications Security Equipment Modification Application Reporting System (RCSNSA 71028) to comply with National Security Agency guidance, U.S. Army Communications Security Logistics Activity, ATTN: USACSLA (B16), Fort Huachuca, AZ, and direction and policy outlined in AR 750-10.
- Updates information and figures on ammunition records and procedures and deletes requirements for the ammunition peculiar equipment report (chap 8).
- Updates procedures for reporting quality deficiency reports (chap 10).
- Synchronizes this pamphlet with AR 750-1.
- Rescinds DA Form 2409 (Equipment Maintenance Log (Consolidated)).



## Maintenance of Supplies and Equipment

# The Army Maintenance Management System (TAMMS) Users Manual

---

By Order of the Secretary of the Army:

PETER J. SCHOOMAKER  
*General, United States Army*  
*Chief of Staff*

Official:



SANDRA R. RILEY  
*Administrative Assistant to the*  
*Secretary of the Army*

**History.** This publication is an administrative revision.

**Summary.** This pamphlet covers the automated process, preparation, and management of forms, records, and data required to manage maintenance, control use, report deficiencies, document warranty actions, document equipment modifications; report equipment improvement recommendations; and report quality deficiency reports.

**Applicability.** This pamphlet applies to the Active Army, the Army National Guard of the United States, the U.S. Army Reserve, and contractors supporting operations in a contingency environment.

It applies to nontactical (commercial) wheeled vehicles and non-Army activities that have or support Army equipment and watercraft. It also applies to all air traffic control equipment, including tactical and U.S. Army-maintenance air traffic control and navigational aid facilities designated for use in the National Airspace System by the Federal Aviation Administration. During mobilization, procedures in this publication can be modified to support policy changes as necessary.

**Proponent and exception authority.** The proponent of this regulation is the Deputy Chief of Staff, G-4. The Deputy Chief of Staff, G-4 has the authority to approve exceptions or waivers to this regulation that are consistent with controlling law and regulations. The Deputy Chief of Staff, G-4 may delegate this approval authority, in writing, to a division chief within the proponent agency or a direct reporting unit or field operating agency of the proponent agency in the grade of colonel or the civilian equivalent. Activities may request a waiver to this regulation by providing justification that includes a full analysis of the expected benefits and must include formal review by the activity's senior legal officer. All waiver requests will be endorsed by the commander or senior leader of the requesting activity

and forwarded through their higher headquarters to the policy proponent. Refer to AR 25-30 for specific guidance.

**Suggested improvements.** Users are invited to send in comments and suggested improvements to this regulation. Internet users can submit their comments and suggested improvements using the electronic version of DA Form 2028 (Recommended Changes to Publications and Blank Forms) found within the individual Deputy Chief of Staff, G-4 regulation and pamphlet. Anyone without Internet access should submit their comments and suggested improvements on a DA Form 2028 directly to Deputy Chief of Staff, G-4, ATTN: DALO-SMM, 500 Army Pentagon, Washington, DC 20310-0500.

**Distribution.** This publication is available in electronic media only and is intended for command levels A, B, C, D, and E, for the Active Army, the Army National Guard of the United States, and the U.S. Army Reserve.

---

## Contents (Listed by paragraph and page number)

### Chapter 1

Introduction, *page 1*

Purpose • 1-1, *page 1*

References • 1-2, *page 1*

Explanation of abbreviations and terms • 1-3, *page 1*

Exceptions • 1-4, *page 1*

Army-wide use of TAMMS • 1-5, *page 1*

TAMMS history, current organization, and future • 1-6, *page 1*

TAMMS policy foundation and applicability • 1-7, *page 2*

TAMMS processes, forms, records, and reports • 1-8, *page 2*

---

\*This pamphlet supersedes DA Pam 750-8, dated 25 February 2005.

## **Contents—Continued**

General instructions for units/activities with maintenance STAMIS and units/activities following manual procedures only • 1–9, *page 3*

### **Chapter 2**

#### **Operational Processes, Forms, Records and Dispatch Procedures, *page 4***

General procedures • 2–1, *page 4*  
Equipment dispatching: automated procedures • 2–2, *page 5*  
Equipment dispatching: manual procedures • 2–3, *page 6*  
Maintenance operation processes • 2–4, *page 6*  
Equipment data updates • 2–5, *page 7*  
Equipment data reports • 2–6, *page 7*  
Operator records/equipment class codes • 2–7, *page 8*  
Equipment record folder • 2–8, *page 8*  
DA Form 5823 • 2–9, *page 8*  
DA Form 5987–E/DA Form 5987–1–E • 2–10, *page 8*  
DD Form 1970 • 2–11, *page 9*  
DA Form 5982–E/DA Form 2401 • 2–12, *page 10*

### **Chapter 3**

#### **Maintenance Processes, Forms and Records, *page 34***

General • 3–1, *page 34*  
Maintenance reporting and AMSS • 3–2, *page 35*  
Maintenance control file (non-ULLS/manual input) • 3–3, *page 35*  
Organization work order number • 3–4, *page 35*  
DA Form 5409 and DA Form 5410 • 3–5, *page 36*  
ULLS to SAMS interfaces (unit using procedures) • 3–6, *page 37*  
Equipment data reports • 3–7, *page 37*  
DA Form 2402 (Maintenance Tag) • 3–8, *page 38*  
DD Form 314 • 3–9, *page 38*  
DA Form 5988–E and DA Form 2404 (Equipment Inspection and Maintenance Worksheet) • 3–10, *page 42*  
DA Form 5989–E/AHN007/DA Form 2405 (Maintenance Request Register) • 3–11, *page 44*  
DA Form 3999–4 (Maintenance Work Request Envelope) • 3–12, *page 45*  
DA Form 5990–E (Maintenance Request) • 3–13, *page 45*  
DA Forms 2407/2407–1 • 3–14, *page 46*  
DA Forms 2407/2407–1 used to request or report an MWO • 3–15, *page 47*  
Warranty claim action • 3–16, *page 48*  
DA Forms 2407 and 2407–1 (serial number tracking implementation within SAMS) • 3–17, *page 50*  
Reporting requirements • 3–18, *page 51*  
DA Form 2408–14 • 3–19, *page 51*  
FAA Form 6030–1 • 3–20, *page 52*  
Manager reports • 3–21, *page 53*  
Selected SAMS output reports • 3–22, *page 53*

### **Chapter 4**

#### **AOAP Nonaeronautical Equipment, Processes, Forms, Records, and Procedures, *page 124***

AOAP objectives • 4–1, *page 124*  
Description • 4–2, *page 124*  
AOAP participation • 4–3, *page 125*  
What to sample • 4–4, *page 125*  
When to sample • 4–5, *page 125*  
Maintenance feedback data • 4–6, *page 125*

### **Chapter 5**

#### **Historical Processes, Forms, Records and Procedures Report Control Symbol (RCS) 1051, *page 130***

General information • 5–1, *page 130*

## **Contents—Continued**

Missing historical information or records • 5–2, *page 130*  
DA Form 2408–4 • 5–3, *page 130*  
DA Form 2408–4 used for recording armament system and subsystems • 5–4, *page 131*  
DA Form 2408–5 (Equipment Modification Record) • 5–5, *page 132*  
Usage reporting through ULLS-G • 5–6, *page 133*  
DA Form 2408–9 • 5–7, *page 133*  
DA Form 2408–20 (Oil Analysis Log) • 5–8, *page 140*  
DD Form 1650 (Ammunition Data Card) • 5–9, *page 140*  
Equipment logbook binder (historical records) • 5–10, *page 140*  
Records that go with equipment • 5–11, *page 141*

### **Chapter 6**

#### **Watercraft and Amphibious Lighters Records and Procedures, *page 165***

General • 6–1, *page 165*  
Reporting of accidents/incidents • 6–2, *page 166*  
Component record • 6–3, *page 166*  
Request for disposition and/or waiver • 6–4, *page 167*

### **Chapter 7**

#### **Rail Equipment Records and Procedures, *page 171***

General rail equipment forms • 7–1, *page 171*  
Preparation of forms • 7–2, *page 172*  
DD Form 862 (Daily Inspection Worksheet for Diesel Electronic Locomotives and Locomotive Cranes) • 7–3, *page 172*  
DD Form 1335 • 7–4, *page 172*  
Form FRA F6180–49A • 7–5, *page 172*

### **Chapter 8**

#### **Ammunition Records and Reporting Procedures, *page 179***

Records and reports • 8–1, *page 179*  
Special instructions • 8–2, *page 179*  
General instructions • 8–3, *page 180*  
DA Form 2415 (Ammunition Condition Report) (RCS CSGLD–1202) • 8–4, *page 180*  
ACR submission flow and preparation • 8–5, *page 181*

### **Chapter 9**

#### **Supply and Maintenance Assessment and Review Team (SMART), *page 184***

General • 9–1, *page 184*  
Procedures • 9–2, *page 184*

### **Chapter 10**

#### **Submitting Equipment Improvement Reports and Product Quality Deficiency Reports and Reporting Initial Failure of Stock-Funded, Depot-Level Repairables, *page 184***

Reporting • 10–1, *page 184*  
Use and preparation of an SF 368 • 10–2, *page 185*  
Exhibits • 10–3, *page 187*  
Addresses for the SF 368 • 10–4, *page 187*  
Reporting initial failure of SFDLR • 10–5, *page 187*

## **Appendixes**

- A.** References, *page 201*
- B.** Codes and Conversion Tables, *page 208*
- C.** Warranty Control offices and Logistics Assistance Offices, *page 239*
- D.** Julian/Ordinal Date Calendar, *page 245*

## Contents—Continued

### E. Department of the Army List of Items on Which Historical Records are to be Maintained, *page 247*

#### Table List

- Table 3-1: DD Form 314 requirements, *page 40*  
Table 3-2: Warranty claim addresses, *page 49*  
Table 3-3: List of SNT reportable items, *page 50*  
Table 5-1: Data input format (acceptance and registration) code “G”, *page 134*  
Table 5-2: Data input format (acceptance and registration) trailer (card code “H”), *page 135*  
Table 5-3: Data input format (usage or overhaul) code “J”, *page 136*  
Table 5-4: Data input format (transfer, gain, or loss) code “K”, *page 137*  
Table 5-5: Data input format (repair action) code “M”, *page 138*  
Table 10-1: Army screening points, *page 186*  
Table B-1: Failure codes, alphabetical, *page 208*  
Table B-2: Failure codes, numerical, *page 212*  
Table B-3: Failure detected during codes, *page 217*  
Table B-4: First indication of trouble codes, *page 217*  
Table B-5: Action codes, *page 217*  
Table B-6: Utilization codes, *page 218*  
Table B-7: Time conversion codes, *page 219*  
Table B-8: Equipment repair action code, *page 220*  
Table B-9: Miscellaneous codes, *page 220*  
Table B-10: NRTS (not reparable this station) codes, *page 220*  
Table B-11: Vehicle use codes, *page 221*  
Table B-12: Equipment acceptance codes, *page 221*  
Table B-13: Equipment usage codes, *page 221*  
Table B-14: Equipment transfer codes, *page 221*  
Table B-15: Equipment loss codes, *page 221*  
Table B-16: Equipment gain codes, *page 222*  
Table B-17: Equipment overhaul code, *page 222*  
Table B-18: Equipment category codes (ECC), *page 222*  
Table B-19: The metric system and equivalents, *page 234*  
Table B-20: Type maintenance request codes (Type MNT Req CD), *page 234*  
Table B-21: Work request status code, *page 235*  
Table B-22: Work request NMC indicator codes, *page 237*  
Table B-23: NMC time for AMSS reporting, *page 237*  
Table B-24: Level of work codes, *page 238*  
Table B-25: Operational readiness float (ORF) transaction codes, *page 238*  
Table C-1: Warranty control offices, *page 239*  
Table C-2: Supporting logistics assistance offices, *page 240*  
Table D-1: Julian/ordinal date calendar (perpetual), *page 246*

#### Figure List

- Figure 2-1: Sample DA Form 348 (front), *page 11*  
Figure 2-1: Sample DA Form 348, *page 14*  
Figure 2-2: Sample ULLS-generated AWC MF417 (Equipment Availability Report), *page 15*  
Figure 2-3: Sample ULLS-generated AWC MF458 (Non-Mission Capable Report), *page 16*  
Figure 2-4: Sample ULLS-generated DA Form 5985-E (Class Codes), *page 17*  
Figure 2-5: Sample ULLS-generated DA Form 5984-E, *page 18*  
Figure 2-6: Sample DA Form 5823, *page 19*  
Figure 2-7: Sample ULLS-generated DA Form 5987-E, *page 21*  
Figure 2-8: Sample ULLS-generated DA Form 5987-E-1, *page 23*  
Figure 2-9: Sample DD Form 1970 for dispatch, *page 26*  
Figure 2-10: Sample DD Form 1970 for extended dispatch, *page 29*  
Figure 2-11: Sample DD Form 1970 for operating time, *page 31*



## Contents—Continued

- Figure 2–12: Sample ULLS-generated DA Form 5982–E, *page 32*
- Figure 2–13: Sample DA Form 2401, *page 34*
- Figure 3–1: Sample DA Form 5409, *page 55*
- Figure 3–2: Sample DA Form 5409 (change), *page 56*
- Figure 3–3: Sample DA Form 5409 (deletion/closeout), *page 56*
- Figure 3–4: Sample DA Form 5410, *page 58*
- Figure 3–5: Sample DA Form 5410 (receipts and correction), *page 59*
- Figure 3–6: Sample DA Form 5410 (delete), *page 60*
- Figure 3–7: Sample SAMS–1 Work Order Detail Report, *page 61*
- Figure 3–8: Sample ULLS-Generated Parts Received Not Installed Report, *page 62*
- Figure 3–9: Sample ULLS-Generated Service Schedule, *page 63*
- Figure 3–10: Sample DA Form 2402, *page 64*
- Figure 3–11: Sample System DD Form 314, *page 65*
- Figure 3–12: Sample DD Form 314, subsystem (B2/B1) (front), *page 66*
- Figure 3–13: Sample DD Form 314 subsystem (back), *page 67*
- Figure 3–14: Sample DD Form 314 subsystem with components (back), *page 68*
- Figure 3–15: Sample DD Form 314 system (B1) (back), *page 69*
- Figure 3–16: Sample Form DD 314 system B1 (front), *page 70*
- Figure 3–17: Sample DD Form 314 used for equipment end item, *page 71*
- Figure 3–18: Sample DD Form 314 used to record more than one serial number, *page 72*
- Figure 3–19: Sample DD Form 314 component card, *page 73*
- Figure 3–20: DD Form 314 flow chart, *page 74*
- Figure 3–21: Sample DD Form 314 used for system B2 requirements, *page 75*
- Figure 3–22: Sample DD Form 314 used for system B1 requirements, *page 76*
- Figure 3–23: Sample DD Form 314 used for equipment end items and component requirements, *page 76*
- Figure 3–24: Sample DA Form 5988–E used for operator/crew PMCS, *page 78*
- Figure 3–25: Sample DA Form 2404 used for operator/crew PMCS (fault noted), *page 80*
- Figure 3–26: Sample DA Form 2404 used for services on more than one like item, *page 83*
- Figure 3–27: Sample ULLS-generated DA Form 5988–E used for maintenance services and inspections, *page 83*
- Figure 3–28: Sample DA Form 2404 used for maintenance services and inspections, *page 85*
- Figure 3–29: Sample ULLS-generated DA Form 5988–E used for changing “X” condition, *page 88*
- Figure 3–30: Sample DA Form 2404 used for changing "X" condition, *page 90*
- Figure 3–31: Sample DA Form 2404 used for BDAR, *page 91*
- Figure 3–32: Sample DA Form 2404 used for ECOD (front), *page 92*
- Figure 3–32: Sample DA Form 2404 used for ECOD (back), *page 94*
- Figure 3–33: Sample ULLS-generated DA Form 5989–E, *page 95*
- Figure 3–34: Sample DA Form 2405, *page 96*
- Figure 3–35: Sample DA Form 3999–4, *page 98*
- Figure 3–36: Sample ULLS-generated DA Form 5990–E, *page 99*
- Figure 3–37: Sample DA Form 2407 used to request support maintenance, *page 102*
- Figure 3–38: Sample DA Form 2407 used for ECOD, *page 105*
- Figure 3–39: Sample DA Form 2407 used to request an MWO, *page 106*
- Figure 3–40: Sample DA Form 2407 used to document an MWO, *page 109*
- Figure 3–41: Sample DA Form 2407 used for warranty claim actions, *page 112*
- Figure 3–42: Sample DA Form 2407 used for serial number tracking, *page 114*
- Figure 3–43: Sample DA Form 2407–1, *page 116*
- Figure 3–44: Sample of a DA Form 2408–14, *page 117*
- Figure 3–45: Sample ULLS-generated AWCSF176, *page 117*
- Figure 3–46: Sample ULLS-generated AWCMF450 Report, *page 118*
- Figure 3–47: Sample ULLS-generated Commander’s Financial Transaction Listing, *page 119*
- Figure 3–48: Sample SAMS–1 Customer Work Order Reconciliation, *page 121*
- Figure 3–49: Sample SAMS–2 Equipment Deadlined Over NNN Days by Battalion, *page 122*
- Figure 3–50: Sample SAMS–2 Work Order Status and Parts, *page 123*
- Figure 3–51: Sample SAMS–2 Maintenance Cost by Customer, *page 124*
- Figure 4–1: Sample ULLS-generated DA Form 5991–E, *page 126*

## Contents—Continued

- Figure 4–2: DD Form 2026, *page 128*  
Figure 4–3: DA Form 3254, *page 129*  
Figure 5–1: Sample DA Form 2408–4, *page 143*  
Figure 5–2: Sample DA Form 2408–4 with information to keep when sending a DA Form 2408–4, *page 144*  
Figure 5–3: Sample DA Form 2408–4 used for boresight and zero, *page 145*  
Figure 5–4: Sample DA Form 2408–4 used for a 25mm automatic gun, *page 146*  
Figure 5–5: Sample DA Form 2408–4 used for the Air Defense Weapon System, *page 147*  
Figure 5–6: Sample DA Form 2408–5, *page 148*  
Figure 5–7: Sample DA Form 2408–9 used for acceptance and registration, *page 149*  
Figure 5–8: Sample DA Form 2408–9 used to record usage, *page 151*  
Figure 5–9: Sample DA Form 2408–9 used to record transfer, *page 153*  
Figure 5–10: Sample DA Form 2408–9 used to record loss, *page 155*  
Figure 5–11: Sample DA Form 2408–9 used to record gain, *page 156*  
Figure 5–12: Sample DA Form 2408–9 used to record repair, *page 158*  
Figure 5–13: Sample DA Form 2408–9 used to record overhaul, *page 159*  
Figure 5–14: Sample DA Form 2408–9 used to record NSN change, *page 161*  
Figure 5–15: Sample DA Form 2408–20 (front), *page 162*  
Figure 5–15: Sample DA Form 2408–20 (back), *page 164*  
Figure 5–16: Sample DD Form 1650 (front), *page 164*  
Figure 5–16: Sample DD Form 1650 (back)—Continued, *page 165*  
Figure 6–1: Sample DA Form 5587 (front), *page 168*  
Figure 6–1: Sample DA Form 5587 (reverse), *page 171*  
Figure 7–1: Sample DD Form 862 (front), *page 173*  
Figure 7–1: Sample DD Form 862 (back)—Continued, *page 175*  
Figure 7–2: Sample DD Form 1335, *page 177*  
Figure 7–3: Sample Form FRA F6180–49A, *page 179*  
Figure 8–1: Sample DA Form 2415, *page 183*  
Figure 10–1: Sample SF 368 used to report equipment deficiencies, *page 191*  
Figure 10–2: Sample SF 368 used to report computer software deficiencies, *page 193*  
Figure 10–3: Sample Category I SF 368 message format, *page 194*  
Figure 10–3: Sample Category I SF 368 message format, *page 195*  
Figure 10–3: Sample Category I SF 368 message format, *page 198*  
Figure 10–4: Sample DD Form 1575, *page 198*  
Figure 10–5: Sample DD Form 2332 (front), *page 199*  
Figure 10–5: Sample DD Form 2332 (back), *page 200*  
Figure E–1: Identification of required forms for missile systems, *page 249*  
Figure E–1: Identification of required forms for missile systems—Continued, *page 249*  
Figure E–1: Identification of required forms for missile systems—Continued, *page 250*  
Figure E–1: Identification of required forms for missile systems—Continued, *page 250*  
Figure E–1: Identification of required forms for missile systems—Continued, *page 251*  
Figure E–1: Identification of required forms for missile systems—Continued, *page 251*  
Figure E–2: Identification of required forms for combat/tactical vehicles and support equipment, *page 252*  
Figure E–2: Identification of required forms for combat/tactical vehicles and support equipment—Continued, *page 252*  
Figure E–2: Identification of required forms for combat/tactical vehicles and support equipment—Continued, *page 253*  
Figure E–2: Identification of required forms for combat/tactical vehicles and support equipment—Continued, *page 253*  
Figure E–2: Identification of required forms for combat/tactical vehicles and support equipment—Continued, *page 254*  
Figure E–2: Identification of required forms for combat/tactical vehicles and support equipment—Continued, *page 254*  
Figure E–2: Identification of required forms for combat/tactical vehicles and support equipment—Continued, *page 255*





## Contents—Continued

- Figure E-2: Identification of required forms for combat/tactical vehicles and support equipment—Continued, *page 283*
- Figure E-3: Identification of required forms for railway equipment, *page 284*
- Figure E-3: Identification of required forms for railway equipment—Continued, *page 284*
- Figure E-3: Identification of required forms for railway equipment—Continued, *page 285*
- Figure E-3: Identification of required forms for railway equipment—Continued, *page 285*
- Figure E-4: Identification of required forms for nontactical wheeled vehicles and special purpose, *page 286*
- Figure E-4: Identification of required forms for nontactical wheeled vehicles and special purpose—Continued, *page 286*
- Figure E-4: Identification of required forms for nontactical wheeled vehicles and special purpose—Continued, *page 287*
- Figure E-4: Identification of required forms for nontactical wheeled vehicles and special purpose—Continued, *page 287*
- Figure E-4: Identification of required forms for nontactical wheeled vehicles and special purpose—Continued, *page 288*
- Figure E-4: Identification of required forms for nontactical wheeled vehicles and special purpose—Continued, *page 288*
- Figure E-4: Identification of required forms for nontactical wheeled vehicles and special purpose—Continued, *page 289*
- Figure E-4: Identification of required forms for nontactical wheeled vehicles and special purpose—Continued, *page 289*
- Figure E-4: Identification of required forms for nontactical wheeled vehicles and special purpose—Continued, *page 290*
- Figure E-4: Identification of required forms for nontactical wheeled vehicles and special purpose—Continued, *page 290*
- Figure E-4: Identification of required forms for nontactical wheeled vehicles and special purpose—Continued, *page 291*
- Figure E-4: Identification of required forms for nontactical wheeled vehicles and special purpose—Continued, *page 291*
- Figure E-4: Identification of required forms for nontactical wheeled vehicles and special purpose—Continued, *page 292*
- Figure E-4: Identification of required forms for nontactical wheeled vehicles and special purpose—Continued, *page 292*
- Figure E-4: Identification of required forms for nontactical wheeled vehicles and special purpose—Continued, *page 293*
- Figure E-4: Identification of required forms for nontactical wheeled vehicles and special purpose—Continued, *page 293*
- Figure E-4: Identification of required forms for nontactical wheeled vehicles and special purpose—Continued, *page 294*
- Figure E-4: Identification of required forms for nontactical wheeled vehicles and special purpose—Continued, *page 294*
- Figure E-4: Identification of required forms for nontactical wheeled vehicles and special purpose—Continued, *page 295*
- Figure E-4: Identification of required forms for nontactical wheeled vehicles and special purpose—Continued, *page 295*
- Figure E-4: Identification of required forms for nontactical wheeled vehicles and special purpose—Continued, *page 296*

## Glossary



## **Chapter 1 Introduction**

### **1-1. Purpose**

The purpose of the Army Maintenance Management System (TAMMS) is to assist commanders at all levels in managing equipment use and operations, equipment maintenance, and repair operations and to maintain equipment to the Army standard as outlined in Army Regulation (AR) 750-1. It also provides the foundation for materiel condition status reporting (MCSR) as outlined in AR 700-138 and controlling equipment as outlined in AR 600-55.

*a.* TAMMS is a comprehensive management information system, consisting of automated information components and records, manually maintained components and records, and a central Army database at Logistics Support Activity (LOGSA). This central database is the Maintenance Module of the Logistics Integrated Database and is used by all Army commands.

*b.* TAMMS uses a set of time-proven maintenance processes, engineering practices, and industry standards. The TAMMS processes and maintenance records enable commanders to manage equipment readiness, availability, and durability, based on the level of resources provided by higher command. Resources include the application of time, trained personnel, tools, test equipment, and funds.

### **1-2. References**

Required and related publications and prescribed and referenced forms are listed in appendix A.

### **1-3. Explanation of abbreviations and terms**

Abbreviations and special terms used in this regulation are explained in the glossary.

### **1-4. Exceptions**

This pamphlet cannot be supplemented or changed without approval from Headquarters, Department of the Army (HQDA), Office of the Deputy Chief of Staff, G-4, Maintenance Policy Division (DALO-SMM), Washington DC 20310-0500. Requested exceptions are reviewed and approved annually.

### **1-5. Army-wide use of TAMMS**

Commanders, leaders, equipment operators, and maintenance personnel at all levels of command, for all equipment commodities, use TAMMS. All Army or Army affiliated personnel who use, maintain, or repair Army equipment use TAMMS. This includes contractors and vendors, as specified by applicable provisions of Army contracts. All commanders use TAMMS to control equipment operations, and manage its maintenance and upkeep. Commanders in U.S. Army major commands and other Army support echelons use TAMMS data, records, and reports to provide assistance and support to Army field commands.

### **1-6. TAMMS history, current organization, and future**

*a.* During the early 1980s, the Army automated selected portions of TAMMS, then an entirely manual maintenance management system of paper forms and records. Most Army organizations recognize these automated portions of TAMMS as the Unit Level Logistics System (ULLS), used at the unit level of operations, and the Standard Army Maintenance System (SAMS), used at direct support and general support levels of maintenance operations. Both ULLS and SAMS are Standard Army Management Information Systems (STAMIS).

*b.* As of 2004, the TAMMS data records and forms are categorized into operational records, maintenance records, and historical records to provide a logical system of tracking the numerous tasks required to operate, maintain, repair, and report the status of Army equipment. In organizations that use and are authorized ULLS and SAMS, some manual, paper-based TAMMS procedures remain. Some Army organizations have not yet made the transition from a manual TAMMS operation to a STAMIS-supported maintenance management environment. This pamphlet is intended to provide guidance to all Army organizations.

*c.* TAMMS is being transformed to its future configuration, in accordance with the Army Transformation Campaign Plan, from its form-based historical roots to a data-centric management information system. The essential maintenance and logistics data elements, found in current TAMMS manual and automated records, will be used in a modern hardware/software system to assist commanders in accomplishing their missions and to comply with Army maintenance policy.

*d.* The future TAMMS will combine the functionality of Unit Level Logistics System-Ground (ULLS-G) and SAMS-1, SAMS-2, and SAMS-I/table of distribution and allowances (TDA) into SAMS enhanced or SAMS-E, allowing for common equipment service capability and tracking, work order capability, readiness and availability reporting, and repair parts management, and will add new functionality. This system will provide the required management tracking tools to provide thorough historical maintenance data on equipment end items, components, and subassemblies for proper analysis.

*e.* Today's forms will be replaced with automatic identification technology (AIT) that will be placed on components, designated subassemblies, and end items. A redundant file will be maintained in the automation management system

data files with selective data transmitted to the Army designated database for analysis and programming of resources. TAMMS will become the maintenance module of the Global Combat Support System—Army (GCSSA).

f. Mechanics and technicians will use maintenance support devices with interactive electronic technical manuals (IETMs) as the initial entry point for all maintenance actions into the Army maintenance module. These devices are capable of interfacing with equipment end items via a digital source collector or data bus using a single port low-power radio frequency device. The IETM will be capable of running embedded and off-platform diagnostics programs, interfacing with AIT devices for information, processing work orders, managing service actions, requesting parts, and reviewing training for maintenance tasks via animation, video clips, or digital pictures. These devices are core requirements to reduce repair cycle time and support costs.

g. The Maintenance Module focuses on the following core processes:

- (1) Dispatching (including remote dispatching).
- (2) Management of equipment and component services.
- (3) Fault repair (including fault diagnosis using embedded diagnostics and prognostics).
- (4) Repair parts management requisitioning.
- (5) Materiel status reporting (including health monitoring).
- (6) Man-hour management and reporting (all maintainers, organizational direct support/ general support (DS/GS)).
- (7) Work-order management.

h. The Maintenance Module ensures that the following support processes are included:

- (1) Management of equipment modifications.
- (2) Serial number tracking for designated components, subassemblies, and equipment items.
- (3) Equipment usage reporting.
- (4) Army Oil Analysis Program (AOAP) management.
- (5) Weapons data management.
- (6) Quality control management.
- (7) Product quality deficiency reporting.
- (8) Safety-of-use messages and advisories management.
- (9) Licensing management.
- (10) Configuration management.
- (11) Test, measurement, and diagnostic equipment (TMDE) calibration management.

### **1-7. TAMMS policy foundation and applicability**

a. AR 600-55 establishes Army policy for the selection and training of Army drivers. AR 750-1 establishes policy for maintenance of Army equipment. This pamphlet outlines the procedures, forms, source documents, and records to be used to execute that policy.

b. This pamphlet applies to all Army equipment, except aviation equipment (see Department of the Army (DA) Pamphlet (Pam) 738-751), installed equipment (see AR 420-18), industrial production equipment, nonstandard equipment that has not been type classified or assigned a national stock number (NSN), equipment bought with nonappropriated funds, and medical equipment covered by Technical Bulletin (TB) 38-750-2.

c. TAMMS procedures apply to the following broad equipment management areas:

- (1) Equipment use, maintenance, and repair.
- (2) Equipment improvement recommendations (EIRs) and Product Quality Deficiency Reports (PQDRs).
- (3) Modification work orders (MWOs).
- (4) Reporting the condition, status, and operation of equipment.
- (5) Collection and reporting information used to design new equipment and redesign and improve current equipment.

(6) Collection of information for special one-time studies and projects, and in support of Army sample data collection (SDC) missions and activities. SDC missions and activities are defined in AR 750-1.

(7) File warranty claim actions (WCAs).

### **1-8. TAMMS processes, forms, records, and reports**

a. *General.*

(1) *Operational processes, forms, records, and dispatch procedures.* Operational processes, forms, records and dispatch procedures provide the required information for dispatching Army equipment. Operational processes, forms, records and dispatch procedures are in chapter 2.

(2) *Maintenance processes, forms, records, and procedures.* Maintenance processes, forms records, and procedures provide the required information for maintenance schedules and services, inspections, warranty claim actions, and repair workloads and are used to report, request, and record repair work. Maintenance processes, forms, records and procedures are in chapter 3.



(3) *Historical processes, forms, records and procedures.* Historical processes, forms, records and procedures provide the required information that document specified events in the life of equipment and components that include equipment transfers, gains, losses, usage, NSN redesignations, rebuilds, vehicle overhauls, firing data on weapons and modifications. Historical processes, forms, records and procedures are in chapter 5.

*b. Commodity specific records and reports.*

(1) *Watercraft and amphibious lighters records and procedures.* Records and procedures for U.S. Army floating craft are in chapter 6.

(2) *Rail equipment records and procedures.* Records and procedures for U.S. Army rail equipment are in chapter 7.

(3) *Ammunition records and procedures.* Use ammunition records and procedures to control and report on munitions. Ammunition records and procedures are in chapter 8.

*c. Other records and reports.*

(1) *Nonaeronautical Equipment, AOAP.* Technical information, instructions, and operating procedures for non-aeronautical equipment enrolled in the AOAP are described in chapter 4. Policies, objectives, and responsibilities of the AOAP are prescribed in AR 750-1.

(2) *Deficiency reports.* Procedures to report equipment improvements (EIRs), Product Quality Deficiency Reports (PQDRs), and initial failure of stock-funded, depot-level repairables (SFDLR) are in chapter 10.

### **1-9. General instructions for units/activities with maintenance STAMIS and units/activities following manual procedures only**

*a. Units authorized and using an Army Maintenance STAMIS.*

(1) As noted in paragraph 1-6a, TAMMS is not a fully automated management information system. Some manually prepared forms and records are required, even for those Army units that are authorized a STAMIS. Procedures related to these manual forms and records are outlined in paragraph 1-6a.

(2) The TAMMS electronic forms and records covered in the STAMIS take precedence over the equivalent manually prepared forms and records covered elsewhere in this pamphlet. When procedures of the STAMIS disagree with the procedures in this pamphlet, follow the STAMIS procedures.

(3) Some equipment operations and maintenance procedures are not automated by the maintenance STAMIS. For these requirements, the manual forms and records procedures outlined in chapters 2 through 10 of this pamphlet are used.

(4) Units or activities that are ULLS users should comply with Automated Information System Manual (AISM) 25-L3Q-AWC-ZZZ-EM (ULLS End User Manual) and chapters 2, 3, 4, and 5 of this pamphlet. ULLS provides automated procedures for performing and managing limited TAMMS functions and standard maintenance facility operations. The forms automated through ULLS are authorized for use.

(5) Units or activities operating under SAMS use the procedures outlined in the appropriate SAMS AISMs 25-L21-AHN-ZZZ-EM, 25-L26-AHO-ZZZ-EM, and 25-L2S-AHR-HPC-EM (F) and chapter 3 of this pamphlet. SAMS provides automated procedures for performing and managing limited TAMMS functions for DS/GS maintenance shop operations. The forms automated through SAMS are authorized for use.

(6) Information about *automated* forms and records and specific details on how to prepare, use, and handle each form or record are found in the related chapter noted in paragraph 1-9c. Information on each form or record must be readable, correct, and complete. Unless specific instructions for the form indicate otherwise, the following rules apply:

(a) Nonapplicable entries are left blank.

(b) Only the authorized codes are used for forms listed in appendix B of this pamphlet.

(c) The examples and illustrations are used as guides only. The text and figure instructions must be read and then forms showing equipment, unit, and status are filled in appropriately. If there is a conflict between the form and the instructions in the figure, the instructions should be followed.

(d) Commanders may appoint a representative to authenticate/sign some forms and records. When a representative is appointed, that authority must be in writing on a memorandum, in orders, or on a DA Form 1687 (Notice of Delegation of Authority—Receipt for Supplies) (see DA Pam 710-2-1).

(e) Commanders should comply with the disposition instructions provided for each TAMMS form or record. A form/record may be retained in the unit beyond the prescribed period when required locally to assist management or in special situations. A form is not retained beyond the prescribed time merely for inspection purposes.

*b. Units or activities not authorized or using an Army maintenance STAMIS.*

(1) If unit is not operating an Army maintenance STAMIS, the manual forms and records outlined in this pamphlet are used.

(2) Information about *manual* forms and records and specific details on how to prepare, use, and handle each form or record are found in the related chapter noted in paragraph 1-9. Information on each form or record must be readable, correct, and complete. Unless specific instructions for the form indicate otherwise, the following rules apply:

(a) Nonapplicable entries are left blank.

(b) Only the authorized codes are used for forms listed in appendix B of this pamphlet.

(c) The examples and illustrations should be used as guides only. Read the text and figure instructions, then fill out the forms showing your unit, equipment, and status. If there is a conflict between the form and the instructions in the figure, use the instructions.

(d) Commanders may appoint a representative to authenticate/sign some forms and records. When a representative is appointed, that authority must be in writing on a memorandum, on orders, or on a DA Form 1687 (see DA Pam 710-2-1).

(e) Commanders comply with the disposition instructions provided for each TAMMS form and record. A form/record may be retained in the unit beyond the prescribed period when required locally to assist management or in special situations. A form is not be retained beyond the prescribed time merely for inspection purposes.

*c. General guidance on preparing manual forms.*

(1) The required forms and records provide a picture of the equipments condition, use, operation, and needs. The ultimate purpose of this information is to have the equipment safe and ready for combat.

(2) Operators, dispatchers, records clerks, mechanics, prescribed load list clerks, supervisors, and commanders have an equal stake in maintaining the forms.

(3) The forms and records are not redone just for neatness. Redo historical forms and records, as shown below, only when the original form is lost or so damaged that the information is no longer readable.

(4) When a historical form is redone, move all the information from the old form to the new one. In the remarks block of the new form or in the top or bottom margin, print: New Form Initiated and the date. The commander or the commander's designated representative signs the entry. Enter UNK (unknown) in any block that cannot be read. Throw away the national maintenance point (NMP) copies of forms made to replace lost or damaged forms. See the following instructions.

(a) These instructions apply only when the original form was on hand but was lost or damaged.

(b) If equipment requiring a DA Form 2408-9 (Equipment Control Record) arrives in the unit without a form or there is no record of a DA Form 2408-9 on it, use the instructions in paragraph 5-2a.

(5) If a record is lost, damaged, falsified, or destroyed whether intentionally or through negligence, disciplinary action may result. These forms and records are required.

## **Chapter 2**

### **Operational Processes, Forms, Records and Dispatch Procedures**

#### **2-1. General procedures**

This chapter describes how to plan, manage, fill out and use forms for equipment operation, dispatch, and control of equipment when using ULLS-G or manual procedures.

a. The ULLS is the Army's Unit Level Logistics System. ULLS collects operator licensing, dispatch, and equipment control data and provides management information at the unit level.

b. The ULLS-G automates/replaces portions of TAMMS. Commanders ensure that portions of TAMMS not replaced by ULLS are accomplished using the manual procedures outlined in this pamphlet. The following DA forms/DD forms /optional forms (OF) have been automated, and ULLS-G generated printouts (shown with an -E) are authorized replacements:

(1) DA Form 5823 (not required if operating with ULLS-G; this information is on the dispatch printout).

(2) DA Form 5987-E (Motor Equipment Dispatch), DA Form 5987-1E (Alert Motor Equipment Dispatch), and DD Form 1970 (Motor Equipment Utilization Record).

(3) DA Form 5982-E (Dispatch Control Log) and DA Form 2401 (Organizational Control Record for Equipment).

(4) DA Form 5984-E (Operators Permit Record) (fig 2-5).

c. DA Form 348 (Equipment Qualification Record) is the only authorized record for documenting equipment operator's qualifications (fig 2-1). ULLS-G produces a Form 348-E that reflects equipment qualifications that have been locally transferred into ULLS-G from the DA Form 348; however, this is not an authorized replacement of DA Form 348. This process was designed to help streamline automated dispatch procedures through the use of a relational database. The ULLS-G generated Form 348-E does not provide the necessary documentation for a commander to make an appropriate determination for authorization of equipment use. Commanders document equipment qualifications using the DA Form 348 as prescribed in AR 600-55. Units maintain a copy of all authorized operator's DA Form 348s on file. The ULLS-G generated Form 348-E is used for local purposes only. Units review operator qualification information quarterly to ensure ULLS-G is synchronized with manning rosters and review training qualifications to ensure accuracy.

d. Units operating ULLS-G supersede all manual procedures. In cases where there is a conflict on form disposition between this pamphlet and the user manual, this pamphlet takes precedence.

e. All units, organizations, and activities that operate self-powered vehicles, towed vehicles, and stationary powered

equipment keep the data, reports, forms, and records. These management tools may be used for other equipment when the commander wants hours of use, fuel, and oil added or other information.

f. The following publications tell how to report accidents and train, test, and license equipment operators (except on aircraft):

- (1) AR 56–9.
- (2) AR 190–51.
- (3) AR 385–40.
- (4) AR 385–55.
- (5) AR 600–55.
- (6) AR 58–1.
- (7) FM 55–30.
- (8) FM 21–305.
- (9) TB 600–1.
- (10) TB 600–2.

## **2–2. Equipment dispatching: automated procedures**

a. Dispatching is the method by which a commander controls the use of equipment. However, allowing equipment to be used carries with it the responsibility for both the equipment and the operators safety. The commander must make sure that dispatching procedures are understood and followed.

b. The commander appoints a responsible person to the duties of dispatcher. The person that is delegated as dispatcher is provided a password, and given access to ULLS. In the absence of the appointed dispatcher, the commander must authorize additional dispatchers in writing.

c. The dispatcher—

- (1) Fills requests for equipment to be issued or used.
- (2) Ensures the operator is registered as a licensed, qualified operator within ULLS. If the operator is not registered in ULLS, check for a valid DA Form 5984–E and update ULLS, as appropriate.
- (3) Issues and collects the Equipment Record Folder and the needed forms in the folder.
- (4) Ensures that the operators properly annotate required entries on the forms and printouts contained in the Equipment Record Folder.
- (5) Makes required entries on the dispatch input screen.
- (6) Ensures equipment faults are reported to maintenance personnel.
- (7) Records services performed during the dispatch (for example, AOAP samples taken) and updates ULLS accordingly.

d. The dispatch loop describes the procedures to be followed when dispatching equipment:

(1) The operator reports to the dispatcher. For equipment needing licensed operators, the operator must be licensed to operate the equipment either within ULLS or have a valid DA Form 5984–E.

(2) The dispatcher gives the operator an Equipment Record Folder with all the forms and printouts needed during the mission. Both the dispatcher and operator check the dispatch for services due on equipment.

(3) The operator uses the equipment TM to perform BEFORE operation preventive maintenance checks and services (PMCS). Any faults that the operator finds that can be repaired at that level are repaired. Other faults, not already recorded, are entered on the equipment inspection/maintenance worksheet. Nontactical equipment may not have a PMCS. The operator uses a local checklist as a PMCS for that equipment. BEFORE operational checks and services are performed before the equipment leaves the maintenance facility or other dispatch point. DURING operational checks are performed while the equipment is being operated. AFTER operational checks and services are performed when the equipment completes the mission or returns to the maintenance facility or dispatch point.

(4) If possible, the operator and/or mechanic repairs faults found on the equipment. The commander or commanders representative decides if any remaining faults are keeping the equipment from being dispatched.

(5) If equipment is ready to dispatch, the dispatcher makes necessary entries in ULLS.

(6) The operator leaves with the equipment and the Equipment Record Folder, which contains all needed forms and printouts. For routine dispatch, a vehicles folder should contain the current equipment maintenance and inspection worksheet, dispatch printout, and the accident forms: Standard Form (SF) Form 91 (Motor Vehicle Accident Report) and DD Form 518 (Accident Identification Card).

(7) When the mission is complete, the operator performs the AFTER operation PMCS on the equipment, and annotates new faults on DA Form 5988–E (Equipment Maintenance and Inspection Worksheet). The operator and mechanic fix any faults they can, and secure the equipment.

(8) The operator turns in the Equipment Record Folder and all forms and printouts to the dispatcher. The dispatcher checks forms for any new faults and updates ULLS maintenance records. The dispatch is closed using the operational processes menu, motor equipment dispatch and return.

(9) Motor transport units performing line-haul operations transfer their semitrailers to a larger organization designated by the senior motor transportation command (either group or brigade). The commander of the larger transport organization establishes a semitrailer control office responsible for maintaining dispatch and maintenance records on those semitrailers.

### **2-3. Equipment dispatching: manual procedures**

a. Dispatching is the method by which a commander controls the use of equipment. However, allowing equipment to be used carries with it the responsibility for both the equipment and the operators safety. Commanders ensure that dispatching procedures are understood and followed.

b. The commander appoints a responsible person to the duties of a dispatcher.

c. The dispatcher—

- (1) Fills requests for equipment to be issued or used.
- (2) Checks the operator's DA Form 5984-E to make sure the operator is licensed for the equipment requested.
- (3) Issues and collects required forms from the equipment record folder.
- (4) Ensures that the operators make needed and correct entries on the forms in the equipment record folder.
- (5) Logs equipment in and out on DA Form 2401.
- (6) Makes required entries on DD Form 1970.
- (7) Ensures equipment faults are reported to maintenance personnel using DA Form 2404.
- (8) Reports any differences in stated and actual destinations or missions.
- (9) Notes any completed services during the dispatch, AOAP samples taken, and so on. Updates DA Form 5823 to show any new information.

d. The dispatch loop describes the following procedures to be followed when dispatching equipment:

(1) The operator reports to the dispatcher. For equipment needing licensed operators, the operator's DA Form 5984-E lists or covers the item.

(2) The dispatcher gives the operator an equipment record folder with all the forms needed during the mission. Both the dispatcher and the operator check DA Form 5823 on the front of the folder for services due on the equipment. For unusual dispatch situations such as field training exercises or alerts, forms and packets are prepared in advance.

(3) The operator uses the equipment TM for before-operation PMCS. Any faults the operator can fix are fixed. Other faults, not already on DA Form 2408-14 (Uncorrected Fault Record), go on DA Form 2404. Nontactical equipment may not have a PMCS. Use a local checklist as a PMCS for that equipment. **BEFORE:** Operational checks and services are performed before the equipment leaves the maintenance facility or other dispatch point. **DURING:** Operational checks are performed while the equipment is being operated. **AFTER:** Operational checks and services are performed when the equipment completes the mission or returns to the maintenance facility or dispatch point.

(4) The operator and/or mechanic fix any new faults, if possible. The commander or the commanders representative decides if any remaining faults go on DA Form 2408-14 or keep the equipment from being dispatched.

(5) If the equipment is ready to dispatch, the dispatcher makes needed entries on DA Form 2401 and validates DD Form 1970 with signature and date.

(6) The operator leaves with the equipment and equipment record folder with all needed forms. During-operation checks are noted during equipment operation.

(7) When the mission is completed, the operator performs the after-operation PMCS on the equipment and annotates new faults on DA Form 2404. The operator and mechanic fix any faults they can and secure the equipment.

(8) The operator turns in the equipment record folder and all forms to the dispatcher. The dispatcher checks the forms for any open faults or needed actions. If DD Form 1970 has been completely filled, the dispatcher transfers needed information to a new DD Form 1970. The dispatcher then closes out DA Form 2401 entry for that item.

(9) Motor transport units performing line-haul operations transfer their semitrailers to a larger organization designated by the senior motor transportation command (either group or brigade). The commander of the larger transport organization establishes a semitrailer control office responsible for maintaining dispatch and maintenance records on those semitrailers.

### **2-4. Maintenance operation processes**

Operational records and system-generated reports provide the information needed to plan, manage, and control equipment. The operational processes menu contains the following functions:

a. *Equipment dispatch and return, DA Form 5987-E/DA Form 5987-I-E.* This process provides for the regular dispatch of equipment and return as shown below:

(1) *Equipment dispatch and return.* DA Form 5987-E allows the user to dispatch equipment with the option to produce a Motor Equipment Dispatch. This replaces the requirement for a DD Form 1970.

(2) *Equipment dispatch—returning.* This process is used when returning equipment from regular dispatch. It updates the end item, component usage, operator record, fuel usage, and dispatch control files.

(3) *Alert dispatch, DA Form 5987-1-E.* This provides dispatches, by Department of Defense activity address code (DODAAC), for all equipment listed in the equipment data file as alert dispatchable.

(4) *Print of equipment control log.* Provides a printout of the control log showing present and past dispatches for the month or until purged (first working day of the month).

*b. DA Form 5988-E.* This form allows the user to print an equipment maintenance and inspection worksheet for each piece of equipment by DODAAC, administrative number, or Federal Supply Catalog (FSC) to facilitate PMCS and other scheduled inspections. The FSC option allows the user to select an item on file by FSC; for example to select only generators, enter 6115. The system checks the document control register and maintenance fault file and prints all faults and parts that have been ordered (see para 3-10)

*c. Maintenance faults.* This update provides the capability to identify maintenance faults related to a specific piece of equipment to add, correct, update, or view these faults as required. Faults added are written to the appropriate maintenance files and appear on the equipment maintenance/inspection worksheets. Closed faults are purged at the completion of the Army Material Status System (AMSS) End of Report Period process.

*d. Parts installed.* This process enables the user to install parts that have been received either by administrative number or document number. Additionally, it updates the document control register.

*e. Services performed.* This process enables the user to enter data on services and tests performed on the equipment. The process updates the service due file, the equipment data file (EDF), and component data file. When services are performed, the system automatically schedules the next service due. However, the user must calculate and enter the next special service, lube, and AOAP due date. These service types and dates are written to the dispatch printouts and listed under service due data. Army policy also authorizes a 10 percent variance when performing services. The following procedures are followed when using ULLS-G:

(1) A service may not always be pulled when scheduled, so a 10 percent variance before or a 10 percent variance after the schedule of days, miles, or hours, is allowed. If the action is within the variance, the service is treated as if it was done on the day/miles/hours schedule.

(2) Some services may be too critical to have a variance. The equipment maintenance manual states if no variance is allowed.

(3) When the service is done within the variance, the equipment's miles, kilometers, or hours are recorded on the date service was scheduled. When a service outside the variance is completed, data is recorded on the actual day the service was completed. The computer schedules the next service from the new date.

(4) When the service exceeds the 10 percent variance, the equipment is administratively designated NMC until the service is completed.

## **2-5. Equipment data updates**

This process allows the user to update equipment, operator, and administrative number data. The Equipment Data Updates menu contains the following functions:

*a. Equipment add.* Enables the user to add equipment to the equipment data file. AMSS reportable items must be loaded individually. Commanders can determine if weapons, protective masks, kitchen equipment, and so on are to be loaded separately or grouped as like items. Serial numbered equipment (equipment tracked by serial number on property printout) should be loaded individually. Nonreportable items (machine guns) that deadline weapons systems must be loaded as subsystems.

*b. Equipment data file update.* Provides the capability to update catalog and administrative number data. It also allows users to change admin numbers.

*c. Component file update.* Allows the user to add, change, or delete AOAP component data. If the engine or transmission was changed, use change component serial number option. If the engine/transmission has never been on file, use component add. If the engine/transmission was added by mistake, use component delete.

*d. Equipment service update.* Allows the user to add or update scheduled services or special services.

*e. Equipment delete (Items without an equipment readiness code (ERC)/serial # only).* This process deletes a piece of equipment by administrative number. A report is automatically generated with administrative number data for the equipment just deleted.

*f. Equipment transfer.* This process allows the user to accept or pass on a serial numbered piece of equipment, via diskette or telecommunications.

## **2-6. Equipment data reports**

The following functions provide hard copy reports:

*a. Equipment availability.* Provides the user with an Equipment Availability Report (fig 2-2), which displays the administrative number, model, and noun of dispatchable equipment, and if the equipment is available or unavailable for dispatch.

*b. Equipment fuel usage.* Provides a monthly, quarterly, or fiscal year fuel usage report for specific fuel types.

*c. Not mission capable.* The Deadline Report displays/prints all equipment by DODAAC that is NMC (fig 2-3).

*d. Equipment data file.* Allows the user to print major end items, components, and weapon without serial number or by administrative number with components.

## **2-7. Operator records/equipment class codes**

*a. Add operator.* This provides the user a means of adding operator records. When an operator qualification record is created, the system utilizes the data entries to dispatch vehicles to qualified operators. The system automatically calculates the operator's miles driven upon return of a dispatch and maintains the operators qualifications, restrictions, accidents, awards, and training until the record is deleted.

*b. Delete operator.* This must be used if an invalid license number was input and requires changes, or if an operator transfers from the unit.

*c. Change operator data.* This provides the means of updating an operators height, weight, miles driven, and so on, once the record has been added to the system. The user cannot change a driver license number. If an error is made, the user must delete the record and re-enter.

*d. Add/change qualifications.* This process allows the user to add or change Qualifications (Class Codes) to the Equipment Operator Qualification Record (fig 2-4).

*e. Delete qualifications.* This process allows the user to delete qualifications from Operator Qualification Record.

*f. Add class code.* This provides the capability for the user-created class codes (UA-UZ or ZA-ZZ) to be added to the class code file.

*g. Change description.* This allows the user to change class code description on codes from UA-UZ or ZA-ZZ.

*h. Delete class code.* This allows the user to delete class codes from UA-UZ or ZA-ZZ.

*i. Print class code.* This allows the user to print the class codes.

*j. Print operator record.* This allows the user to print a record.

*k. Print operator for specific code.* This allows the user to print a list of all operators for a selected DODAAC that have the selected code on their license.

*l. Print operator ID card.* This prints DA Form 5984-E (fig 2-5).

## **2-8. Equipment record folder**

*a.* The equipment record folder (NSN 7510-01-065-0166) holds the forms needed to keep up with equipment use, operation, and condition while on dispatch.

*b.* The equipment record folder is used each time an item of equipment goes on dispatch as shown below:

(1) The folder contains only the forms and records needed during a dispatch. For routine dispatch, a vehicle folder contains the current DA Form 5988-E or DA Form 2404 and DA Form 2408-14 when there is something deferred or on order for the equipment; DA Form 5987-E/DD Form 1970; and the accident forms, SF 91 and DD Form 518.

(2) DA Form 2408-4 (Weapon Record Data) goes in the folder only when the weapon is to be fired, serviced, or repaired.

(3) All the forms, except DD Form 314 and DA Form 2408-9, should be put in the folder when the equipment goes to support maintenance.

*c.* An equipment record folder is assigned to a specific item of equipment. DA Form 5823 (fig 2-6) in the front outside pocket ties the folder to the equipment.

*d.* The equipment record folder and all forms on an item of equipment go with the equipment when it is turned in or transferred.

## **2-9. DA Form 5823**

*a.* DA Form 5823 is not required if the unit is automated with ULLS. Its information is contained on DA Form 5987-E.

*b.* DA Form 5823 ties a particular equipment record folder to an item of equipment.

*c.* DA Form 5823 goes in the outside front pocket of each equipment record folder. Information on the card is used to identify the equipment covered, keep track of services due, and identify the assigned operator and leader.

*d.* The dispatcher and operator use the card to keep up with services and make sure the right folder is issued.

*e.* Keep information on DA Form 5823 current. Use DD Form 314 to update the information after each scheduled service.

*f.* DA Form 5823 is replaced when it is no longer readable.

## **2-10. DA Form 5987-E/DA Form 5987-1-E**

*a. Regular and alert dispatches.* DA Form 5987-E (fig 2-7) is a record of motor equipment use. It is required for all equipment being dispatched and to record equipment operating time.

(1) DA Form 5987-E is used to control the use of special purpose, combat, tactical, and nontactical vehicles and equipment, including material handling equipment.

(2) DA Form 5987-E is also used to record operating time on equipment that requires services. This includes such

equipment as generators, air compressors, centrifugal pumps, and so on. Operating time is the period of operation or hours of usage, using the time of day. Operating time is maintained throughout the dispatch cycle within ULLS.

(3) Equipment going to support maintenance is dispatched to and from support maintenance. An exception to this is when the unit requesting support maintenance and the support maintenance activity are collocated so that the equipment does not leave the maintenance facility area or area where equipment is maintained or stored. In this case, only a DA Form 5990-E (Maintenance Request) or DA Form 2407 (Maintenance Request) needs to accompany the equipment. At support maintenance, the maintenance request is used as a dispatch record for maintenance repair operations and final road testing.

(4) DA Form 5987-E is used to dispatch equipment that requires exercising because of low use or equipment in administrative storage.

(5) The option Alert Dispatch dispatches all equipment that is coded as alert dispatchable and produces DA Form 5987-1-E (fig 2-8). These dispatches are produced in advance. Alert dispatches are printed and kept on file until needed. Once used, a new set is printed and kept on file. The unit must have an Alert Dispatch on file at all times.

(6) Units may use a single DD Form 1970 as a continuation sheet to allow more than one subsequent operator when operational conditions do not support frequent redispersing using ULLS. Units produce a new DA Form 5987-E at the earliest opportunity. When commanders authorize the use of a DD Form 1970 as a continuation sheet, they ensure that subsequent operators are properly licensed.

#### *b. Disposition.*

(1) On the basis of entries recorded in the Return Usage portion of DA Form 5987-E, the dispatcher updates equipment/unit data (fuel added, date and time in, and any remarks). The usage data (current or estimated miles/kilometers/hours taken from the odometer or hour meter when the equipment return from dispatch, and oil added during dispatch) is also updated. This form is discarded when no longer needed.

(2) The dispatcher looks for any unusual entries in the Remarks block that may need further action.

(3) When equipment is involved in an accident or other situation under investigation, the dispatcher produces the Dispatch Control Log. The dispatcher attaches DA Form 5987-E for equipment to the log and maintains the forms until released by the investigator or at the completion of the investigation.

## **2-11. DD Form 1970**

DD Form 1970 is a record of equipment use.

#### *a. Use.*

(1) DD Form 1970 is used to control the use of special purpose and material handling equipment, combat, tactical, and nontactical vehicles.

(2) DD Form 1970 is used to record operating time on equipment that requires services based on hours only. This includes such equipment as generators, air compressors, centrifugal pumps, and so forth. Operating time is the time of operation, using the time of day or hours of usage. Equipment on which an operating time DD Form 1970 is kept only requires an entry on DA Form 2401 when the equipment is used for the purpose for which it was intended; that is, a generator used to provide electrical power or a compressor used to provide compressed air for a mission or mission support. An entry on DA Form 2401 is not normally required when equipment is not leaving the maintenance facility area or area where equipment is maintained or stored. An entry is made on DA Form 2401 for equipment that is routinely used within the maintenance facility area for its intended purpose, for example, a compressor that is routinely used to provide air in maintenance operations or a generator that routinely provides power to a shelter where work or training is conducted.

(3) DD Form 1970 is used for the following varying periods depending on its use:

(a) For regular dispatches, DD Form 1970 (fig 2-9) is used until all the spaces in either the operator or action section have been filled. For equipment with a single operator, for example, DD Form 1970 is normally used for four separate dispatches before it is discarded.

(b) For an extended dispatch, DD Form 1970 (fig 2-10) is used until all the spaces in either the operator or destination sections have been filled. An extended dispatch is used whenever the equipment being dispatched will not return to the maintenance facility within the dispatch day for example, prior to 2400. Examples for use of extended dispatch include guard duty and maneuvers. When an extended dispatch may require more room than one DD Form 1970 allows, the dispatcher provides blank copies of DD Form 1970 to use as continuation sheets.

(c) Forms recording only operating time are used until the destination or operator section is filled in (fig 2-11).

(4) DD Form 1970 is used for control purposes for administrative, engineering, and housing maintenance facilities that do not have automated data processing (ADP) support. Each dispatch requires a separate DD Form 1970.

(5) Equipment going to support maintenance is dispatched to and from support maintenance on DD Form 1970 and DA Form 2401. An exception to this is when the unit requesting support maintenance and the support maintenance activity are located so that the equipment cannot leave the maintenance facility area where equipment is maintained and stored. In this case, only a DA Form 2407 needs to accompany the equipment. At support maintenance, DA Form 2407 is used as a dispatch record for maintenance repair operations and final road testing.

(6) DD Form 1970 is used to record exercises of low-usage equipment and equipment in administrative storage.

(7) DD Form 1970 may be used as a continuation sheet for a DA Form 5987-E when authorized by the commander. Only one DD Form 1970 may be used per DA Form 5987-E.

*b. Disposition.*

(1) The dispatcher—

(a) Puts the time of return on DA Form 2401.

(b) Transcribes needed information to a new DD Form 1970. For equipment under the AOAP, the dispatcher uses the quantity of oil added from the Remarks block. This number is added to the total in the Oil block at the top of the completed DD Form 1970. The new total is entered in the Oil block of the new DD Form 1970. The dispatcher keeps a total of oil added to the item only until the next oil sample is taken. The date and hour of the next oil sample are found on DA Form 5823 and DD Form 314. When an oil sample is taken, the figure in the Oil block of DD Form 1970 goes to zero. This information is needed for DD Form 2026 (Oil Analysis Request) that is sent in with each oil sample.

(c) Adds the fuel added during dispatches to the total in the Fuel block, when required locally. The new total is placed in the Fuel block on the new DD Form 1970. Local standard operating procedures (SOPs) determine how long and when fuel totals are kept.

(d) Looks for any unusual entries in the Remarks block that need further action.

(e) Keeps the last completed DD Form 1970 until a new form is completed, after needed information has been moved to other forms. No more than two DD Forms 1970 may be kept on the equipment: one completed copy on file and one open for dispatch.

(f) Keeps DD Form 1970 on the equipment until released by the investigator, when equipment is involved in an accident or other situation under investigation. A new DD Form 1970 is prepared the next time the vehicle is dispatched.

(2) A completed DD Form 1970—

(a) When used to dispatch equipment, is considered completed whenever the operator blocks, time in and out blocks, or destination blocks are filled. The commander may line out unused portion to close out a form whenever needed.

(b) When used to show running time on equipment is considered completed when the destination or operator blocks are filled.

## **2-12. DA Form 5982-E/DA Form 2401**

DA Form 5982-E and DA Form 2401 are records of operators and location of equipment on dispatch or in use.

*a. Use.*

(1) Units using ULLS are not required to use a DA Form 2401. ULLS generates a DA Form 5982-E for all equipment dispatched (fig 2-12).

(2) DA Form 2401 is used under manual procedures.

(3) The form documents equipment use. It also lets the commander know where the equipment is and when it should return.

*b. General information on DA Form 2401.*

(1) DA Form 2401 (fig 2-13) may be overprinted when the same equipment is dispatched every day.

(2) A separate DA Form 2401 is used to show the dispatch of radio taxis. When DA Form 2401 is used for radio cab dispatch, columns a through m are filled in as required locally.

(3) The same page may be used for more than one day. A line is drawn through the middle of columns a through e below the last dispatch entry for a day. The next date is written in column f (Destination), then a line is drawn through the middle of columns g through i. No line or date entry is made for days no equipment is dispatched.

(4) Separate line entries are used for equipment that is towed to a location but that will not return with the dispatched equipment.

(5) Equipment for command maintenance periods or routine maintenance is not dispatched unless it leaves the equipment or maintenance facility area.

(6) Equipment sent to support maintenance on a DA Form 2407 is dispatched on DD Form 1970 and DA Form 2401, except as noted in paragraph 2-10a(3) and 2-11a(5).

*c. Disposition.*

(1) DA Form 5982-E/DA Form 2401 is destroyed after one month except in the case of an accident investigation after the last entry in column 1 has been closed out.

(2) If an accident or unusual situation occurs, DA Form 2401 is kept until the investigator releases it.



NAME (Last, first, initial) AND SERVICE NUMBER Jones, John L. 111-41-7119					PERMIT (Initial)	
					NUMBER J-7119	DATE ISSUED 10 JUN 93
					TYPE ARMY STANDARD	LIMITATIONS (Physical or operational) R 1
SEX M	DATE OF BIRTH 1 May 64	COLOR HAIR Brown	COLOR EYES Green	HEIGHT 5' 9"	WEIGHT 160	POSITION TITLE (If civilian)
<b>SECTION I - OFFICIAL QUALIFICATIONS</b>						
TYPE OF EQUIPMENT	SIZE	SPECIAL QUALIFICATION <sup>1</sup>	DATE QUALIFIED	QUALIFIED AT	NAME OF EXAMINER	
HEMTT, M977	10 TON	SE	10 JUN 93	FR EUSTIS, VA	Guy F. Smith	
<b>SECTION II - BACKGROUND AND EXPERIENCE</b>						
TYPE OF EQUIPMENT	SIZE	TYPE OF DRIVING OR OPERATION <sup>2</sup>	ADDITIONAL DRIVER'S LICENSES (State or agency)	NUMBER OF OTHER DRIVER'S LICENSES	SATISFACTORY EXPERIENCE VERIFIED BY	
SEDAN	5 PASS	CITY/RURAL	VA	31 MAY 99 T-4143-2143	Guy F. Smith	
<sup>1</sup> Special equipment, special operations or conditions <sup>2</sup> City, rural, long haul, etc.						
<b>SECTION III - PERFORMANCE RECORD</b>						
(List chronologically as "credits" - awards, training, retraining, testing, retesting, roadtests, permit renewal, relicensing, etc; and as "debits" - accidents, arrests, violations, warnings, revocations, suspensions, etc.)						
DATE	CREDITS	DEBITS	TYPE OR NATURE	ACTION TAKEN		
4 JUN 93	40 HRS		QUALIFICATION	COMPLETED DRIVER TNG		
				IAW AR 600-55, <del>REG</del> ROBERT E. COOK		
10 JUN 93	2 HRS		TESTING / LICENSING	ARMY STANDARD Guy F. Smith IAW 600-55, GUY F. SMITH		
10 JUN 93	1 HR		ACCIDENT AVOIDANCE	IAW 600-55, SAM WILSON <del>STL</del>		
12 OCT 93	1 HR		WINTER DRIVER TNG	IAW TCFE REG 21-305, GARY FLY <del>STL</del>		
<b>EQUIPMENT OPERATOR'S QUALIFICATION RECORD (EXCEPT AIRCRAFT)</b> (AR 600-55 and AR 385-55)						

DA FORM 348, OCT 64

REPLACES DA FORM 348, 1 AUG 60, WHICH WILL BE USED, AND DD FORM 1360 WHICH IS OBSOLETE FOR ARMY USE.

(Extract from personnel file to maintain at operating level.)

USAPA V1.02

Figure 2-1. Sample DA Form 348 (front)

SECTION IV - EXAMINATION FINDINGS					
<b>BATTERY I -</b> (Administered as a part of reception processing, at reception stations)		<b>BATTERY II -</b> (To be administered to all applicants for Driver Permit SF 46) (To transfer raw score to standard score see DA Pamphlet 611-119)			
		DA FORM 6122	RAW SCORE	STANDARD SCORE	
ENTER SCORE FROM ITEM 24 OF INDIVIDUAL'S DA FORM 20		DA FORM 6123			
		DA FORM 6124			
		<b>TOTAL STANDARD SCORE</b>			
		STANDARD SCORE FOR BATTERY II (Divide Total Standard Score by 3)			
STANDARD SCORE		SUCCESSFUL COMPLETION <input type="checkbox"/> YES <input type="checkbox"/> NO		EXAMINATION ADMINISTERED BY (Last name - first name - middle initial)	
<b>I PHYSICAL EVALUATION MEASURES</b>		✓ - IF QUALIFIED X - IF SUBSTANDARD.		SIGNATURE OF EXAMINER	
1. VISUAL ACUITY		LEFT EYE 20/20	RIGHT EYE 20/20	✓	Guy F. Smith
2. FIELD OF VISION		LEFT EYE 98°	RIGHT EYE 98°	✓	Guy F. Smith
3. HEARING		LEFT EAR NA /20	RIGHT EAR NA /20	✓	Guy F. Smith
4. REACTION TIME		30/100 SEC	35/100 SEC	✓	Guy F. Smith
5. DEPTH PERCEPTION		normal		✓	Guy F. Smith
6. COLOR PERCEPTION		normal		✓	Guy F. Smith
SIGNATURE OF MEDICAL AUTHORITY					
<b>II DRIVING PERFORMANCE TEST</b> (Check "✓" if successful, "x" if failed and corrective training is needed)					
<b>A. ROAD TEST - PREREQUISITE</b>					
1. INSTRUMENTS (Location, correct reading, action for abnormal reading)		✓ OIL LEVEL STICK	✓ TEMPERATURE GAGE	✓ OIL PRESSURE GAGE	✓ VOLTOMETER
		✓ AMMETER	✓ TACHOMETER	✓ FUEL GAGE	✓ AIR PRESSURE GAGE
2. BEFORE OPERATION CHECK		✓ VEHICLE DAMAGE	✓ CONDITION OF TIRES	✓ CLEAN HEADLIGHTS	✓ OIL LEVEL
		✓ MIRROR ADJUSTMT.	✓ HORN	NA HAND BRAKES	✓ BATTERY
				✓ FOOT BRAKES	✓ WATER LEVEL
3. EMERGENCY EQUIPMENT (Location and use)		FIRE EXTINGUISHER ✓	HIGHWAY WARNING KIT ✓	OTHER (Describe) N/A	
4. CONTROLS - "DRY RUN"		GEARS N/A	BRAKE ✓	CLUTCH N/A	FRONT AXLE ✓
5. DEPTH PERCEPTION (Two feet from target)		FIRST TRY ✓	SECOND TRY N/A	THIRD TRY N/A	
6. PRACTICE RUN (1/2 mile)		START ✓	PULL OUT ✓	SHIFT ✓	3 STOPS ✓
				✓ TURNS	✓ BACKING
7. ADDITIONAL REQUIREMENTS FOR LICENSE		✓ LOCAL LAWS	✓ OPERATING PROCEDURES	✓ ACCIDENT REPORTING	
		OTHER (Describe)			
<b>B. ROAD TEST - SCORED PHASE (DA PRT 2678)</b>					100
COMMENTS AND RECOMMENDATIONS OF ROAD TEST EXAMINER				NUMBER OF TALLY MARKS ON CHECK LIST PRT 2678 (Subtract)	10
				ROAD TEST SCORE	90
				SIGNATURE OF ROAD TEST EXAMINER Guy F. Smith	
MY DRIVING WEAKNESSES HAVE BEEN MADE KNOWN TO ME AND I HAVE BEEN SHOWN HOW TO OVERCOME OR ADJUST THEM.		DATE 10 JUN 93	SIGNATURE OF APPLICANT John L. Jones		

REVERSE, DA FORM 348, OCT 64

USAPA V1.012

Legend for Figure 2-1; completion instructions follow.

NAME (Last, first, initial) AND SERVICE NUMBER. Enter last name, first name, middle initial, and social security number (SSN).

Figure 2-1. Sample DA Form 348

## PERMIT

NUMBER (*Initial*). Enter the permit number. Permit numbers are the first letter of the last name and last four number of the individual's SSN, (for example, K-1234). Upon completion of local training requirements and appropriate entries in section III, update the ULLS-G.

DATE ISSUED. Enter day, month, and year permit or license is effective. The license expires according to chapter 6 of AR 600-55.

TYPE. (Pencil Entry/Entries). Enter the type DA Form 5984-E permit (that is, standard, limited, and so forth).

LIMITATIONS (Pencil Entry): Enter one or more of the following codes: Code Application: R1 Corrective lenses required. R2 Daylight only. R3 Automatic transmission only. R4 Not authorized to drive a vehicle equipped with air brakes. R5 Driving on the installation only.

SEX. Enter 'M' for male or 'F' for female.

DATE OF BIRTH. Enter the day, month, and year of the individual's birth, obtained from individual's DD Form 2A (Identification Card).

COLOR HAIR. Enter the individual's hair color—brown, black, blond, and so forth.

COLOR EYES. Enter the color of eyes – blue, brown, hazel, and so forth.

HEIGHT. Enter the feet and inches (5'10") the height of the individual as stated on his or her DD Form 2A.

WEIGHT. Enter in pounds the weight of the individual as stated on his or her DD Form 2A.

POSITION TITLE (*if civilian*). Not used by military personnel. For civilian personnel, enter appropriate job title.

### SECTION I—OFFICIAL QUALIFICATION.

TYPE. Enter description or model of equipment (for example: HEMTT, M977). If qualified to tow a trailer (either kingpin or pintle connected), indicate "w/trailer" (for example, tractor, M931 w/trailer).

SIZE. Enter in tonnage or passenger capacity (for example, 10-Ton, 40-Pass).

SPECIAL QUALIFICATION. Enter one or more of the following codes: S1 Trailers, pintle towed. S2 Trailers, kingpin/pintle. S3 Winch qualified (front). S4 Wrecker qualified. S5 Cable operated cranes. S6 Emergency vehicle. S7 Winter/wet/cold weather training.

DATE QUALIFIED. Enter the day, month, and year individual was qualified to operate equipment entered in block 13 (for example, 07 JUL 89).

QUALIFIED AT. Enter activity unit identification code, post, camp, or station where qualification to operate equipment took place.

NAME OF EXAMINER. Enter qualifying official's (examiner's) name. Qualifying official signs in black ink upon verification of individual's ability to operate equipment.

### SECTION II—BACKGROUND AND EXPERIENCE

TYPE OF EQUIPMENT. Enter as appropriate the item the individual was qualified to operate; that is, sedan, motorcycle, and so forth.

SIZE. Enter as appropriate vehicle size; that is 5-ton, 5-pass, and so forth.

TYPE OF DRIVING OR OPERATION. Enter as appropriate; that is, highway, city, rural, and so forth.

ADDITIONAL DRIVER'S LICENSES (*State or agency*). Enter the State or agency that issued license; for example, VA, PA, U.S. Army, and so forth.

NUMBER OF OTHER DRIVER'S LICENSES. Enter the license serial number and expiration date; for example, 000-11-0000/07 JUL 94.

SATISFACTORY EXPERIENCE VERIFIED BY. Enter the name of the individual who verified the licensee's experience.

### SECTION III—PERFORMANCE RECORD

DATE. Enter the day, month, and year the individual completed formal training on the equipment he or she is authorized to operate. In cases where road tests, age, or local requirements such as assistant drivers, are necessary, training may be completed before the individual is actually qualified in section I of DA Form 348. Dates of accidents, awards, and traffic violations are also to be noted here.

CREDITS. For example, "training," "orientation," "rodeo," "retesting," "relicensing."

DEBITS. For example, "remedial training," "refresher course," or other training required because of accidents, traffic violations, or unsafe acts while operating military and civilian equipment.

TYPE OR NATURE. Enter a word or phrase that best describes the type or nature; for example, type of license issued (standard, learner, incidental, limited), type of training (that is, orientation, qualification, sustainment), renewal, retest, safety award, type of accident or traffic violation (that is, driving under the influence, speeding, backing and so forth).

ACTION TAKEN. Enter any actions taken by the commander to ensure that each individual maintains a high standard as a vehicle or equipment operator. A commander or supervisor can glance at this section for information about an individual's driving or operating performance. Cite the DA or local regulation which directed that training be conducted, or the regulation under which a safety award was issued. Note actions taken for accidents or moving traffic violations regardless of whether they occurred while driving a military or privately owned vehicle (to include annotation of license suspension or revocation). Accidents in which the driver was not at fault are not entered. Enter the printed name of the person making the entry and have him or her initial over his or her name.

### SECTION IV—EXAMINATION FINDINGS. Leave this section blank.

#### I PHYSICAL EVALUATION MEASURES

1. VISUAL ACUITY. Enter the visual acuity of the left and right eyes in the applicable blocks. The minimum standard is correctable 20/40 in the better eye.

2. FIELD OF VISION. To be filled in by qualified licensing personnel.

3. HEARING. To be filled in by qualified licensing personnel.

4. REACTION TIME. To be filled in by qualified licensing personnel.

5. DEPTH PERCEPTION. To be filled in by qualified licensing personnel.

6. COLOR PERCEPTION. To be filled in by qualified licensing personnel.

✓ – IF QUALIFIED, X – IF SUBSTANDARD.

Figure 2-1. Sample DA Form 348

SIGNATURE OF EXAMINER. Self-explanatory.

COMMENTS AND RECOMMENDATIONS ON SUBSTANDARD ITEMS. Driver candidates determined to be physically substandard (blocks 38 through 41) or abnormal (blocks 42 and 43) are referred to appropriate medical authority to determine whether they should be qualified for driving. Medical personnel enter comments or recommendations. For example, visual acuity corrected to 20/20 with glasses.

SIGNATURE OF MEDICAL AUTHORITY. This block is used only when the driver candidate has been referred to a medical authority, at which time a qualified medical officer signs it.

II DRIVING PERFORMANCE TEST (Check "✓" if successful, "x" if failed and corrective training is needed).

A. ROAD TEST—PREREQUISITE. Enter a checkmark in the applicable blocks to indicate successful completion of each task. Enter an "x" in the applicable block when the individual has failed and corrective training is needed. Enter "NA" (not applicable) when any portion of the test does not apply to the vehicle or equipment on which the individual is not being tested.

OTHER. Enter successful or unsuccessful completion of DA Form 2404. Additional requirements for licensing required by local commander may also be entered here.

B. ROAD TEST—SCORED PHASE (DA PRT 2678)

NUMBER OF TALLY MARKS ON CHECK LIST PRT 2678 (Subtract). Enter the number of errors from the checklist recorded during the road test. Errors indicate requirements for additional training.

ROAD TEST SCORE. Subtract the number of errors in block 50 from 100 to get the road test score. This score is shown as a percent. A score of 75 percent or higher is passing. Enter this score.

COMMENTS AND RECOMMENDATIONS OF ROAD TEST EXAMINER. Enter any strong points or weaknesses the examiner may have pointed out to the applicant. Enter "NONE" if appropriate.

SIGNATURE OF ROAD TEST EXAMINER. Enter in ink the payroll signature of the individual that administered the actual road test. The examiner must meet the qualification requirements in this regulation.

DATE. Enter the day, month, year.

SIGNATURE OF APPLICANT. Have the applicant sign his or her payroll signature.

Figure 2-1. Sample DA Form 348

---

DATE: 20031204	EQUIPMENT AVAILABILITY	AWCMF417	
DODAAC: W33VT3	A CO 3RD BN 7TH INF		
ADMIN NUM	MODEL	NOUN	STATUS
A11	M2A2WODS	INFANTRY FIGHTING VEH	AVAILABLE
A12	M2A2WODS	INFANTRY FIGHTING VEH	AVAILABLE
A13	M2A2WODS	INFANTRY FIGHTING VEH	AVAILABLE
A14	M2A2WODS	INFANTRY FIGHTING VEH	AVAILABLE
A21	M2A2WODS	INFANTRY FIGHTING VEH	AVAILABLE
A22	M2A2WODS	INFANTRY FIGHTING VEH	AVAILABLE
A23	M2A2WODS	INFANTRY FIGHTING VEH	AVAILABLE
A31	M2A2WODS	INFANTRY FIGHTING VEH	AVAILABLE
A32	M2A2WODS	INFANTRY FIGHTING VEH	AVAILABLE
A33	M2A2WODS	INFANTRY FIGHTING VEH	AVAILABLE
A3W	M149A2	TRLR TANK WATER	AVAILABLE
A4T	M105A2	TRLR CGO 1.5T	AVAILABLE
A65	M2A2WODS	INFANTRY FIGHTING VEH	AVAILABLE
A66	M2A2WODS	INFANTRY FIGHTING VEH	AVAILABLE
ATM	MEP831	GEN SET DSL SM	AVAILABLE
HQ801	M113A3	CARRIER PERSONNEL	AVAILABLE
HQ911	M113A3	CARRIER PERSONNEL	AVAILABLE
HQ921	M88A1	REC VEH FT MED AR	AVAILABLE
HQ931	M1078	TRK CGO LMTV	AVAILABLE
HQ931T	M105A2	TRLR CGO 1.5T	AVAILABLE
HQ941T	M105A2	TRLR CGO 1.5T	AVAILABLE

---

Notes:

<sup>1</sup> Dispose of this form when no longer needed.

Legend for Figure 2-2;

completion instructions follow. This report is produced by DODAAC and Unit.

DATE. Displays the date of the report.

Figure 2-2. Sample ULLS-generated AWCMF417 (Equipment Availability Report)



ADMIN NUMBER. Self-explanatory.  
SERIAL NUMBER. Serial number of item or piece of equipment.  
MODEL. Self-explanatory.  
LIN. Line item number of the item or piece of equipment.  
ORG WON (work order number). The ULLS-generated organizational work order number.  
DOCUMENT NUMBER. The document number that identifies the part ordered. This defaults to a fault sequence number when the parts are received.  
NAR DATE. This displays the not available reason code (NAR) (see the ULLS electronic user's manual for a list of these codes) and the date of this code.  
NIIN/PART NUMBER. National item identification number or part number.  
ORIG DATE NMC. Shows the date the item was originally NMC.  
QTY DUE. Quantity of items due in.  
ORG DATE. Date the equipment was NMC at the unit.  
QTY REC. Quantity of items received.  
DSU DATE. Date equipment was down for support level maintenance.  
STAT/DATE. Displays the status and date for a shipment.  
REMARKS. Brief description of part or reason for deadline.  
SHIP DATE. Shows the shipping date, if available.  
SUP WON. Displays the machine generated support work order number.  
FAULT DESCRIPTION. Identifies reason item is NMC.  
FAULT OPENED. Reflects the date and time the fault was entered.  
FAULT CLOSED. Reflects the date and time the fault was closed out.

**Figure 2–3. Sample ULLS-generated AWCMF458 (Non-Mission Capable Report)**

---

HQ 3D BN 7TH IN

DODAAC: W33VT7

CODE	DESCRIPTION
A1	COMM VEH BELOW 10,000 #
A2	COMM VEH OVER 10,000 #
B1	BUSES LESS THAN 25 PASS
B2	BUS 25 PASS AND BELOW
B3	BUS 48 PASS AND BELOW
B4	BUS 90 PASS AND BELOW
C1	CRANE 5 TON
C2	CRANE 7 1/2 TON
C3	CRANE 12 1/2 TON
C4	CRANE 20 TON
C5	CRANE 25 TON
C6	CRANE 40 TON
C7	CRANE 65 TON
C8	CRANE 140 TON
C9	CRANE 250 TON
D1	BULLDOZER, ALL MODELS
D2	SCRAPERS, ALL MODELS
D3	GRADERS, ALL MODELS
D4	BACKHOE, ALL MODELS
D5	SCOOPLOADER, ALL MODELS
D6	ROLLER, ALL MODELS
DM	ENGINEER EQUIP ALL
E1	GENR 10 KW AND BELOW
E2	GENR 60 KW AND BELOW
E3	GENR 200 KW AND BELOW
E4	POWER STATION OVER 200 KW
F1	TRACTOR WAREHOUSE
G1	COMPRESSOR 175PSI & BELOW
G2	COMPRESSOR 750PSI & BELOW
G3	COMPRESSOR OVER 750 PSI
H1	FORKLIFT 6000 LB & BELOW
H2	F/L RT 10000 LB & BELOW
H3	F/L RT 50000 LB CONT HAND
I1	FORKLIFT ELECTRIC, ALL
LI	LICENSE ISSUED
P1	PUMP 225 GPM & UNDER
P2	PUMP OVER 225 GPM
QA	AWARD WHL VEH DRIVER
QB	AWARD TRACKED VEH DRIVER
QC	AWARD DRIVER - M

Legend for Figure 2-4;

completion instructions follow. This report is generated as required. Dispose of this listing when no longer needed. This listing is produced by unit and DODAAC.

CODE. The equipment class code as recorded within ULLS. This code is used in the dispatch process to check if the operator is qualified to operate a specific piece of equipment.

DESCRIPTION. The narrative description of the Equip Class Code as recorded within ULLS.

**Figure 2-4. Sample ULLS-generated DA Form 5985-E (Class Codes)**

OPERATOR'S PERMIT DA FORM 5984-E

U.S. ARMY MOTOR VEHICLE OPERATOR'S IDENTIFICATION CARD

Name of Operator MI Sex Date Issued:  
 JOHN DOE N M 20030803 :  
 Height Weight Date of Birth SSN Date Expired:  
 5 9 179 19790420 0000-00-0000 20040403 :  
 Color of Hair Eyes :  
 BLK BRN :  
 Name/Loc Issue Unit :  
 HHC 3/7 IN CPT. S. SZYMANSKI :  
 09303 COMMANDER :  
 NOT TRANSFERABLE: CARD REQUIRED TO OPERATE GOVT VEHICLE:  
 PRIVACY ACT OF 1974 APPLIES :

QUALIFICATIONS/RESTRICTIONS

F/L RT 10000 LB & BELOW FORKLIFT ELECTRIC, ALL :  
 TRLR PINTLE TOWED ACCIDENT AVOIDANCE CLASS :  
 M998 TRK UTIL LMTV M1078 2 1/2 CARGO TK :  
 M1114 2 - 1/2 TON AND BELOW :  
 5 TON AND BELOW AOAP QUALIFIED :  
 PMCS QUALIFIED TNG/W PVS7A&D :  
 INCIDENTAL LISCENSE IRAQ :

Legend for Figure 2-5;  
 completion instructions follow.  
 Name of Operator. The operators last and first name.  
 MI. The operators middle initial.  
 Sex. M for male; F for female.  
 Date Issued. Self-explanatory.  
 Height. Self-explanatory.  
 Weight. Self-explanatory.  
 Date of Birth. Self-explanatory.  
 SSN. Operators Social Security number (SSN).  
 Date Expired. Date the license expires.  
 Color of Hair/Eyes. Self-explanatory.  
 SIGNATURE OF OPERATOR. The operator whose name appears signs here.  
 Name/Loc Issue Unit. The name and location of the issuing unit. In addition, this block contains the name and title of the issuing officer. The issuing officer signs above name. The information listed below the dotted line displays operators qualifications and/or restrictions.

Figure 2-5. Sample ULLS-generated DA Form 5984-E



1. BUMPER NO. <i>B401</i>	2. MODEL <i>M923</i>
3. NOUN <i>TRK CGO STON</i>	4. NSN <i>2320-01-050-2084</i>
5. SERIAL NO. <i>C523-01798</i>	6. AOAP SAMPLE <i>10APR97 / 1196</i>
7. NEXT SERVICE AT <i>10JUL97 / 18960</i>	8. NEXT LUBE AT <i>10APR97 / 15960</i>
9. OPERATOR <i>MOSZER PFC</i>	10. SUPERVISOR <i>STRANDE CW3</i>

DA FORM 5823, SEP 89

EQUIPMENT IDENTIFICATION CARD

\*U.S. G.P.O.: 1993 - 342-027/80493

For use of this form, see DA PAM 750-8;  
the proponent agency is DCS, G4

Notes:

<sup>1</sup> Operator and supervisor or leader names are used for two purposes. If the folder is lost or misplaced, the finder has names to track down. Most important, those names show who is responsible for the equipment, the forms in the folder, and the information on the equipments condition.

<sup>2</sup> The back of the card may be used for locally required information. For example, if the command asks for a monthly mileage report, enter the start and end dates and miles on the card in pencil. Miles traveled are shown on DD Form 1970.

Legend for Figure 2-6;

completion instructions follow.

1. BUMPER NO. Enter the bumper number of the end item or equipment.

2. MODEL. Enter the model number.

3. NOUN. Enter the noun or noun abbreviation.

4. NSN. List the end item NSN.

5. SERIAL NO. List the serial number for the equipment. For equipment managed by registration number, enter the item's registration number on the card.

6. AOAP SAMPLE. Enter the date and hours the next AOAP sample is due. Get this information from the equipments DD Form 314 or AOAP lab printout. When making this entry, only use pencil. This entry is only needed for equipment under AOAP.

7. NEXT SERVICE AT. Enter the date and/or miles, kilometers, or hours when the next scheduled service is due on the equipment. Get this information from DD Form 314. Pencil entry.

8. NEXT LUBE AT. Enter the date and/or miles, kilometers, or hours when the next scheduled lubrication service is due on the equipment. Pencil entry. Get this information from DD Form 314.

9. OPERATOR. The operator's last name and rank go here. Pencil entry. Leave blank if more than one operator is assigned to the equipment.

10. SUPERVISOR. Enter the last name and rank of the operators leader or supervisor here. Pencil entry.

Figure 2-6. Sample DA Form 5823

DATE: 20031205

MOTOR EQUIPMENT DISPATCH

DA FORM 5987-E

HQ 3D BN 7TH IN  
BLDG 1265  
FSGA, 31314  
PHONE NUMBER: (912)767-7776

UIC: WAQYT0

DATE DISPATCHED: 20031205

TIME DISPATCHED: 1144

----- EQUIPMENT DATA -----

ADMIN NUM: HQ6  
EQUIP MODEL: M1097A2  
EQUIP NOUN: TRK UTL HV  
EQUIP NSN: 2320013808604  
SERIAL NUM: 207335  
REGISTRATION NUM:  
EQUIP LICENSE NUM: NG53YA  
KEY NUM:

----- SERVICE DUE DATA -----

	TYPE	DATE	MI/KM/HR
TYPE PMCS DUE:	A	20041101	M 3000
NEXT OIL ANALYSIS DUE:		-----	0
NEXT LUBRICATION DUE:		-----	0
NEXT SPECIAL SERVICE DUE:		-----	0

----- DISPATCH INFORMATION -----

OFFICIAL USER NAME/PHONE NUM: LTC FUNK DAVID E. / -----

DESTINATION: FT STEWART, GA  
EXPECTED DATE/TIME OF RETURN: 20031205 COB OR 1730

EQUIP DISPATCHER'S SIGNATURE:   
SPC ROMERO VALENTIN

1ST OPERATOR'S SIGNATURE:   
RALSTON GARRETT

2ND OPERATOR'S SIGNATURE: \_\_\_\_\_

AUTHORIZATION: \_\_\_\_\_

RELEASED BY:  SFC

DISPATCH OUT REMARKS: RANGE GOLF

----- FUEL ITEM USAGE DATA -----

EQUIPMENT NOUN	M/H/K	CURRENT READING	READING AT RETURN	FUEL USAGE (IN GALLONS)
TRK UTL HV	M	000277	287	2

----- COMPONENT(S) USAGE DATA -----

SERIAL NUMBER	COMPONENT NOUN	M/H/K	CURRENT READING	READING AT RETURN	OIL ADDED (IN QUARTS)
1633B1286	TRANSMISSION	M	000277	287	0
41486	ENGINE	M	000277	287	0

Notes:

<sup>1</sup> This form replaces the requirements to use DD Form 1970.

<sup>2</sup> If there was more than one operator while the vehicle was dispatched, the dispatcher ensures that each operator's Qualification Record is updated appropriately.

Legend for Figure 2-7;

completion instructions follow. Unit address, telephone number, and UIC are retrieved automatically from the database; no entries required from the operator.

Figure 2-7. Sample ULLS-generated DA Form 5987-E

DATE DISPATCHED. The date equipment is dispatched. ULLS default entry.

TIME DISPATCHED. The military time equipment is dispatched. ULLS default entry.

EQUIPMENT DATA. Administrative number, equipment model number, equipment noun, equipment NSN, equipment serial number, registration number, equipment license number, and key number are retrieved automatically from equipment data file; no entries are required from the operator.

SERVICE DUE DATA. Information in this section is retrieved automatically from the ULLS database; no entries required from the operator. Operator/supervisor reviews this section and takes appropriate actions as required.

DISPATCH INFORMATION

OFFICIAL USER NAME/PHONE NUM. The operator requesting the dispatch provides the last name, first name, middle initial, rank/grade, and telephone number to the dispatcher. Dispatcher enters the name of the person to whom the operator is to report (official user). This person is responsible for the equipment when in use.

DESTINATION. The dispatcher enters into the ULLS system the location of dispatch area.

EXPECTED DATE/TIME OF RETURN. Dispatcher enters close of business or the actual time the user expects to return with the equipment. The operator ensures the dispatcher reviews the expected date/time of return. If equipment cannot be returned because of mission, operator notifies the official user who requests an extended dispatch.

EQUIP DISPATCHER'S SIGNATURE. The dispatcher signs his/her name.

1ST OPERATOR'S SIGNATURE. The operator signs his/her name. If operators are changed while the vehicle is dispatched, annotate the hours/miles/kilometers on the equipment to the right of the operator's signature.

2ND OPERATOR'S SIGNATURE. This line will be used if operators are changed while the equipment is on dispatch. This normally happens when an operator becomes sick or overly tired (for example, during convoy operations). The operator signs his/her name.

AUTHORIZATION. This block/area can be used for off post authorization. The commander or the commander's designated representative signs and enters rank for off post travel. For second or third operator authorization: When a situation occurs requiring a change of operators and there is no dispatcher present to verify a drivers qualifications, enter the name and rank of person authorizing the change or modification.

RELEASED BY. Official user will sign when equipment is returned and the mission is completed.

DISPATCH OUT REMARKS. The dispatcher enters all towed equipment by the prime mover. If equipment was extended the operator writes the words EXTENDED DISPATCH, the name and rank/grade of the person authorizing the extension, and expected date of return. The official user or the commander's designated representative signs and enters rank when operator is released or mission is completed.

END ITEM USAGE DATA. Equipment noun, miles/hours/kilometers and current reading are ULLS- generated entries.

EQUIPMENT NOUN. Displays the equipment noun.

M/H/K. This displays how equipment is tracked, by either miles/hours/kilometers.

CURRENT READING. Displays the reading of previous block, in miles/hours/kilometers, prior to dispatch.

READING AT RETURN. Operator enters this at time of return.

FUEL USAGE (IN GALLONS). The operator enters the amount of fuel in gallons added while the equipment was on dispatch.

COMPONENT(S) USAGE DATA. Components serial number, noun, miles/hours/kilometers, and current reading are ULLS-generated entries.

READING AT RETURN. The operator enters reading when the equipment is returned. If the miles/hours/kilometers meter is broken or missing, estimate the miles/hours/kilometers used on equipment.

OIL ADDED (IN QUARTS). The operator enters the amount of oil in quarts added while the equipment was on dispatch.

**Figure 2-7. Sample ULLS-generated DA Form 5987-E**

---

DATE: 20031126

MOTOR EQUIPMENT DISPATCH

C CO. 3/7 INF  
 BLD 1265  
 FSGA 31315

UIC: WAQYCO

PHONE NUMBER: (912)767-3079

DATE DISPATCHED: 20031201

TIME DISPATCHED: 0100

----- EQUIPMENT DATA -----

ADMIN NUM: C11  
 EQUIP MODEL: M2A2WODS  
 EQUIP NOUN: INFANTRY FIGHTING VEH  
 EQUIP NSN: 2350014059886  
 SERIAL NUM: 2ADRO120F  
 REGISTRATION NUM: MV06JP  
 EQUIP LICENSE NUM:  
 KEY NUM:

----- DISPATCH INFORMATION -----

OFFICIAL USER NAME/PHONE NUM: / 767-7762

DESTINATION: FSGA  
 EXPECTED DATE/TIME OF RETURN: 20031231 / COB OR 2359

EQUIP DISPATCHER'S SIGNATURE: \_\_\_\_\_  
 SPC HILL, JOSHUA

1ST OPERATOR'S SIGNATURE: \_\_\_\_\_

2ND OPERATOR'S SIGNATURE: \_\_\_\_\_

AUTHORIZATION: \_\_\_\_\_

RELEASED BY: \_\_\_\_\_

DISPATCH OUT REMARKS: MUST BE SIGNED BY COMPANY COMMANDER  
 ----- END ITEM USAGE DATA -----

EQUIPMENT NOUN	M/H/K	CURRENT READING	READING AT RETURN	FUEL USAGE (IN GALLONS)
INFANTRY FIGHTING VEH	K	-----	_____	_____

----- COMPONENT(S) USAGE DATA -----

SERIAL NUMBER	COMPONENT NOUN	M/H/K	CURRENT READING	READING AT RETURN	OIL ADDED (IN QUARTS)
1263	TRANSMISSION	K	-----	_____	_____
37158063	ENGINE	K	-----	_____	_____

Notes:

<sup>1</sup> The Alert dispatch summary sheet printed at the end of the Alert dispatch forms may be used as a dispatch control log for alert dispatches.

Legend for Figure 2-8;

completion instructions follow. Unit address, telephone number, and UIC are retrieved automatically from the database; no entries required from the operator.

DATE DISPATCHED. The date equipment is dispatched. ULLS default entry.

TIME DISPATCHED. The military time equipment is dispatched. ULLS default entry.

Figure 2-8. Sample ULLS-generated DA Form 5987-E-1

EQUIPMENT DATA. Administrative number, equipment model number, equipment noun, equipment NSN, equipment serial number, registration number, equipment license number, and key number are retrieved automatically from equipment data file; no entries are required from the operator.

DISPATCH INFORMATION. Some information in this section is retrieved automatically from the ULLS database based upon user input; Operator/supervisor reviews this section and takes appropriate actions as required by filling in the fields below.

OFFICIAL USER NAME/PHONE NUM. The operator requesting the dispatch provides the last name, first name, middle initial, rank/grade, and telephone number to the dispatcher. Dispatcher enters the name of the person to whom the operator is to report (official user). This person is responsible for the equipment when in use.

DESTINATION. The dispatcher enters the location of dispatch area into the ULLS system.

EXPECTED DATE/TIME OF RETURN. Dispatcher enters close of business or the actual time the user expects to return with the equipment. The operator ensures the dispatcher reviews the expected date/time of return. If equipment cannot be returned because of mission, operator will notify the official user, who requests an extended dispatch.

EQUIP DISPATCHER'S SIGNATURE. The dispatcher signs his/her name.

1ST OPERATOR'S SIGNATURE. The operator signs his/her name. If operators are changed while the vehicle is dispatched, annotate the hours/miles/kilometers on the equipment to the right of the operators signature.

2ND OPERATOR'S SIGNATURE. This line is used if operators are changed while the equipment is on dispatch. This normally happens when an operator becomes sick or overly tired (for example, during convoy operations). The operator signs his/her name.

AUTHORIZATION. This block/area can be used for off post authorization. The commander or the commander's designated representative signs and enters rank for off post travel. For second or third operator authorization: When in a situation of change drivers and there is no dispatcher present to verify a drivers qualifications, enter the name and rank of person authorizing the change or modification.

RELEASED BY. The person in charge of the equipment on dispatch or senior person present signs on the line showing the place where the mission was completed, releasing the equipment to the maintenance facility or place of origin. The person normally signing the RELEASED BY block may be different from the person shown in the OFFICIAL USER block when the person designated in the OFFICIAL USER is not available. The person in charge and responsible for the safety and operation of the equipment and operator signs in that case.

DISPATCH OUT REMARKS. The dispatcher enters all towed equipment by the prime mover. If equipment was extended the operator writes the words EXTENDED DISPATCH, the name and rank/grade of the person authorizing the extension, and expected date of return. The official user or the commander's designated representative signs and enters rank when operator is released or mission is completed.

END ITEM USAGE DATA. Equipment noun, miles/hours/kilometers and current reading are ULLS- generated entries.

EQUIPMENT NOUN. Self-explanatory.

M/H/K. This displays how equipment is tracked, by either miles/hours/kilometers.

CURRENT READING. Operator is not required to enter this.

READING AT RETURN. Operator enters this at time of return.

FUEL USAGE (IN GALLONS). The operator enters the amount of fuel in gallons added while the equipment was on dispatch.

COMPONENT(S) USAGE DATA. Components serial number, noun, and miles/hours/kilometers are generated automatically by ULLS.

CURRENT READING Operator is not required to enter this.

READING AT RETURN. The operator enters reading when the equipment is returned. If the miles/hours/kilometers meter is broken or missing, estimate the miles/hours/kilometers used on equipment.

OIL ADDED (IN QUARTS). The operator enters the amount of oil in quarts added while the equipment was on dispatch.

**Figure 2-8. Sample ULLS-generated DA Form 5987-E-1**

---

MOTOR EQUIPMENT UTILIZATION RECORD							
DATE (YYMMDD)	TYPE OF EQUIPMENT	REGISTRATION NO./SERIAL NO.			ADMINISTRATION NO.		
970114	TRK CGO M923	NLØDUU			B401 W/TLR B40IT		
ORGANIZATION NAME Co B 142 ECB (HV)		ACTION	TIME	MILES	HOURS	FUEL	OIL
1ST OPERATOR (Last Name, First, M.I.) MOSZER, RICHARD A. PFC		IN	1645	13045	1099	46 GAL	E 20TS 1 QT
OPERATOR'S SIGNATURE Richard A. Moszer		OUT	0800	12960	1096	REPORT TO (Last Name, First, M.I.) STRANDE, JERRY L. CWS3	
2D OPERATOR (Last Name, First, M.I.) PERSHKE, MARILEE A. SSG		TOTAL	8:45	85	3	DISPATCHER'S SIGNATURE Nancy A. Franke	
OPERATOR'S SIGNATURE Marilee A. Pershke		IN	1545	13075	1101	REPORT TO (Last Name, First, M.I.) THOMAS, RICHARD J. SFC	
3D OPERATOR (Last Name, First, M.I.) MOSER, DALE D. SGT		OUT	1000	13045	1099	DISPATCHER'S SIGNATURE Nancy A. Franke	
OPERATOR'S SIGNATURE Dale D. Moser		TOTAL	5:45	30	2	REPORT TO (Last Name, First, M.I.) PERSHKE, ROGER G. MSG	
4TH OPERATOR (Last Name, First, M.I.)		IN	1830	13185	1105	DISPATCHER'S SIGNATURE Nancy A. Franke	
OPERATOR'S SIGNATURE		OUT	0700	13075	1101	REPORT TO (Last Name, First, M.I.)	
TOTAL		IN				DISPATCHER'S SIGNATURE	
TOTAL		OUT				DISPATCHER'S SIGNATURE	
TOTAL		TOTAL				DISPATCHER'S SIGNATURE	
DESTINATION		TIME		RELEASED BY		REMARKS	
FROM		ARRIVE	DEPART	(Signature)			
1. Motor Pool			0830				
TO				Jerry L. Strande			
2. CAMP GRAFTON South		1000	1500				
TO						FUEL: 14 GAL	
3. Motor Pool		1630					
TO				970115			
4.							
TO							
5. Motor Pool			1030				
TO				Richard J. Thomas			
6. TRNG AREA #17		1115	1440				
TO						FUEL: 6 GAL.	
7. Motor Pool		1530					
TO				970116			
8.							
TO							
9. Motor Pool			0730				
TO				Roger A. Pershke		E OIL: 1 QT	
10. DEMO RANGE		0930	1630				
TO						FUEL: 20 GAL	
11. Motor Pool		1815					
TO							
12.							
TO							
13.							
TO							
14.							
TO							
15.							
TO							
16.							

DD FORM 1970  
APR 81

EDITION OF FEB 75 MAY BE USED.

## Notes:

<sup>1</sup> More than one component on an end item can be under the AOAP; for example, the engine and transmission. When that occurs, divide the OIL block into sections, one for each component covered, and enter the oil added for each separately. Print the first letter of the component at the top left corner of the section to indicate which section applies to which component.

Legend for Figure 2-9;

completion instructions follow.

DATE (YYMMDD). The dispatcher puts the date the form is started. The date is reflected as two places for the year, two for the month, and two for the day (for example, 970201).

TYPE OF EQUIPMENT. The dispatcher enters the equipment noun and model.

Figure 2-9. Sample DD Form 1970 for dispatch

REGISTRATION NO./SERIAL NO. The dispatcher puts in the serial number of the equipment. For equipment managed by registration number, enter the registration number.

ADMINISTRATION NO. The dispatcher enters the equipment bumper number. If the equipment does not have an assigned bumper number, enter the administration number. If the equipment is dispatched with a trailer or other item, include the item bumper or administration number.

ORGANIZATION NAME. The dispatcher enters the organization to which the equipment is assigned.

1ST OPERATOR (*Last Name, First, M.I.*)

1. The dispatcher prints the name or names of the operator or operators of the equipment in blocks provided. Enter the last name first, followed by the first name, middle initial, and then rank/grade.
2. Operators may change after equipment has been dispatched. This normally happens when an operator becomes sick, overly tired, and so on. The operator's supervisor or leader, OIC, or NCOIC closes out the first operator's entry and logs the IN time and miles/hours in the ACTION section for that operator. The new operator's name goes in the next OPERATOR block. The supervisor or leader signs in the next open DISPATCHER'S SIGNATURE block. If the OPERATOR blocks are filled, enter the names, time, and miles/hours in the REMARKS block.

OPERATOR'S SIGNATURE. The operator or operators sign in this block.

ACTION. This section shows the time and miles or hours on the equipment when it is dispatched and returned.

TIME. Show time on the 24-hour clock to the nearest 5 minutes.

IN. Show the time the equipment came back from dispatch or other use.

OUT. Enter the time the equipment was released by the dispatcher.

TOTAL. Subtract the OUT time from the IN time to get the total time the operator had the equipment in use. Separate hours and minutes by putting a colon (:) between them. Five hours and 20 minutes is printed 5:20.

MILES. Figure distance to the nearest mile or kilometer.

IN. The operator enters the miles or kilometers from the odometer when the equipment comes off the dispatch. If the odometer is broken, estimate the miles or kilometers. Enter EST in front of the number.

OUT. The dispatcher enters the miles or kilometers from the odometer when the equipment is dispatched. If the odometer is broken, enter EST in front of the estimated miles or kilometers.

TOTAL. Subtract the OUT hours from the IN hours. This total shows the number of hours used during the dispatch or operation. If the hourmeter is broken, enter EST in front of the number.

HOURS. Figure hours to the nearest whole hour.

IN. The operator enters the hours from the hourmeter when the equipment comes off dispatch or other use. If the hourmeter is broken or missing, estimate the hours of use. Enter EST in front of the number.

OUT. The dispatcher enters the hours on the hourmeter when the equipment is dispatched. If the hourmeter is broken, write EST in front of the number.

TOTAL. Subtract the OUT hours from the IN hours. This total shows the number of hours used during the dispatch or operation. If the hourmeter is broken, enter EST in front of the number.

FUEL. If required locally, the dispatcher keeps a running total of fuel added to the equipment. This entry shows how much fuel has been added to date when the form was started. The local SOP states how long fuel totals are carried.

OIL. For equipment under the AOAP, the dispatcher keeps a running total of oil added to the equipment. This entry shows how much oil has been added for the current period when the form was started. Oil added totals are only kept between oil samples. When a new sample is taken, the total goes back to zero and the process starts over. For equipment not under AOAP, use this block as required locally.

REPORT TO (*Last Name, First, M.I.*). The dispatcher prints the name of the person to whom the operator is to report. Give the last name, first name, middle initial, and rank/grade of the person. This person is responsible for the equipment when in use.

DISPATCHER'S SIGNATURE. The dispatcher signs when the equipment is dispatched.

DESTINATION. Enter the beginning point of the dispatch, the ending point, any off-post travel stops, or the major operating point. For forms showing dispatches to support maintenance, note miles used by operational or road tests from a DA Form 2407. Print Road Test or Operational Test in the DESTINATION block.

FROM. Enter start point of dispatch.

TO. Enter destination of dispatch.

TIME. Use the 24-hour clock rounded off to the nearest 5 minutes.

ARRIVE. Log in the time of arrival at the place. For forms showing dispatches to support maintenance, account for miles/hours used for operation or road tests. Enter the miles/hours on the item upon delivery to support.

DEPART. Log in the time of departure from this place. For forms showing dispatches to support maintenance, account for miles/hours used for operation or road test. Enter the miles/hours on the item upon receipt from support.

RELEASED BY (*Signature*).

1. The person in charge of the equipment on dispatch or senior person present signs on the line showing the place where the mission was completed, releasing the equipment to the maintenance facility or place of origin. The person signing the RELEASED BY block may be different from the person shown in the REPORT TO block when the person designated in the REPORT TO block is not available. The person in charge and responsible for the safety and operation of the equipment and operator signs in that case.
2. Normally the person signing here is an officer or NCOIC.
3. Passengers of equipment used as taxis do not sign in this column. In that situation, the dispatcher signs this column when the equipment returns.

**Figure 2-9. Sample DD Form 1970 for dispatch**

4. Signature in this block shows that when an official user has completed the mission with the vehicle and driver, the senior occupant assumes vehicle responsibility.

5. Note the change of days. Draw a line through the next open line under the last entry of a day. Enter the new date (YYMMDD) in the RELEASED BY (*Signature*) block.

REMARKS.

1. The operator or user reports any unusual or abnormal situations. This includes such things as accidents, breakdowns, unplanned stops or changes in location. Any unusual operations and faults on the equipment go on DA Form 2404.

2. The operator lists any oil added to equipment on components under AOAP.

3. Fuel added is logged if required locally.

4. Enter the word Exercised when low usage equipment is exercised.

5. Note the change of days. Draw a line through the next open line under the last entry of a day. Enter the new date (YYMMDD) in the RELEASED BY (*Signature*) block. When the equipment is not operated for more than 1 day in a row, one line may be used to cover the combined time. Print "Did not operate" in the REMARKS block.

**Figure 2–9. Sample DD Form 1970 for dispatch**

---



MOTOR EQUIPMENT UTILIZATION RECORD								
DATE (YYMMDD)	TYPE OF EQUIPMENT	REGISTRATION NO./SERIAL NO.			ADMINISTRATION NO.			
970117	TRK CGO M923	NLØDUU			B401			
ORGANIZATION NAME Co B 142 ECB (HV)		ACTION	TIME	MILES	HOURS	FUEL	OIL E 3QTS	T 2QTS
1ST OPERATOR (Last Name, First, M.I.) HARTL, John W. II SGT		IN	1700	13280	1108	86 GAL		
OPERATOR'S SIGNATURE John W. Hartl II		OUT	0700	13185	1105	TURCK, BRADLEY B. SFC		
2D OPERATOR (Last Name, First, M.I.) OLERUD, Eric A. SFC		TOTAL	10:00	95	3	KEMMETH R. OSTBY		
OPERATOR'S SIGNATURE Eric A. Olerud		IN	1530	13603	1118	MOENCH, DALE D. MSG		
3D OPERATOR (Last Name, First, M.I.)		OUT	0830	13280	1108	KEMMETH R. OSTBY		
OPERATOR'S SIGNATURE		TOTAL	55:00	323	10	DISPATCHER'S SIGNATURE		
4TH OPERATOR (Last Name, First, M.I.)		IN				DISPATCHER'S SIGNATURE		
OPERATOR'S SIGNATURE		OUT				DISPATCHER'S SIGNATURE		
		TOTAL				DISPATCHER'S SIGNATURE		
DESTINATION		TIME		RELEASED BY		REMARKS		
		ARRIVE	DEPART	(Signature)				
FROM								
1. Motor Pool			0730					
TO								
2. AMMO Point		0800	0900					
TO								
3. M203 RANGE		1000	1430					
TO								
4. AMMO Point		1530	1600	Bradley B. Turck		FUEL: 17 GAL.		
TO								
5. Motor Pool		1630						
TO								
6.				970118		970120 EXTENDED DISPATCH		
TO								
7. Motor Pool			0900			ASST. OP. AASER, PAUL L. SGT		
TO								
8. FTX		1400				FUEL: 26 GAL.		
TO								
9.				970119				
TO								
10. FTX						DID NOT OPERATE		
TO								
11.				970120				
TO								
12. FTX			1000	Dale D. Moench		E OIL: 1QT		
TO								
13. Motor Pool		1500				FUEL: 27 GAL.		
TO								
14.								
TO								
15.								
TO								
16.								

DD FORM 1970  
APR 81

EDITION OF FEB 75 MAY BE USED.

## Notes:

<sup>1</sup> More than one component on an end item can be under AOAP; for example, the engine and transmission. When that occurs, divide the OIL block into sections, one for each component covered, and enter the oil added for each separately. Print the first letter of the component at the top left corner of the section to indicate which section applies to which component.

Figure 2-10. Sample DD Form 1970 for extended dispatch

Legend for Figure 2–10;

completion instructions follow.

DATE (YYMMDD). The dispatcher puts the date the form is started. The date is reflected as two places for the year, two for the month, and two for the day (example, 961222).

TYPE OF EQUIPMENT. The dispatcher enters the equipment noun and model.

REGISTRATION NO./SERIAL NO. The dispatcher puts in the serial number of the equipment. For equipment managed by registration number, enter the registration number.

ADMINISTRATION NO. The dispatcher enters the equipment bumper number. If the equipment does not have an assigned bumper number, enter the administration number. If the equipment is to be dispatched with a trailer or other item, include the item bumper or administration number.

ORGANIZATION NAME. Self-explanatory.

1ST OPERATOR (*Last Name, First, M.I.*).

1. The dispatcher prints the name or names of the operator or operators of the equipment in blocks provided. Enter the last name first followed by the first name, middle initial, and then rank/grade.

2. Operators may change after equipment has been dispatched. This normally happens when an operator becomes sick or overly tired. The operator's supervisor or leader, OIC, or NCOIC closes out the first operator's entry. He or she logs the IN time and miles/hours in the ACTION section for that operator. The new operator's name goes in the next OPERATOR block. The supervisor or leader signs in the next open DISPATCHER'S SIGNATURE block. If the OPERATOR blocks are all filled, enter the names, time, and miles/hours in the REMARKS block.

3. For convoy or other long operation where an operator and assistant operator switch at each rest stop, show a change in operators only when destinations or date entries are made. The assistant's operator name is shown in the REMARKS block.

OPERATOR'S SIGNATURE. The operator or operators sign in this block.

ACTION. This section shows the time and miles or hours on the equipment when it is dispatched and returned.

TIME. Show time in 24-hour clock to the nearest 5 minutes.

IN. Show the time the equipment came back from dispatch or other use.

OUT. Enter the time when the equipment was released by the dispatcher.

TOTAL. Subtract the OUT time from the IN time to get the total time the operator had the equipment in use. Separate hours and minutes by putting a colon (:) between them. Five hours and 20 minutes is printed 5:20.

MILES. Figure miles to the nearest mile or kilometer.

IN. The operator enters the miles or kilometers from the odometer when the equipment comes off the dispatch. IF the odometer is broken, estimate the miles or kilometers. Enter EST in front of the number.

OUT. The dispatcher enters the miles or kilometers on the odometer when the equipment is dispatched. If the odometer is broken, enter EST in front of the estimated miles or kilometers.

TOTAL. Subtract the OUT miles or kilometers from the IN miles. This total shows the number of miles or kilometers the equipment traveled during the dispatch. If the odometer is broken, enter EST in front of the figure.

HOURS. Figure hours to the nearest whole hour.

IN. The operator enters the hours from the hourmeter when the equipment comes off dispatch or other use. If the hourmeter is broken or missing, estimate the hours of use. Enter EST in front of the number.

OUT. The dispatcher enters the hours from the hourmeter when the equipment is dispatched. If the hourmeter is broken, write EST in front of the number.

TOTAL. Subtract the OUT hours from the IN hours. This total shows the number of hours used during the dispatch or operation. If the hourmeter is broken, enter EST in front of the number.

FUEL. IF required locally, the dispatcher keeps a running total of fuel added to the equipment. This entry shows how much fuel has been added to date when the form was started. Local SOP states how long fuel totals are carried.

OIL. For equipment under the AOAP, the dispatcher keeps a running total of oil added to the equipment. This entry shows how much oil has been added for the current period when the form was started. Oil added totals are kept only between oil samples. When a new sample is taken, the total goes back to zero and the process starts over. For equipment not under AOAP, use this block as required locally.

REPORT TO (*Last Name, First, M.I.*). The dispatcher prints the name of the person to whom the operator is to report. Give the last name, first name, middle initial, and rank/grade of the person. This person is responsible for the equipment when in use.

DISPATCHER'S SIGNATURE. The dispatcher signs when the equipment is dispatched.

DESTINATION. Enter the beginning point of the dispatch, the ending point, any off-post travel stops, or the major operating point.

FROM. Enter the start point of dispatch.

TO. Enter destination of dispatch.

TIME. Use the 24-hour clock rounded off to the nearest 5 minutes.

ARRIVE. Log in the time of arrival at the place.

DEPART. Log in the time of departure from this place.

RELEASED BY (*Signature*).

**Figure 2–10. Sample DD Form 1970 for extended dispatch**

---

1. The person in charge of the equipment on dispatch or senior person present signs on the line showing the place where the mission was completed, releasing the equipment to the maintenance facility or place of origin. Enter first name, middle initial, last name. The person signing in the RELEASED BY block may be different from the person shown in the REPORT TO block when the person designated in the REPORT TO block is not available. In that case, both the person in charge and responsible for the safety and operation of the equipment and the operator sign.
2. Normally the person signing here is an officer or NCOIC.
3. Signature in this block shows that when an official user has completed the mission with the vehicle and driver, the senior occupant assumes vehicle responsibility.

REMARKS.

1. The operator or user reports any unusual or abnormal situations. This includes such things as accidents, breakdowns, unplanned stops, or changes in location. Any unusual operations and faults on the equipment go on DA Form 2404.
2. The operator lists any oil added to equipment or components under AOAP.
3. Fuel added is logged if required locally.
4. Note the change of days. Draw a line through the next open line under the last entry of a day. Enter the new date (YYMMDD) in the RELEASED BY (*Signature*) block. When the equipment is not operated for more than 1 day in a row, one line may be used to cover the combined time. Print "Did Not Operate" in the REMARKS block.
5. Additional Report to entries may be needed. Print the name of the next Report to in the REMARKS block for the entry. Also, for extended dispatch, the dispatcher enters EXTENDED DISPATCH and the expected date of return on the first line of the REMARKS block.
6. If an extended dispatch is so long that a form may be completed, another DD Form 1970 may be used as a continuation sheet. Enter the equipments registration or serial number and admin number at the top of the form. Print Continuation in the upper left hand corner of the form. Then make normal entries as required.

**Figure 2-10. Sample DD Form 1970 for extended dispatch**

---

MOTOR EQUIPMENT UTILIZATION RECORD							
DATE (YYMMDD)	TYPE OF EQUIPMENT	REGISTRATION NO./SERIAL NO.			ADMINISTRATION NO.		
970117	GEN ST MEP-OISA	1631236			B-6G		
ORGANIZATION NAME Co B 142 ECB (HY)		ACTION	TIME	MILES	HOURS	FUEL	OIL
1ST OPERATOR (Last Name, First, M.I.) SAILER, William M. SFC		IN				REPORT TO (Last Name, First, M.I.) THOMAS RICHARD J. SFC	
OPERATOR'S SIGNATURE <i>William M. Sailer</i>		OUT				DISPATCHER'S SIGNATURE <i>Kenneth R. Oatby</i>	
2D OPERATOR (Last Name, First, M.I.) ZIMMERMAN, Alvin M. SFC		TOTAL				REPORT TO (Last Name, First, M.I.) ZENTNER, LAWRENCE L. MSG	
OPERATOR'S SIGNATURE <i>Alvin M. Zimmerman</i>		IN				DISPATCHER'S SIGNATURE <i>Kenneth R. Oatby</i>	
3D OPERATOR (Last Name, First, M.I.)		OUT				REPORT TO (Last Name, First, M.I.)	
OPERATOR'S SIGNATURE		TOTAL				DISPATCHER'S SIGNATURE	
4TH OPERATOR (Last Name, First, M.I.)		IN				REPORT TO (Last Name, First, M.I.)	
OPERATOR'S SIGNATURE		OUT				DISPATCHER'S SIGNATURE	
		TOTAL					
DESTINATION	TIME		RELEASED BY (Signature)	REMARKS			
	ARRIVE	DEPART					
FROM							
1.				197 hrs			
TO				970120			
2.				EXTENDED DISPATCH			
TO							
3.	970117	0800 1000		2 hrs			
TO							
4.	970118	0700 1100		4 hrs FUEL: 3 GAL.			
TO							
5.	970119	0700 1100		4 hrs			
TO							
6.	970120	0700 1100	<i>Richard J. Thomas</i>	4 hrs FUEL: 4 GAL.			
TO							
7.	970121	0700 1300	<i>Lawrence L. Zentner</i>	6 hrs FUEL: 3 GAL.			
TO							
8.							
TO							
9.							
TO							
10.							
TO							
11.							
TO							
12.							
TO							
13.							
TO							
14.							
TO							
15.							
TO							
16.							

DD FORM 1970  
APR 81

EDITION OF FEB 75 MAY BE USED.

Legend for Figure 2-11;

completion instructions follow.

DATE (YYMMDD). The dispatcher puts the date the form is started. The date is reflected as two places for the year, two for the month, and two for the day (for example, 970120).

TYPE OF EQUIPMENT. The dispatcher enters the equipment noun and model.

REGISTRATION NO./SERIAL NO. The dispatcher puts in the serial number of the equipment. For equipment managed by registration number, enter the registration number.

ADMINISTRATION NO. The dispatcher enters the equipment bumper number. If the equipment does not have an assigned bumper number, enter the equipment administration number. If the equipment is dispatched with a trailer, or other item, include that item's bumper or administration number.

ORGANIZATION NAME. The dispatcher enters the organization to which the equipment is assigned.

1ST OPERATOR (Last Name, First, M.I.).

Figure 2-11. Sample DD Form 1970 for operating time

1. The dispatcher prints the name or names of the operator or operators of the equipment. Enter the last name first, followed by the first name, middle initial, and then rank/grade.
2. Operators may change after equipment has been dispatched. This normally happens when an operator becomes sick, overly tired, and so on. The operators supervisor/leader, office in charge (OIC), or noncommissioned officer in charge (NCOIC) closes out the first operator's entry. He or she logs IN time and miles/hours in the ACTION section for that operator. The new operator's name goes in the 2ND OPERATOR block. The supervisor/leader signs in the next open DISPATCHER'S SIGNATURE block. If the OPERATOR blocks are all filled, enter the names in the REMARKS block.

OPERATOR'S SIGNATURE. The operator or operators sign in this block.

ACTION.

TIME. Leave blank.

IN. Leave blank.

OUT. Leave blank.

TOTAL. Leave blank.

MILES. Leave blank.

IN. Leave blank.

OUT. Leave blank.

TOTAL. Leave blank.

HOURS. Leave blank.

IN. Leave blank.

OUT. Leave blank.

TOTAL. Leave blank.

FUEL. If required locally, the dispatcher keeps a running total of fuel added to the equipment. This entry shows how much fuel has been added to date when the form was started. Local SOP states how long fuel totals are to be carried.

OIL. For equipment under the AOAP, the dispatcher keeps a running total of oil added to the equipment. This entry shows how much oil has been added for the current period when the form was started. Oil added totals are only kept between oil samples. When a new sample is taken, the total goes back to zero and the process starts over. For equipment not under AOAP, use this block as required locally.

REPORT TO (*Last Name, First, M.I.*). The dispatcher prints the name of the person to whom the operator is to report. Give the last name, first name, middle initial, and rank/grade of the person. The person is responsible for the equipment when in use.

DISPATCHER'S SIGNATURE. The dispatcher signs when the equipment is dispatched.

DESTINATION.

FROM. Leave blank.

TO. Enter the date (YYMMDD).

TIME. These blocks are used to show starting and stopping times for each operation.

ARRIVE. For equipment without an hourmeter, enter the 24-hour clock time (for example, 1300) when the equipment's operation was started. For equipment with an hourmeter, enter the hours on the equipment when this operation was started.

DEPART. For equipment without an hourmeter, enter the 24-hour clock time (for example, 1300) when the equipments operation was stopped. For equipment with an hourmeter, enter the hours on the equipment when this operation was stopped.

RELEASED BY (*Signature*).

1. The person in charge of the equipment signs in this column.
2. The person signing here is an officer or NCOIC.
3. Signature in this block shows that when an official user has completed the mission with the vehicle and driver, the senior occupant assumes vehicle responsibility.

REMARKS.

1. When starting a new form for equipment without an hourmeter, enter the accumulative hours on the equipment in LINE 1, REMARKS block.
2. Equipment without an hourmeter, subtract the start time in the ARRIVE block from the stop time in the DEPART block. Enter the number of hours in the REMARKS block.
3. The operator or user reports any unusual or abnormal situations. This includes accidents, breakdowns, unplanned stops, or changes in location, and so forth. Any unusual operations and faults on the equipment go on DA Form 2404.
4. The operator lists any oil added to equipment or components under AOAP.
5. Fuel added is logged if required locally.
6. When the form has been completed, add the REMARKS block hours and the accumulative hours, and post on a new DD Form 1970 in the REMARKS block.

**Figure 2–11. Sample DD Form 1970 for operating time**

---

DATE: 20031204                      DISPATCH CONTROL LOG                      DA FORM 5982-E

DODAAC: W33VT3                      A CO 3RD BN 7TH INF                      UIC: WAQYAO  
 ADMIN NUMBER: A24                      DESTINATION: FSGA 31314  
 D/L AUTH:                      SCH SVC AUTH:                      DISPATCHER: SPC ROMERO

DATE/TIME DISPATCHED                      DATE/TIME EXP RETURN                      DATE/TIME RETURNED  
 20031120 / 0947                      20031120 / 1730                      ----- / ----

OPERATOR #1 NAME/LIC NUM: GREEN                      / G5555                      REMARKS IN:  
 OPERATOR #2 NAME/LIC NUM:                      /

OFFICIAL USER'S NAME/PHONE:                      / -----  
 REMARKS OUT: FINAL ROAD TEST

---

ADMIN NUMBER: A3                      DESTINATION: FSGA 31314  
 D/L AUTH:                      SCH SVC AUTH:                      DISPATCHER: PFC CORDERO ELIUD

DATE/TIME DISPATCHED                      DATE/TIME EXP RETURN                      DATE/TIME RETURNED  
 20031202 / 1303                      20031205 / 1730                      ----- / ----

OPERATOR #1 NAME/LIC NUM: MARTINDALE                      / M3965                      REMARKS IN:  
 OPERATOR #2 NAME/LIC NUM:                      /

OFFICIAL USER'S NAME/PHONE:                      / -----  
 REMARKS OUT: FIELD EXERCISE, ROADMARCH

---

ADMIN NUMBER: A4                      DESTINATION: FSGA 31314  
 D/L AUTH:                      SCH SVC AUTH:                      DISPATCHER: PFC CORDERO ELIUD

DATE/TIME DISPATCHED                      DATE/TIME EXP RETURN                      DATE/TIME RETURNED  
 20031202 / 1312                      20031205 / 1730                      ----- / ----

OPERATOR #1 NAME/LIC NUM: DUNN                      / D5975                      REMARKS IN:  
 OPERATOR #2 NAME/LIC NUM:                      /

OFFICIAL USER'S NAME/PHONE:                      / -----  
 REMARKS OUT: FIELD

---

ADMIN NUMBER: A6                      DESTINATION: FSGA 31314  
 D/L AUTH:                      SCH SVC AUTH:                      DISPATCHER: PFC CORDERO ELIUD

DATE/TIME DISPATCHED                      DATE/TIME EXP RETURN                      DATE/TIME RETURNED  
 20031202 / 1129                      50031205 / 1730                      ----- / ----

OPERATOR #1 NAME/LIC NUM: JOHNSON                      / J3496                      REMARKS IN:  
 OPERATOR #2 NAME/LIC NUM:                      /

OFFICIAL USER'S NAME/PHONE:                      / 000-0000  
 REMARKS OUT: FIELD

- Legend for Figure 2-12;  
 completion instructions follow.
- a. This listing is produced as required. However, this form is always produced prior to purging the Dispatch Control Log when equipment has been involved in an accident or other situation under investigation. Dispose of the listing after the investigation is complete. For other than investigations, dispose of in accordance with local SOP.
  - b. This listing replaces the requirement to maintain a DA Form 2401.
  - c. All entries are self-explanatory, except deadlined authorization, which should be initialed by the commander to indicate that a vehicle has been authorized for dispatch under a CIRCLED X condition. The ULLS-G program is indicated when this field should be initialed.
  - d. Scheduled service authorization is not used at this time.

**Figure 2-12. Sample ULLS-generated DA Form 5982-E**

ORGANIZATIONAL CONTROL RECORD FOR EQUIPMENT For use of this form, see DA PAM 750-8; the proponent agency is DCS G-4.										DATE (YYYYMMDD) 25 OCT 11 05	PAGE NO.	NO. OF PAGES
OFFICIAL USER a	REPORTING POINT b	PHONE EXT. NUMBER c	TIME TO REPORT d	EXPECT TIME OF RETURN e	DESTINATION f	UNIT IDENTIFICATION NUMBER g	TYPE OF EQUIP- MENT h	REGISTRATION NUMBER i	OPERATOR'S NAME AND GRADE j	TIME		REMARKS m
										OUT k	IN l	
JONES, JAMES SFC	BLDG 6309	1367	0800	COB	TRNG AREA #21	B-15	M1083	NK02DB	FRANK, JOSEPH, SP4	0745	1705	W/TLR B-T-15
KLEIN, ALLEN SSG	BLDG 1850	1529	0800	1700	CAMP GRAFTON, SC	B-9	M1037	NG01A2	NEIS, FRED M, PFC	0750	1130	
RANKIN, GARY SGT	TRNG AREA #21	1635	0900	6 NOV 1300		B-7	MEP C15A	1742347	NELSON, DAN, SP4	0900	6 NOV 1100	EXTENDED DISPATCH 6 NOV 2004
SMITH, CHARLES SFC	BLDG 2300	1725	0930	1700	CLARKSVILLE, TN	B-19	M984 WW	NP04AA	CONDOR, LEWIS, PFC	0900	1700	
					4 NOV 2004							Arthur Treacher
EMERICK, GLEN SFC	BLDG 2605	1098	0815	COB	TRNG AREA #35	B-15	M1083	NK02DB	SHORT, CHRIS, PFC	0800	1420	W/TLR B-T-15
ZIMMER, TIM CW4	SUPPLY ROOM	1415	0900	1200	CLASS II WAREHOUSE	B-20	M1037	NK02LM	MOENCH, DALE PFC	0845	1200	
FELCH, AERB SFC	BLDG 1310	1416	0930	1600	CSMS	B-2	M98 WW	NP0321	QUIRK, DON PFC	0900	1610	Mark J. Hemmel
SMITH, JOE ALT	BLDG 2300	1725	1015	6 NOV 0930	FTX	B-22	M1083	NK011D	SMITHSON, CHAD, PVT	1000	6 NOV 1000	EXTENDED DISPATCH 6 NOV 2004
					5 NOV 2004							Arthur Treacher

DA FORM 2401, AUG 2004

EDITION OF APR 82 IS OBSOLETE.

AFD V1.00

Legend for Figure 2-13;

completion instructions follow.

DATE (YYYYMMDD)

PAGE NO. Fill in as required locally.

NO. OF PAGES. Fill in as required locally.

DISPATCHER. The dispatcher signs name.

OFFICIAL USER a. Print the name of the person or activity asking for the equipment. Enter last name, first name, MI and rank/grade.

REPORTING POINT b.

1. For a vehicle, write the place or unit where the operator is to report with the equipment.

2. For other than vehicles, write the location or place where the equipment is to be operated.

PHONE EXT NUMBER c. The telephone number of the person asking for the equipment.

TIME TO REPORT d. The time the operator is to report to the location in REPORTING POINT b.

EXPECT TIME OF RETURN e. Enter Close of Business (COB) or the actual time the user expects to return with the equipment. For extended dispatches, enter the date and time (if known) that the user expects to return the equipment.

DESTINATION f.

1. For vehicles, enter the place, farthest away, that the vehicle is expected to travel.

2. For other equipment, enter the location where the equipment is operating that is farthest away from its normal site. If column f is the same as column b, leave this column blank.

UNIT IDENTIFICATION NUMBER g. The equipment bumper or admin number.

TYPE OF EQUIPMENT h. Enter the equipments model identification number (for example, M35A2).

REGISTRATION NUMBER i. Enter the equipment serial number. For equipment managed by registration number, enter the registration number in this column.

OPERATOR'S NAME AND GRADE j. Enter the last name, first name, MI, and rank/grade of the equipment operator.

TIME OUT k. Log in the time the equipment was dispatched.

TIME IN l.

1. Log in the time the equipment returned. Get this time from the IN block of DD Form 1970.

2. For equipment coming off an extended dispatch, enter the day, month, and time of return in this column.

REMARKS m.

1. When an assistant or second operator is needed, enter that persons last name, MI, and rank/grade.

2. When a change of dispatcher takes place during the day, the new dispatcher signs the column m for that item dispatched. When a change of dispatcher takes place during the beginning of the day, the new day dispatcher signs in column m on the date line.

3. Note any towed equipment that will come back with the prime mover, in this column. Write the noun for the towed equipment here. (Make separate entries for towed equipment that will not come back with the prime mover.) Treat towed equipment that will not come back with the prime mover as if it were not towed. Complete all columns except the expected time of return.

4. For equipment on extended dispatch, enter the words, EXTENDED DISPATCH and the expected date of return.

Figure 2-13. Sample DA Form 2401

5. Identify equipment involved in accidents or unusual circumstances.
6. If more room is needed, use the next open line. Line out all unneeded columns (a-f).

Figure 2-13. Sample DA Form 2401

---

## Chapter 3 Maintenance Processes, Forms and Records

### 3-1. General

This chapter explains how to plan, manage, report and control maintenance and maintenance related shop/section supply related functions when using ULLS-G and SAMS automation. It also explains how to use manual procedures for scheduling, performing, recording, and managing maintenance on equipment using appropriate forms and records.

a. The ULLS collects maintenance and supply data and provides management information at the unit level.  
b. The ULLS automates/replaces portions of TAMMS. Commanders ensure that portions of TAMMS not replaced by ULLS are accomplished using the procedures outlined in the pamphlet. The following DA and DD maintenance forms have been automated and ULLS-generated printouts (shown with a -E) are authorized replacements:

(1) *AWCMF452*. DD Form 314 can still be used (for example, arms room and nuclear, biological, chemical (NBC) room).

(2) *DA Form 5988-E*. This form replaces both DA Forms 2404 and 2408-14.

(3) *DA Form 5989-E (Maintenance Request Register)* and *DA Form 2405 (Maintenance Request Register)*.

(4) *DA Form 5990-E and DA Form 2407*.

c. The forms and records produced and recorded in ULLS-G are maintained by all units, organizations, and activities on all equipment that require maintenance to be performed in accordance with appropriate -10, -20, and -30 technical manuals and lube orders.

d. Units operating under ULLS use printouts or automated reports in place of the manual forms in other chapters. The automated processes in ULLS supercede all manual procedures. In cases where there is a conflict on form disposition, this pamphlet takes precedence.

e. There are four categories of maintenance processes within ULLS. This chapter contains information for—

(1) Maintenance operational processes.

(2) Equipment data update.

(3) Equipment data reports.

(4) Maintenance support.

f. SAMS for the DS/GS levels of maintenance provides maintenance and management information to each level of command from the user to the division or corps, wholesale, and DA levels.

g. SAMS is divided into two levels: SAMS-1, which operates at the DS/GS maintenance company; and SAMS-2, which operates at command levels above the maintenance company, such as the support battalion or maintenance battalion; materiel management center (MMC); division support command; corps support command; and echelon above corps.

(1) SAMS-1 tracks all work orders and repair parts, and processes information received from supported units.

(2) SAMS-2 collects, stores, and retrieves maintenance information from SAMS-1 sites and allows managers to coordinate maintenance workloads.

(3) SAMS-2 passes significant maintenance and supply information to LOGSA, where it is loaded into the logistics integrated data base (LIDB) Maintenance Module, formerly known as the Work Order Logistics File. SAMS-2 and SAMS-I/TDA sites must submit their closed work order data to LOGSA by the 10th of each month. Procedures are explained in the SAMS-2 and SAMS-I/TDA user manuals. The consistent reporting of these data is critical; the LIDB Maintenance Module is used to determine operation and support costs, velocity management performance, manpower studies, and other studies that affect units and equipment.

h. Unique SAMS forms are addressed in this chapter. DA Forms 5409 (Inoperative Equipment Report) and 5410 (Unit Level Deadlining Parts Report) feed the inoperative equipment process at the SAMS-2 level. SAMS applies the term inoperative equipment to a reportable or locally designated command maintenance significant item that is NMC (see para 3-6). The inoperative module in SAMS-2 is intended to provide readiness management capability within the division, echelon above division, and echelon above corps. It is not for compliance with DA/wholesale readiness reporting requirements. In other words, SAMS-2 inoperative reporting is not intended for reporting property book equipment shortages.

i. The examples show the results of inspections, tests, and maintenance performed. They also show the results in diagnostic checks and form the bond between maintenance and supply actions.



*j.* This chapter provides procedures and examples of automated forms and printouts from ULLS-G and SAMS and maintenance forms used by manual units.

(1) In addition to the forms within this chapter, maintenance forms for nonstandard air traffic control (ATC) and navigational aid (NAVAID) equipment, when specified in the equipments technical publications, are also maintained. Each designated form is maintained using guidance found within the appropriate technical publication. Examples of nonstandard equipment are—

- (2) Instrument landing system and all associated marker beacons.
- (3) Distance measuring equipment systems.
- (4) Airport Surveillance Radar Systems.
- (5) Automated Radar Terminal Systems.
- (6) Air Traffic Control Beacon Interrogator Systems.
- (7) Flight Data Input/Output Systems.
- (8) Digital Brite Radar Indicator Tower Equipment Systems.
- (9) Radar Video Mappers.
- (10) Programmable Indicator Data Processors.

### **3-2. Maintenance reporting and AMSS**

AR 700-138 governs maintenance reporting of equipment and systems. AMSS is designed to replace all manual materiel readiness reports for ground, aviation, and missile equipment. Units not using ULLS follow reporting instructions as outlined in AR 700-138.

*a.* AMSS was developed to automate the manual readiness reporting requirements listed in AR 700-138. AMSS replaces DA Form 2406 (Materiel Condition Status Report), DA Form 1352 (Army Aircraft Inventory, Status and Flying Time) and DA Form 3266-1 (Army Missile Material Readiness Report) with a single automated readiness reporting system. It is the commanders link to monitoring the maintenance and supply posture of the unit.

*b.* AMSS collects, compiles, and reports materiel readiness data at the unit and provides this information to the battalion level. The capability exists to consolidate the real time readiness information received from subordinate units and is used for the purpose of monitoring and reporting their readiness posture.

*c.* AMSS accumulates NMC data and parts information for all reportable end items, systems, and subsystems and has the capability to receive support and depot-level NMC data from the SAMS-1. NMC time due to an equipment shortage (NMCE) is not included in AMSS. The capability of maintaining authorized and on-hand data is included in AMSS.

*d.* The readiness information accumulated at the battalion level is provided to SAMS-2, where it is forwarded to LOGSA.

### **3-3. Maintenance control file (non-ULLS/manual input)**

*a.* Each non-ULLS customer unit sets up a maintenance control file in a visible index file to show the status of reportable equipment in the unit. Copies of current DA Form 5409 and 5410 go in this file.

(1) A recommended record-keeping system to make sure that DA Forms 5409 and 5410 are properly filled out and submitted is contained in DA PAM 750-35.

(2) ULLS automates this record keeping at the unit level.

*b.* DA Form 5409 goes in the maintenance control file in organization work order number (ORG WON) sequence. The oldest appears at the top of the file; the newest, at the bottom. As work requests are closed out, DA Form 5409 is removed and discarded.

*c.* Information in the maintenance control file is changed whenever a maintenance request status changes. A new DA Form 5409 is updated and filed on top of any previous DA Forms 5409 with the same ORG WON. DA Form 5409 is forwarded to SAMS-2 each day prior to the established cutoff when changes occur during that day.

*d.* DA Form 5410 showing status of an inoperative reportable item is filed in the maintenance control file under DA Form 5409 for that item.

*e.* Maintenance supervisors check the maintenance control file weekly to make sure that forms are thrown out as actions are completed and forms have been added for any new deficiencies. Supervisors also review forms on older, existing deficiencies to confirm the status and ensure that all possible actions have been taken to repair the equipment.

### **3-4. Organization work order number**

*a.* *ORG WON.* The ORG WON is assigned to all work orders for purposes of tracking inoperative equipment and all equipment sent to the support maintenance activity for repair. An ORG WON is the key to the inoperative equipment process.

*b.* *General instructions.*

(1) An ORG WON is assigned sequentially from DA Form 2405. Paragraph 3-11 gives details on the use of DA Form 2405.

(2) An ORG WON is assigned when reportable equipment listed in AR 700–138, or when a command maintenance-significant item designated by the local commander, become inoperative. An ORG WON is also assigned when a nonreportable subsystem of a reportable weapon system causes the weapon system to become inoperative. The positions of an ORG WON are as follows:

(a) The first five positions of an ORG WON are the UIC after the W. For example, a unit with a UIC of WABCD0 (zero) would use ABCD0 (zero) as the first five positions of each ORG WON. The letters I and O are not permitted in a UIC. Numeric 0 (zero) is authorized for use in a UIC.

(b) If the sixth position of the ORG WON has a zero (0) or a (1), it identifies ground or missile maintenance equipment, and whether it is reportable or not. A zero (0) identifies an end item as reportable under AR 700–138 or when list in the maintenance master data file (MMDF), or when a command maintenance-significant item, selected by a local commander, becomes inoperative. Also, zero (0) is assigned when a nonreportable subsystem of a reportable weapon system causes the weapon system to be inoperative. One (1) is used if the item of equipment is not reportable. Also, one (1) is used if a sixth position of the ORG WON has a two (2) or a three (3); it identifies aircraft maintenance equipment, and whether it is reportable or not. Two (2) identifies an end item as reportable under AR 700–138, or when a command maintenance-significant item, selected by a local commander, becomes inoperative. Also, two (2) is assigned when a nonreportable subsystem of a reportable weapon system causes the weapon system to be inoperative. Three (3) is used if the item of equipment is not reportable. Also, three (3) is used if a reportable item needs repair but is not inoperative; for example, if painting is needed.

(c) The seventh position of the ORG WON is the year within the decade. For example, the seventh position for each ORG WON assigned in 1992 would be two (2).

(d) The last five positions of the ORG WON are the sequence number of the work order. The sequence number is assigned at the unit maintenance platoon/section on DA Form 2405 for manual units.

(e) The first seven positions of the ORG WON stay the same during the year and are the same for each work order. The last five positions, however, are unique to each work order (for example, 0000199999 or HHC12).

c. *Special instructions.* An ORG WON must be assigned for all inoperative equipment, even if it is immediately evacuated to DS without any maintenance performed at the unit.

### **3–5. DA Form 5409 and DA Form 5410**

For units supported by ULLS, data collected on these forms are furnished to SAMS on an ULLS transaction diskette or via telecommunications (SAMS transactions, to include maintenance requests, equipment deficiencies, and inoperative organizational parts data). If any unit within a specific battalion, brigade, division, and so on, is not operating on ULLS, they submit DA Form 5409 and DA Form 5410 for all reportable equipment. All other assigned or attached units are restricted from submitting manual inoperative reporting forms. Use DA Form 5409 and DA Form 5410 to report deadlined or parts data, unless data are reduced at the SAMS–2 site.

#### *a. DA Form 5409.*

(1) *Purpose.* DA Form 5409 provides SAMS with the customer unit portion of the inoperative equipment data required to automate readiness management.

(2) *Use.* DA Form 5409 is used to report inoperative items that are reportable equipment identified in AR 700–138, including subsystems of reportable weapon systems, or command maintenance significant equipment that is designated by the local commander for special management. Units operating under the ULLS do not use DA Form 5409.

#### (3) *General instructions.*

(a) A DA Form 5409 is required whenever an item of equipment becomes NMC and meets the definition of an inoperative item in paragraph 3–1h. The form is prepared by the unit maintenance clerk and input to the supporting SAMS–2 site daily (figs 3–1, 3–2, 3–3).

(b) A DA Form 5409 can also be used when an inoperative item has a change in status at the customer level. However, if minimum input is desired, additional status may be limited to only significant changes (for example, when evacuated to DS for repair). Only blocks 1, 2, and 12a, b, and c are required for a status change on a DA Form 5409.

(c) So that SAMS–2 knows what to do with the information on the form, a File Input Action Code in block 1 is required. There are three action codes associated with DA Form 5409: A is used only when the item initially becomes inoperative; C is used to report changes in status for an inoperative item that has been reported, or for a controlled exchange action; and D is used to remove an inoperative item from deadline. When a DA Form 5409 IER with action code D is submitted, the associated part records for the inoperative item are also deleted in SAMS–2.

#### (4) *Disposition.*

(a) After entering information in blocks (11) through (21), a copy of DA Form 5409 is inserted in the visible file index with any previous ones.

(b) Local SOP establishes distribution of copies of this form. Individual copies of the form are not retained at unit level unless required for local use. Those copies, if required locally, are not maintained past the current MCSR reporting period.

#### *b. DA Form 5410.*

(1) *Purpose.* DA Form 5410 is used to identify/report parts that cause inoperative reportable equipment to be NMC-supply (NMCS).

(2) *Use.* DA Form 5410 is used—

(a) To track NMCS parts in SAMS.

(b) By SAMS-2 maintenance managers to target critical parts for intensive management. Units operating under the ULLS do not use DA Form 5410.

(c) To cross-reference a maintenance request with any deadlining part and to provide deadlining parts information to the MMC.

(3) *General instructions.*

(a) When inoperative equipment is NMCS, the first DA Form 5410 related to the deadlined part(s) should be submitted to SAMS-2 with DA Form 5409 reporting the deadline. If this is not the case, a DA Form 5410 must be submitted to SAMS-2 as soon as any deadlined parts are identified, but not on hand. An action code of A (fig 3-4) must be entered in block 1 of DA Form 5410. Leave block 6 blank.

(b) A DA Form 5410 is submitted with an action code of C in block 1 (fig 3-5), showing the new quantity on hand in block 6, when a partial or complete receipt occurs. Blocks 2, 3, 4, 5, 7, 8, 9, and 10 must also have entries.

(c) A DA Form 5410 with an action code of D is submitted when the quantity required for a particular part is canceled or no longer required. Only blocks 1, 2, 3, 8, 9, and 10 are required for submission of a DA Form 5410 with an action code of D (fig 3-6). If by satisfying the part requirement the equipment is no longer deadlined, the submission of DA Form 5409 with an action code of D, removing it from deadline, automatically deletes associated part records in SAMS for that item of equipment. All deadlining parts for one ORG WON must be entered on the same DA Form 5410, if possible.

(d) A DA Form 5410 with an action code of D can also be used to report complete receipt of parts, if the SAMS site agrees.

(4) *Disposition.*

(a) Forward the original copy of the form to SAMS-2.

(b) Forward the second copy to the battalion maintenance office.

### **3-6. ULLS to SAMS interfaces (unit using procedures)**

Unit-level activities with ULLS report maintenance information to SAMS. ULLS units run the SAMS-1 transaction process daily and send the information, via communications or diskettes, to their SAMS activity. Data from this process update the backside of DA Form 2406 (AHO003, AHO026) readiness information to their SAMS-2 managers. Reporting of maintenance information is accomplished by the following activities:

a. When ULLS is fielded to a company, maintenance and inoperative information is passed to SAMS utilizing an output process in ULLS.

b. Units without ULLS supported by a SAMS DS/GS activity report customer inoperative equipment data on DA Form 2406 for reportable/maintenance-significant items using DA Forms 5409 and 5410. These non-ULLS customers submit manual DA Forms 5409 and 5410 daily to their supporting SAMS-2.

c. Units complete the forms in accordance with this chapter for input only to SAMS-2.

d. Units without ULLS maintain a DA Form 2405 requesting support maintenance from DS/GS activities supported by SAMS.

e. ULLS creates two automated input files that are input to the SAMS-1 system:

(1) File ID AWAME125.Dat, which includes all work orders being evacuated to SAMS-1 and inoperative data from ULLS-A and ULLS-G systems.

(2) File ID AWAME130.Dat, which includes all AMSS input to SAMS.

f. SAMS-1 must provide ULLS-G timely automated status from its Work Order History program. Additionally, either SAMS-1 or SAMS-2 system must provide an equipment file to ULLS. This equipment file (the MMDF) originates from Army Materiel Command (AMC) LOGSA, Redstone Arsenal, AL. The equipment file (the MMDF) contains all reportable systems, subsystems, and nonreportable equipment.

g. For ULLS systems, a SAMS-1 Work Order Detail Report, PCN AHN018, is printed for the ULLS unit once the work request is closed (fig 3-7). Units maintain PCN AHN018 printouts for 180 days.

### **3-7. Equipment data reports**

The following functions provide hard copy reports:

a. *Parts received not installed.* There are two options in this process. The first is a print by admin number, and the second is a print by DODAAC. These reports list parts that have been received on the DCR but have not been installed through the parts install process (fig 3-8).

b. *Service schedule.* Provides a hard copy that shows the services by admin number, DODAAC, date range, or NSN (fig 3-9). (This process provides front side DD Form 314 data).

### 3-8. DA Form 2402 (Maintenance Tag)

a. *Purpose.* DA Form 2402 serves as an identification tag.

b. *Use.*

- (1) To identify items held for warranty claims.
- (2) To identify EIR exhibits.
- (3) As a receipt for TMDE items needing calibration.
- (4) To identify other items as needed.

c. *General instructions.* A separate DA Form 2402 is used for each item (fig 3-10). DA Form 2402 has four copies and is used as follows:

(1) Copy one is normally used as a unit receipt.

(2) Copy two is a receipt for the battalion level except for warranty claim items. When DA Form 2402 is used to identify or show action completed on a warranty item or claim exhibit, copy two is sent to the supporting warranty control office (WARCO). The WARCO uses DA Form 2402 to close out or complete any needed warranty actions or claims.

(3) Copy three serves as a receipt for support units.

(4) Copy four stays with the item until it is repaired and reissued. After repair is done, the tag identifies the item as fixed. This form is attached to each item sent to supporting maintenance shops (direct support (DS), general support (GS), depot, or a contractor for warranty repairs).

(5) Depending on the item, repair needed, and level of work, not all copies may be needed.

d. *Disposition.*

(1) DA Form 2402 is destroyed when the part or component it applies to is installed or disposed of.

(2) After the action is completed, copies used as a receipt are destroyed.

(3) When DA Form 2402 identifies a warranty claim or SF 368 (Product Quality Deficiency Report) exhibit, DA Form 2402 stays with the equipment until the item is no longer needed for a claim or exhibit.

### 3-9. DD Form 314

a. *Purpose.* DD Form 314 is a record of scheduled and performed unit maintenance including lubrication services, annual small arms weapons gauging, borescope and pullover gauging, and 180-day verification maintenance. It also records (NMC maintenance (NMCM)/NMCS) time; except for missile system/missile subsystem and FAA flight check data of ATC navigational aids.

b. *Use.* DD Form 314 is used for the following actions.

(1) *Schedule.* Periodic services on equipment, to include components in a system or subsystem, are scheduled when the technical manual requires a PMCS service to be performed by unit maintenance personnel. This form is also used to schedule the following services performed under the supervision of unit maintenance personnel:

(a) All nonoperator services are scheduled one service in advance.

(b) The next scheduled due date may fall in the following year. In that case, enter the date, miles, and hours due in the Remarks block until a new DD Form 314 is started.

(c) Weekends and holidays may be blocked out. When these are blocked out, services are scheduled on the next working day.

(d) The following symbols are used to show the type of service scheduled:

1. T—any test.
2. I—any inspection.
3. L—lubrication.
4. R—recoil exercise.
5. W—weekly service.
6. M—monthly (1 month) service.
7. Q—quarterly (3 months) service.
8. S—semiannual (6 months) service.
9. A—annual (1 year) (12 months) service.
10. E—18 months service.
11. B—biennial (2 years) service.
12. F—quadrennial (4 years) service.
13. H—tire rotation/inspection.
14. Z—oil sampling.

(e) The symbol L is used for all periodic lubes required by a lubrication order (LO). The interval block on an LO only tells when to schedule the lubes. It does not tell what services to schedule or symbol to use.

(f) Miles, kilometers, or hours between services are obtained from the TM and/or LO.

(g) Other symbols or subsymbols may be used as long as they do not conflict with the symbols required by this

pamphlet. Explain those symbols or subsymbols in the Remarks block of DD Form 314 or in the SOP. For example, may be used S1, SB2, or Lm, L5, L6, L12, or others might be used to show difficult services or manage the services pulled. Subsymbols should be scheduled to explain a service and lube pulled at the same time.

(h) To schedule a service, its symbol is written in pencil in the date due block with its miles, kilometers, or hours beside it. (Not all services will have miles or hour intervals.)

1. A service may not always be pulled when it is scheduled. So a 10 percent variance is provided before or after the scheduled day, miles, or hours. Within the variance, the service is treated as if it was done on the day/miles/hours schedule.

2. Some services cannot use the 10 percent variance because time is too critical. The TM PMCS table should always be checked before using the variance. For example, the MLRS is specifically NMC if the safety load test date has expired. The PMCS table always takes precedence over the 10 percent variance rule.

3. When the service is within the variance, ink in the symbol with the equipment's miles, kilometers, or hours on the date it was scheduled. When a service outside the variance is completed, erase the scheduled symbol and data, and ink in the symbol with data on the actual day the service was completed. Schedule the next service from the new date.

4. When the service exceeds the 10 percent variance, the equipment is administratively designated NMC until the next service is completed.

(i) Services vary the most when the LO requires a lube—

1. By hours, miles, or kilometers only. Enter the miles, kilometers, or hours when the next lube is due in the Remarks block. Ink in the symbol L and the hours, miles, or kilometers on the equipment in the block for the day the lube was performed.

2. On a date interval. Enter the symbol L on the date block the lube is due. Enter the miles, kilometers, or hours (when they apply) next to the symbol. When the lube is done, ink in the L and the miles or hours.

(2) *Documentation.* Show completed periodic services and lubes, by inking in the symbol or symbols and miles or hours. DD Forms 314 are tied to unit-level services and their intervals. The number of DD Forms 314 needed varies, based on the equipment and how and where maintenance is pulled. Normally, one DD Form 314 covers one piece of equipment. One DD Form 314 may cover several like items if the services are scheduled and pulled on the same date. Examples of like items are small arms and protective masks. When scheduling services on more than one item, enter each item's serial number in the Remarks block. Like equipment or subsystems, reportable under AR 700-138, cannot be combined on one DD Form 314.

(3) *Reporting.* NMC days are shown on equipment reported under AR 700-138.

(a) NMC time is kept on equipment that is reported under AR 700-138, tables B-1 and B-2, as a single item or as a subsystem.

(b) Equipment reportable under AR 700-138, tables B-1 and B-2, need a record of NMCM/NMCS time. NMC days on that equipment are kept on the reverse of DD Form 314 or on a separate DD Form 314 only when the equipment has a deficiency defined as NMC in the PMCS NOT MISSION CAPABLE IF column. Deficiencies not covered by the PMCS NOT MISSION CAPABLE IF column or equivalent carry a status symbol X or CIRCLED X, but NMC time is not counted for those deficiencies. Those deficiencies are carried on DA Form 2404.

(c) Unit NMCM days are shown with the symbol O. An S inside the O is entered for unit NMCS. Unit NMCM/NMCS days are posted as they occur. The letter X is used for each day the equipment is NMCM at support maintenance. The letter S is entered over an X on the days equipment was NMCS at support maintenance. If support does not provide a day-by-day breakout, the total number of support NMCM/NMCS days is used in the Remarks block. The front side of DD Form 314 is used to schedule services. The reverse side or another DD Form 314 is used to show NMCM/NMCS time.

(d) Support maintenance indicates which or how many days were NMCM/NMCS on the completed DA Form 2407 or a SAMS printout. This time is posted to DD Form 314. NMC time on equipment still in support maintenance at the end of a report period is provided to the owning unit by telephone or other local means.

(e) For NMC time, equipment that is NMC at the end of the day is counted NMC for the whole day. Equipment that is fully mission capable at the end of the day is counted as FMC for the whole day. A day is the normal workday for a command (see AR 700-138, chapter 4, for missiles).

(f) When equipment is loaned to another unit or activity, a copy of DD Form 314 goes with the equipment. The borrowing unit reports NMCM/NMCS time on the equipment. This information is also given to the owning unit at the end of the reporting period and when the equipment is returned.

(g) NMC time is posted on a separate DD Form 314 for each subsystem specifically identified in AR 700-138, tables B-1 and B-2. Another separate DD Form 314 is kept on the overall system, which is the system card. The system DD Form 314 shows the NMCM/NMCS time on the combined system.

(4) *AOAP instructions.* Scheduling oil samples on DD Form 314 is optional when the lab provides a printout that lists when the next sample is due. Oil samples are scheduled in pencil on DD Form 314. When the sample is taken the symbol and hours are erased from DD Form 314 and the next sample is scheduled in pencil.

(5) *Local guidelines.* Maintenance, services, or inspections are managed locally as directed by the unit commander.

This can include services performed by other echelons or units when the commander so directs. If a commander wants operator or crew services scheduled, they are entered in the Remarks block.

(6) *ATC documentation.* Document ATC required data should be documented as follows:

- (a) Within remarks section, exact PMCS technical references are shown, down to specific paragraph.
- (b) Within remarks section, normal time required for each PMCS interval is shown.
- (c) Within remarks section, date of last flight check of navigational aid is shown.

(7) *Prohibitions.* DD Form 314 is NOT USED for—

- (a) Periodic services designated for the operator or crew.
- (b) Showing oil samples taken.
- (c) Training aids and devices (equipment used ONLY for training). Small arms/weapons must be classified as unusable per AR 190-11 before they can be considered training aids.

(d) Equipment provided with an ADP printout or automated forms that list DD Form 314 data such as ULLS.

(e) Unit services on TMDE when the operators perform the services without supervision by unit maintenance personnel.

(f) Record NMC time for missile system/missile subsystem per AR 700-138, chapter 4.

(8) *General instructions.* Table 3-1 and figures 3-11 through 3-23 are used when determining the type of DD Form 314 required.

(a) Army equipment is divided into three categories for the purpose of filling out DD Form 314s. Equipment listed in AR 700-138, tables B-1 and B-2, represent the first two categories, respectively. Both are reportable. The third category is equipment that requires service data only as determined by the applicable technical manual but is not a reportable item, as outlined in AR 700-138, appendix B.

(b) Army equipment is further defined as a system, subsystem, equipment end item, or a component. A system is a group of items separately authorized on a modification table of organization and equipment (MTOE) or TDA that forms a single operational unit. A subsystem is a separately authorized item issued or intended to work with other items to form an operational unit. An equip end item is a separately authorized item issued or intended to work independently but is not reportable. A component is an item that is an integral part of a system, a subsystem or an equip end item and is not authorized separately. A component may have a LIN and requires services as outlined in a technical manual. The technical manual determines when to do a component DD Form 314. If the TM combines the services for all components, a component card is not required. Services are annotated on the front side of the respective DD Form 314. If the TM does not combine all component services, then a separate card is prepared for each component using its appropriate service schedule from its responsible TM.

**Table 3-1**  
**DD Form 314 requirements**

Item	Reportable B1 (table B-1)*	Reportable B2 (table B-2)*	Nonreportable (NR)
<b>System</b>	NMC data	NMC/service data	
<b>Sub-system</b>	NMC/service data	NMC service data	Service data
<b>Equipment end item</b>		Service data	Service data
<b>Component</b>	Service data	Service data	Service data

Notes:

\* From AR 700-138.

(9) *Special instructions.* Use a signal system to show when a service is scheduled in the current month. A month can be from the first day to the last day of the month (for example, 1 May through 31 May), or from a day in one month to the same day in the next month (for example, 13 September to 13 October). At the start of each month, enter signals (for example, colored paper clips) on the date blocks for the service. When the service is pulled; take the signal off the card or move it from the date block to one corner. Use the following signals.

(a) Green signal indicates a lube (L) is needed.

(b) Yellow signal indicates a T, I, R, W, M, Q, S, A, B, H, E, F, Z, or other service is due.

(c) Red signal is inserted over the right corner of the card when equipment is NMC. For equipment reported as a system in AR 700-138, table B-2, the red signal only is used on the system card. The signal is reused when the equipment is fixed.

(10) *Low usage instructions.* Handle low usage as follows:

(a) *Definition.* Services for equipment that accumulates or is anticipated to accumulate less than the specific

mileage/kilometers or hours in a 12-month period may have all unit (-20) and direct support services (-34) extended (see (3) below for low-usage criteria).

*(b) Use.*

1. Prior to placing equipment into low usage, all scheduled services and lubrication listed in the equipments -20 and -34 TMs/LOs (W, M, Q, S, A, E, B) is performed. Equipment requiring an E—18-month service and B—biennial (2 years) service is performed in accordance with the appropriate TM/LO at regularly scheduled service intervals, using the E or B symbol. After equipment is placed in the low-usage program, all services and lubrications, except the E and B, are combined with the annual services using the A symbol on DD Form 314. The date, miles/kilometers, and hours are entered in the Remarks block of DD Form 314 when equipment is entered in the low-usage program.

2. Equipment that exceeds the specified criteria at any time during the 12-month period immediately returns to scheduled servicing at normal TM/LO intervals, to be scheduled from the information that was entered in the Remarks block of DD Form 314.

3. Servicing, evaluating, and exercising of recoil mechanisms and tubes are accomplished in accordance with applicable technical bulletins and manuals.

4. All communications equipment/subsystems mounted or not mounted and equipment/subsystems mounted in shelters are serviced annually with the primary system.

5. Low-usage servicing is not utilized for equipment under warranty, armament equipment and equilibrating systems, ATC, and fire control components of combat vehicles and missile systems.

6. Operator/crew level (-10) maintenance intervals in TMs/LOs are not changed because of low usage.

7. AOAP is not extended; see chapter 4.

*(c) Vehicle storage.* When a vehicle is stored in Army Prepositioned Stocks or low usage, no AOAP sampling is required until the vehicle is scheduled for operational use.

*(d) AOAP sampling.* For units (-20 and -34) scheduled services (B Biennial), equipment has engine oil and transmission fluid (enrolled in AOAP) sampled prior to operation or the changing of any oil/lubricants. This sample helps determine the condition of oil/lubricants prior to operating equipment. Oil analysis is also performed during each annual maintenance cycle and immediately upon removing the vehicle from war reserve or low-usage program. Once the equipment returns to normal operation, sampling intervals established in chapter 4 apply. Vehicles in low usage that require a B service on differentials or gearbox are checked for contamination. If contamination exists, these components are drained, flushed, and refilled to the full mark.

*(e) Criteria.*

1. Light tactical vehicles, trailers assigned to prime movers, and trailers without assigned prime movers that accumulate or are anticipated to accumulate fewer than 3,000 miles/4,800 kilometers in a 12-month period.

2. Heavy tactical vehicles that accumulate fewer than 1,200 miles/1,935 kilometers in a 12-month period.

3. Combat vehicles (except armament, equilibrating system, and fire control components), missile systems (except fire control components), material handling equipment (MHE), and construction equipment anticipated to accumulate fewer than 500 miles/800 kilometers or 125 hours in a 12-month period.

4. Generators, pumps, air compressors, support equipment (reverse osmosis water purification units, bath units, and so on), watercraft, rail equipment, power-driven NBC equipment (for example, decontamination apparatus), engine-driven heaters, and air conditioners anticipated to accumulate fewer than 75 hours of operation in a 12-month period.

5. Communication equipment anticipated to accumulate fewer than 75 hours of operation in a 12-month period.

6. NBC equipment (for example, protective mask, M11 decon app, and so on) anticipated to accumulate fewer than 75 hours of use in a 12-month period.

7. Tentage and canvas items. Those not used are erected annually. Immersion heaters, mobile kitchen trailers, bakery ovens, field ranges and space heaters/stoves. Those not used are serviced annually.

8. Small arms and crew-served weapons (machine guns, mortars, and so on). Those maintained in a humidity-controlled room and not removed for any reason at any time during the year are serviced annually. All equipment, except that stated in 3-9b(10)(b)5, is inspected/operated/exercised by operators semiannually. Inspection/operate/exercise includes—

a. Perform all Before (B) through Monthly (M) PMCS checks per equipment operators TM.

b. Tactical (including trailers) and combat vehicles are to be driven at least 5 miles to insure their performance is within parameters listed in the operators TM. Vehicles equipped with radios have Before (B) through Monthly (M) PMCS performed per the communication equipment operators TM.

c. Construction, engineer, and material handling equipment, wreckers, and combat vehicles are operated sufficiently to ensure hydraulic systems reach normal operating temperature and equipment is mission capable.

d. Generators, air compressors, support equipment, pumps, and power-driven NBC equipment are operated for 30 minutes under load or 1 hour no load.

e. Small arms and crew served weapons are inspected, without leaving humidity-controlled room, for rust and corrosion. High-humidity area inspections may be required more often.

f. Visual inspections are performed by the operator/crew to ensure lubricant is present on all lubrication points.

- g. Visual inspections are used to identify, report, or remove any new corrosion that may have formed.
- (f) Low-usage criteria provide guidance and do not relieve commanders of their responsibility for adequate maintenance of their equipment while in storage.

*c. Disposition.*

- (1) DD Form 314 is used for 1 year for equipment reported under AR 700-138. It can be used for 2 years on nonreportable equipment.
- (2) The completed form is destroyed after transferring needed information to a new form. Transfer all information from these blocks:
  - (a) Registration number.
  - (b) Administration number.
  - (c) Nomenclature.
  - (d) Model.
  - (e) Assigned to.
- (f) Remarks: NMCM/NMCS data for the current report; hour meter or odometer change information; symbols; and any other needed maintenance data.
- (3) Any services needed should be scheduled in pencil.
- (4) The current DD Form 314 is with the equipment when it is transferred, but the losing unit keeps a record of NMCM/NMCS time for the current report period up to the day the equipment is dropped from the property book. The gaining unit reports the equipment's NMC at the time the item is added to their property book.
- (5) Destroy the DD Form 314 when the equipment is sent to salvage. However, the losing unit keeps a record of NMCM/NMCS time for the current report.
- (6) System DD Form 314 transfers any NMCM/NMCS data for the current reporting period to a new form. The old DD Form 314 is then destroyed.

**3-10. DA Form 5988-E and DA Form 2404 (Equipment Inspection and Maintenance Worksheet)**

*a. Purpose.* DA Form 5988-E and DA Form 2404 have four major purposes. This form is the central record for—

- (1) Faults found during an inspection. These faults include PMCS, maintenance activity inspections, diagnostic checks, and spot checks, except as noted in paragraph 3-10c.
- (2) Actions taken during unit/organizational level services for quality control.
- (3) Faults and repairs required for estimated cost of damage reports.
- (4) Battlefield damage assessment and repair (BDAR) performed.

*b. Use of DA Form 5988-E and DA Form 2404.* Personnel performing inspections, maintenance services, diagnostic checks, technical evaluations, marine condition surveys on watercraft, and PMCS use this form—

- (1) To inspect all components or subsystems that make up one equipment system. One DA Form 5988-E/DA Form 2404 or separate forms may be used for each subsystem (figs 3-24, 3-25).
- (2) To inspect several like items of equipment, for example one DA Form 2404 to inspect 25 M16A1 rifles (fig 3-26).
- (3) As a temporary record of required and completed maintenance.
- (4) To list faults that operators or crews cannot fix and list parts replaced.
- (5) During periodic services, unit maintenance lists all faults found and corrective action taken to fix faults. When used to inspect several like items, DA Form 2404 lists all deficiencies, shortcomings, and corrective action taken. If any items require support maintenance, a separate DA Form 2404 is completed and attached to a DA Form 2407 (figs 3-27, 3-28).
- (6) During initial inspection by support maintenance to list all faults found. The initial inspection is attached to DA Form 5988-E/DA Form 2404, is given to the person making the repairs. DA Form 5988-E/DA Form 2404 is used as the worksheet for correcting faults found and reporting any uncorrected unit level faults. Results of the maintenance action are entered on DA Form 5988-E/DA Form 2404.
- (7) During final inspection by support maintenance to list faults found. Attach the final inspection to the DA form 2407 that is given to the person who performed the repairs. The repairer corrects all faults found during the final inspection.
- (8) To collect all maintenance and services performed on equipment involved in a DA approved SDC plan. In addition to the requirements in this pamphlet, the applicable SDC Field Procedures Guide (FPG) may identify additional data required as mandatory entries on DA Form 5988-E/DA Form 2404.
- (9) To report battlefield damage repair and/or replacement actions by all personnel. AR 750-1 and the individual equipment battle damage technical manuals govern when and how battlefield damage repairs should be accomplished.

*c. Use FAA Form 6030-1 (Facility Maintenance Log) for recording PMCS results in lieu of DA Forms 5988-E/2404.*

*d. General instructions.*



- (1) Units using ULLS-G use the computer-generated DA Form 5988-E.
- (2) Operators and crews, first-line leaders, maintenance supervisors, and commanders are equally responsible for keeping information current and correct on DA Form 5988-E/DA Form 2404.
- (3) The way some blocks and columns on DA Form 5988-E/DA Form 2404 is filled out varies with form use. The instructions that apply to the use of the form must be carefully read.
- (4) When more than one DA Form 5988-E/DA Form 2404 is needed for an inspection or service, the page number is printed in the right side of the form's title block (1 of 2 on the first page and 2 of 2 on the second) and so on.
- (5) Parts on order or actions pending under anticipated NMC conditions are reflected on DA Form 5988-E and may go on DA Form 2408-14 with a diagonal status symbol.

*e. Use of status symbols.* Status symbols are used on automated and manual forms and records to show the seriousness of equipment faults or problems. The five status symbols used are X, CIRCLED X, HORIZONTAL DASH (-), DIAGONAL SLASH (/), and LAST NAME INITIAL.

(1) **X.** An X status symbol is for a fault or equipment condition that is a deficiency. Deficiencies put the equipment in an inoperative status. No one authorizes or orders equipment operated until the X condition is repaired or status is changed. If the condition is unusual and could occur on other similar equipment, check the other equipment. The commander or the commander's designated representative then immediately places all similar equipment in an X status. Each item is inspected. If the unsafe condition is found, it must be fixed and, if necessary, a Category I deficiency report is submitted, as outlined in chapter 10. Leave the equipment in an X status until instructions are received. An X status symbol applies to the following situations:

(a) *Deficiency on the equipment.* The motor officer, maintenance officer, or designated representative inspects all work taken to correct each status symbol X deficiency.

(b) *Component or assembly.* Defective or removed that makes the equipment unsafe to operate.

(c) *Equipment deficiency listed in the not mission capable if column (formerly equipment not ready/available if) of the equipment technical manuals (TMs) (preventive maintenance checks and services) (PMCS) table.*

(d) *Fault that endangers the lives of the operator or crew, listed in AR 385-55 as not mission capable (NMC), or that would further damage the equipment.* This equipment is not reported on the MCSR unless listed in the NMC column of PMCS tables, but is an administrative deadline with an "E" status in ULLS-G.

(e) *Emergency MWO published, but not applied to the equipment:*

1. Safety-of-use message issued stating a potentially dangerous or unsafe condition exists on the equipment.

2. Equipment judged by the commander as not able to do its mission.

(2) **CIRCLED X.** A CIRCLED X means the equipment has a deficiency but may be operated under set limitations (figs 3-29, 3-30). The commander or the commander's designated representative may authorize limited operation. The limited operation is usually for a one-time only operation but is dependent on the mission. A CIRCLED X status symbol applies to the following situations:

(a) *Urgent MWO or deficiency with limiting conditions on equipment.* Limited condition means the equipment can be operated, but only within limits set by the MWO or other publication. The limits may affect operation or require a maintenance action in a set time.

(b) *Potentially dangerous condition that requires limiting operations.* When this type of condition is found, other similar equipment should also be initiated. The commander or the commander's designated representative puts all similar equipment under limited operations. A Category I deficiency report as outlined in chapter 10 is submitted.

(3) **HORIZONTAL DASH (-).** A HORIZONTAL DASH shows that an inspection, service or routine MWO is due.

(4) **DIAGONAL SLASH (/).** A DIAGONAL SLASH shows a fault with equipment other than a deficiency. Faults must be fixed to make the equipment fully usable and to prevent more problems.

(5) **LAST NAME INITIAL.** The last name initial shows completely satisfactory condition or a corrected fault.

(6) *Status symbols reflect the judgment.* The status symbol reflects the judgment of the person making the inspection, operating the equipment, or doing the maintenance. No one orders an individual to change a status symbol. All changes become permanent, except CIRCLED X, until the fault is corrected or determined otherwise by the commander's designated representative, who is knowledgeable in maintenance. The faults are corrected per the Army -10 and -20 PMCS maintenance standards as noted in AR 750-1. A status symbol is changed only under the following conditions:

(a) *Status symbol change.* The commander or commander's designated representative ensures that the following is accomplished if there is a disagreement with a status symbol.

1. Changes can be made from a less serious to a more serious status symbol, and from a serious to a less serious status symbol.

2. The commander or commander's designated representative shows a status symbol change on a DA Form 5988-E/DA Form 2404 by re-entering the fault and new status symbol on the next open line. Status symbol change is written in column D next to the fault.

3. When either the original or final (change) status symbol is an X or a CIRCLED X, the repair work is inspected. When the repair is finished, whoever performed the work initials in column E. The commander or commander's

designated representative designates a qualified person who did not perform the repair work; this designated inspector puts a last name initial over the status symbol to accept the work and start the process to close out the fault.

(b) *Changing an X to a CIRCLED X status symbol.* A fault with an X status symbol puts the equipment in an inoperative condition. The equipment may have to be sent to a higher level maintenance activity for repair. Operating equipment in a CIRCLED X status symbol always carries some risk or danger. The commander or commander's designated representative verifies each deficiency on a daily or mission basis, whichever is more frequent.

1. Before allowing limited operations, make sure the crew or operators will not be endangered or the equipment further damaged.

2. A change to an X to a CIRCLED X is always temporary. When the daily or mission dispatch is over, the equipment goes back to an X status.

3. Changing an X NMC condition to a CIRCLED X affects only the operation of the equipment. The time is still counted as NMC on DA Form 2406 (Materiel Condition Status Report), DA Form 3266-1 (Army Missile Materiel Readiness Report), DD Form 314 (Preventive Maintenance Schedule and Record), and DA Form 3266-2 (Missile Materiel Condition Status Report Worksheet).

*f. Disposition.*

(1) DA Form 5988-E/DA Form 2404 is kept in the equipment record folder or in a protected cover until it is completed if no faults have been found. If faults are found during an operator or crews PMCS, it is given to the maintenance supervisor for action.

(a) Maintenance section leaders review DA Form 5988-E/DA Form 2404 prior to destruction to ensure all corrective actions have been completed.

(b) Faults that must be fixed at support maintenance are transferred to DA Form 2407 and attached to DA Forms 5988-E or 2404.

(c) Faults that cannot be fixed until a part comes in or that must be deferred are entered into ULLS or go on DA Form 2408-14 if using manual procedures.

(d) Status symbol X faults cannot go on DA Form 2408-14. When there is a NMC deficiency on DA Form 2404, it is kept until the deficiency has been repaired. This includes DA Form 2404 on equipment sent to support maintenance. The form or a locally used signal is kept in the equipment record folder to keep the equipment from being dispatched.

(2) DA Form 5988-E/DA Form 2404 used for scheduled services are kept on file for quality control until the next service is performed. All uncorrected faults are entered into ULLS-G, moved to DA Form 2408-14 or DA Form 2407, and the service recorded on DD Form 314. Forms carrying a status symbol X are kept until the fault is corrected.

(3) DA Forms 5988-E/2404 that show a periodic service on equipment that does not have historical records or a DD Form 314 are kept. DA Forms 5988E/2404 are destroyed only when the next periodic service is done. Any open faults at that time go on the new DA Forms 5988E/2404 unless a separate DA Form 2408-14 is used. This situation normally applies to the form used for services on more than one item or when an operator level service is required and must be documented. If the form lists no faults from previous service, the same form is used to show the results of the current service.

(4) DA Forms 5988-E/2404 used for technical inspections stay with the item until all maintenance is performed or item is disposed of. A copy of DA Form 2404 goes with an item evacuated to support maintenance units or depots for repair or overhaul.

(5) When the form has been used to report BDAR action (fig 3-31), DA Form 5988-E/DA Form 2404 are mailed to Survivability/Vulnerability Information Analysis Center (SURVIAC), ATTN: AFRL/VACS/SURVIAC, Wright-Patterson AFB, OH 45433.

(6) DA Form 2404 used for estimated cost of damage (ECOD) (figs 3-32, 3-33) is handled as follows:

(a) Two copies are attached to copy 4 of DA Form 2407 that requested the ECOD and returned to the requesting unit. The requesting unit with a DA Form 2407 returns a copy to request repair of the damage.

(b) A third copy is filled with copy 5 of DA Form 2407 at the maintenance support activity.

### **3-11. DA Form 5989-E/AHN007/DA Form 2405 (Maintenance Request Register)**

*a. Purpose.* DA Form 5989-E/AHN007/DA Form 2405 are used to record all work requests (DA Form 5990-E/DA Form 2407) received and handled by maintenance activities.

*b. Use.*

(1) Units supported by ULLS are not required to maintain a manual DA Form 2405, as it is automated within ULLS. The automated form, DA Form 5989-E (fig 3-34), provides a consolidation list of all open work orders and man-hours and work-order status.

(2) SAMS-1 automates DA Form 2405 at the DS/GS support maintenance activity and produces the AHN007 report. This report is used as a consolidated record of all maintenance requests (DA Form 5990-E/DA Form 2407) received.

(3) Manual units supported by a SAMS DS/GS maintenance activity use the manually prepared DA Form 2405 (fig 3-34) when assigning the ORG WON to DA Form 2407 for tracking organization work orders reflecting NMC

conditions for inoperative equipment. Routine maintenance requests (DA Form 2407) sent to support may also be recorded on DA form 2405.

(4) DA Form 2405—

(a) Is a maintenance management record at both unit and support levels.

(b) Is a ready source for information on maintenance requests. It also gives information for management reports (like backlog status reports, and so on).

(c) May be used (but is not required) at unit level as a record of maintenance requests sent to support activities for internal management.

(d) Is used by support activities to record and control DA Form 2407s sent and returned from commercial activities.

(5) Units review daily all open work orders with higher level support maintenance activity.

*c. Disposition.*

(1) DA Form 2405 is kept for 1 year after last date entered in column h.

(2) If used for making budgets or planning, it may be kept beyond 1 year until budget or plans are completed. It is then destroyed.

(3) Open work order numbers may be moved to a new register if DA Form 2405 is closed at the end of a calendar or fiscal year.

### **3-12. DA Form 3999-4 (Maintenance Work Request Envelope)**

*a. Use.* DA Form 3999-4 (fig 3-35)—

(1) Is used to store the forms required to record maintenance actions.

(2) Tracks the work order and the equipment location by entries on the face of the envelope each time the related equipment moves from one location to another.

*b. General instructions.*

(1) DA Form 3999-4 is a reusable envelope. The envelope has six preprinted blocks for posting a work order number and the applicable identification. Each block has four columns: Location, Section, Mechanic, and Date.

(2) Each section supervisor or repairer receiving the maintenance work request envelope signs for the envelope in the applicable block on the form. The last entry indicates the exact location of the equipment by bay, parking lot, or bin number.

(3) When the maintenance request has been closed, the block pertaining to that request is marked out and the next open block of the remaining blocks is used for a new maintenance request.

*c. Disposition.* Destroy the envelope when the current maintenance request on the envelope has been closed and all other blocks have been used.

### **3-13. DA Form 5990-E (Maintenance Request)**

This form serves as a request for maintenance support. ULLS automates DA Form 2407. Two hard copies of DA Form 5990-E (fig 3-36) and a DA Form 5988-E are generated by ULLS for delivery with the equipment to the support maintenance activity.

*a. Use.* DA Form 5990-E is used to—

(1) Request support maintenance, to include—

(a) Repairs not authorized at unit level.

(b) Application of MWOs.

(c) Fabrication or assembly of items.

(2) Report work on DA directed items under an approved sampling plan. AR 750-1 governs this program. The specific SDC FPG identifies data elements for the forms.

(3) Initiate work requests that may become warranty claim actions.

(4) Show all maintenance done on nontactical-wheeled vehicles, and tactical vehicles used as general purpose and passenger carrying vehicles. Use this form for vehicles and supported equipment when they are assigned to administrative equipment storage sites.

(5) Request an ECOD or technical inspection to classify the serviceability/reparability of an item before turn-in for replacement.

*b. Disposition.*

(1) One automated hard copy (copy #1) is used for accountability purposes and returned to support maintenance when the unit picks up equipment.

(2) A second automated hard copy (copy #2), stapled to a DA Form 2407 and/or DA Form 2407-1 (Maintenance Request—Continuation Sheet), is received with the equipment from support maintenance. The owning unit keeps this copy for 90 days after the equipment is fixed. For items under a DA approved sampling plan, hold this copy as directed by the plan.

(3) A SAMS-1 Work Order Detail Report, is printed by SAMS for the ULLS unit once the work request is closed.

(4) When used for BDAR, mail a copy of DA Form 5990-E to the Survivability/Vulnerability Information Analysis Center (SURVIAC), AFRL/VACS/SURVIAC, Wright Patterson AFB, OH 45433.

### 3-14. DA Forms 2407/2407-1

*a. Purpose.* DA Forms 2407/2407-1 serve as a request for maintenance support and give information to all levels of maintenance management. DA Forms 2407/2407-1 are the source of information for the Army's work order database at USAMC Logistics Support Activity (LOGSA). This database, called the Logistics Integrated Data Base (LIDB) Maintenance Module, formerly the Work Order Logistics File, provides statistical weapon analyses such as mean time to repair and repair parts usage at the DS/GS levels of maintenance for selected major weapon systems. Submit the maintenance request data to LOGSA through the Standard Army Maintenance System (SAMS) or SAMS-I/TDA monthly, as specified in this chapter and the SAMS-2 User Manual.

*b. Use.* Use DA Forms 2407/2407-1 as a maintenance request as follows:

(1) At the unit level, DA Forms 2407/2407-1 are used to—

(a) Request support maintenance (fig 3-37), to include the following:

1. Repairs beyond the units authorized capability or capacity.
2. Application of MWOs.
3. Fabrication or assembly of items.

(b) Report work on DA directed items under an approved sampling plan. AR 750-1 governs this program. The specific FPG identifies mandatory data elements for the forms.

(c) Initiate work requests that may become warranty claim actions.

(d) Show all support maintenance done on general purpose and passenger-carrying vehicles, combat vehicles, and tactical equipment.

(e) Request an estimated cost of damage (ECOD) or technical inspection to determine the serviceability/reparability of an item prior to repair or turn-in for replacement (fig 3-38).

(2) At support maintenance levels, these forms are used to—

(a) Record all work done and repair parts used, except common hardware and bulk material.

(b) Report all MWOs as they are applied as well as all previously applied MWOs.

(c) Send in warranty claim actions.

(d) Ask for repair components, assemblies, and subassemblies in the reparable exchange program. One form may be used for as many items under an NSN as needed. For example, one DA Form 2407 might cover 10 rifles or 5 starters or 30 carburetors.

(e) Ask for maintenance from another activity or supporting unit.

(f) Report work done on DA data sampling items under AR 750-1 and the specific FPG.

(g) Report battlefield repair actions. AR 750-1 and the individual equipment battlefield damage repair technical manuals govern how such repairs should be done.

(h) Serve as a dispatch record when road testing vehicle being repaired.

(i) Record support maintenance done under contract.

(j) Track serial numbered items within SAMS.

(3) At the depot level, these forms are used to—

(a) Report MWOs as they are applied as well as all previously applied MWOs.

(b) Send in warranty claim actions.

(c) Show onsite work done by depot personnel.

(d) Report repair and return to user work done.

(e) Report work done on DA data sampling items.

(f) Record depot maintenance done under contract.

*c. General instructions.*

(1) DA Forms 2407/2407-1 show the specific item(s) being sent to support maintenance as follows:

(a) A separate DA Form 2407 is filled out on each item reported under AR 700-138. A separate form is also filled out on each component of an item reported under AR 700-138, when submitted separately from the end item.

(b) Items with the same make, model, and NSN on a single DA Form 2407 are combined when they are not reported under AR 700-138. DA Form 2407-1 may be used when more room is needed.

(c) Items turned in for classification are on separate forms.

(2) A copy of DA Form 2408-5 (Equipment Modification Record) is sent with the equipment going to support maintenance. See figures E-1 through E-4 for listing of equipment that requires DA Form 2408-5.

(3) The organization asking for maintenance fills out Section I of DA Form 2407 and sends all copies of the form with the equipment.

(4) The support unit fills in blocks 2 through 4 and puts a local work order number on the form. Copy one then goes

back to the organization as a receipt for the equipment. The unit returns copy one when the equipment is fixed and ready for pickup.

(5) If parts needed for maintenance are not available when a maintenance request is made, the supporting unit may defer the maintenance, except NMC equipment, by printing in the Remarks block, "Equipment returned to user, awaiting parts (date)." Equipment owners are notified when parts are available. Support maintenance retains copy number 1 and the equipment owner retains all other copies. The unit returns the equipment and maintenance work request no later than the end of the following workday once being notified by support maintenance.

*d. Disposition.*

(1) *Receipt copy one.* Used for accountability purposes and returned to support maintenance when equipment is picked up by the unit.

(2) *NMP copy two.* Handle as directed by the local command. Retain for 180 days if copy is turned into supply support activity (SSA) or property book officer.

(3) *Control copy three.* Handle as directed by the local command. When the form is a facsimile, containing only copies one and two, such as those which are generated by an automated ULLS unit, the SAMS-1 system produces PCN AHN-018 (Work Order Detail Report) in lieu of copy three, if required, once the work request is closed. When the form is used for BDAR, mail this copy to the Survivability/Vulnerability Information Analysis Center (SURVIAC), ATTN: AFFDL/FES/CDIC, Wright Patterson AFB, OH 45433.

(4) *Organization copy four.*

(a) The owning unit keeps this copy for a minimum of 90 days after the equipment is fixed. For items under a DA approved sampling plan, hold this copy as directed by the plan. DA Forms 2407/2407-1 showing unit requested services (that is, calibration, test, scheduled services and/or inspections) may be kept until the next service is performed or data transferred to DD Form 314 or ULLS.

(b) When the form is used for ECOD, keep this copy as associated correspondence until released by the investigator at the completion of the investigation.

(c) Attach to DA Form 2765-1 (Request for Issue or Turn-In) for items turned into property book office or SSA.

(5) *File copy five.* The maintenance activity keeps this copy for 1 year after the owning unit accepts the equipment.

### **3-15. DA Forms 2407/2407-1 used to request or report an MWO**

*a. Purpose.* DA Forms 2407/2407-1 both request an MWO be applied and show MWOs done.

*b. Use.* DA Forms 2407/2407-1 is used to—

(1) Request that an MWO be applied (fig 3-39). Depot maintenance, or commercial contractors normally apply MWOs.

(2) Document applied MWOs on end items, installed components, and uninstalled components (fig 3-40).

(3) Document an MWO against an end item when a modified component replaces an unmodified one. Note that the responsible sponsoring agency ensures that equipment owners know when MWOs apply to their equipment. Report MWOs applied at depots as directed by AMC automated procedures. Depot teams and contractors applying MWOs in the field document applied MWOs on DA Forms 2407/2407-1 and report information into the Modification Management Information System (MMIS).

*c. General instructions.*

(1) The requesting unit sends all copies of DA Forms 2407/2407-1 to the activity that applies the MWO. The equipment normally does not go to that activity until MWO kits are on hand. If MWO kits are already on hand, the equipment goes with the form.

(2) When URGENT MWO kits are not on hand, the equipment normally goes to the maintenance activity with the form. A receipt copy is returned to the unit.

(3) For other than URGENT MWOs, the maintenance activity gets only the form until the kits arrive. The maintenance activity will print in the Remarks block, Receipt of MWO Request (Date) (Name or Initials), and return copies 2, 3, 4, and 5 to the unit. Keep copy one of DA Forms 2407/2407-1. When the MWO kits or parts come in, the unit asking for the MWO will be contacted. The unit will send the equipment and all copies of DA Forms 2407/2407-1 to the maintenance activity. The maintenance activity will fill in blocks 2 through 4 of DA Form 2407. The unit asking for the MWO will get copy one as a receipt. All other copies of the form stay with the support maintenance activity.

(4) When an applied MWO changes the NSN of the end item, send in a DA Form 2408-9 (see paragraph 5-7c(10)).

*d. Reporting.* Reporting MWOs accomplished and applicable to the same vehicle configuration can be listed by serial number on DA Form 2407-1.

*e. Disposition.* When the MWO has been applied—

(1) Destroy the receipt copy one when the equipment goes back to the owning unit.

(2) Send NMP copy two to the DA MWO sponsoring agency within 3 working days. The MWO publication identify the agency and address to use.

(3) Handle control copy three as directed by the MWO pub or Materiel Fielding Plan. Otherwise, handle as directed locally.

- (4) Destroy organization copy four.
- (5) Keep file copy five until the next MWO validation.

### **3-16. Warranty claim action**

*a. Purpose.* DA Forms 2407/2407-1 are the only forms used to file warranty claim actions (WCAs). Figure 3-41 shows how to prepare DA Form 2407 for WCAs.

*b. Use.*

(1) DA Form 2407 is used to send in WCAs for items with bad components, parts, or assemblies covered by a factory warranty. Do not use SF 368 to report warranty claims.

(2) All WCAs, settled or unsettled, are reported to the national level on DA Form 2407.

(a) Settled WCAs are for warranted items that have been repaired by organic maintenance units or by a local contractor/dealer.

(b) Unsettled WCAs are for warranted items awaiting disposition instructions or items being retrograded for repair at a higher level of maintenance or to a contractor facility.

*c. General instructions.*

(1) The Army's Warranty Program covers all items under warranty. Check the warranty technical bulletins (WTBs) and with the warranty control office (WARCO) for specific items under warranty. WARCOs and logistics assistance offices (LAOs) are listed in appendix C.

(2) AR 700-139 governs the warranty program. Headquarters (HQ) AMC, 9301 Chapek Road, Fort Belvoir, VA 22060-5527, manages the Army's Warranty Program. The commands/addresses in table 3-2 consolidate information for WARCOs and equipment under warranty. Items purchased after 1984 and some items prior to that time have technical bulletins that describe the actions required for the particular warranty and equipment.

(3) Submission of WCAs is mostly limited to GS and depot level, except when specifically required by the warranty technical bulletin (WTB).

(4) The WARCO normally operates from the GS, Directorate of Logistics, Directorate of Installation and Services, supporting maintenance battalion, division/corps, or theater maintenance management center.

(5) The WARCO at support maintenance levels acts as liaison between Army units and local contractors or dealers. The WARCO manages the warranty program at post, camps, or stations. The WARCO—

(a) Establishes local procedures to control WCAs.

(b) Receives, verifies, administers, processes, and distributes WCAs.

(c) Handles local warranty claims that are completed by Army units or contractor dealer/service network.

(d) Acts as the point of contact for the AMC major subordinate commands (MSCs) that manage the equipment for the Army.

(e) Controls shipments of items for warranty work.

(f) Reports on WCAs.

(6) When WCAs reflecting local contractor/dealer repairs are completed, that is, all work has been accomplished, DA Form 2407 is marked Information Only and submitted to the MSC representative listed in table 32.

(7) If there is a disagreement between the Army and a local contractor/dealer/manufacturer over a warranty claim, the WARCO tries to resolve the problem at that level. When the disagreement cannot be resolved locally, the WARCO contacts the MSC representative listed in table 3-2. In overseas locations, the WARCO contacts the LAO for help in resolving warranty disputes.

(8) The WARCO must be aware that, when contractors or dealers perform warranty work, other work not covered by the warranty may be done as needed. The contractor or dealer expects to be paid for that work. The WARCO must stipulate, at the time of delivery, that either no nonwarranty work be done or be prepared to pay for the work.

(9) DA Form 2407 is the only form used to file warranty claim actions. No other forms are authorized as substitutes or replacements. The information listed in the blocks on DA Form 2407 are placed into the Deficiency Reporting System at the MSC to track particular warranties. Performance, part failure, and warranty cost effectiveness can be determined, just to list a few. It is very important that all the blocks shown in figure 3-42 be as accurate as possible. DA Form 2407 should list the end item in the header blocks (blocks 1-11). All WCAs are processed through the WARCO.

(10) Any component, part, or assembly under warranty that fails during the warranty period becomes a warranty claim exhibit. All exhibits carry a DA Form 2402 marked Warranty Exhibit. Exhibits are retained until disposition instructions are obtained. Normally, disposition instructions are in the supporting WTB. When the supporting WTB does not provide disposition instructions, the materiel manager provides disposition instructions within 30 calendar days after receiving the WCA.

(11) Warranty items evacuated under the Repairable Exchange Program have DA Form 2407, WCA, initiated prior to sending the item. The WCA is completed at the normal level of repair.

(12) Each AMC MSC publishes a WTB listing all equipment under warranty.

*d. Disposition.*

- (1) Copy one is kept by the owning unit until the equipment is returned or action is completed.
- (2) Copy two is sent to the address listed in table 3–2 for the items NSN.
- (3) Copy three is sent as directed by the WTB or with copy two. Copy three normally goes with copy two. A few WTBs, however, may require that copy three be sent to a separate location or at a different time when special or expedited parts support is needed.

(4) Copy four is returned to the owning unit or filed by the WARCO.

(5) Copy five stays with the item until the warranty action is completed; it is then destroyed.

*e. Addresses for WCAs.*

(1) WCAs on DA Forms 2407/2407–1 are sent to the addresses in table 3–2. These addresses are the screening points where all WCAs are to be sent regardless of who furnished the item.

(2) The screening point is identified in position on of the Materiel Category Structure Code (MATCAT) in the Army Master Data File (AMDF) for each NSN. If the MATCAT Code of the item using the AMDF cannot be found, use the items Federal Supply Class (the first four numbers of the NSN).

**Table 3–2  
Warranty claim addresses**

Command	Materiel category code	Federal Supply Category Number	Contact information
U.S. Army Aviation and Missile Command (AMCOM)	MAT CAT Position 1: L, H	FSC: 1280, 1336 <sup>1</sup> , 1340, 1337 <sup>2</sup> , 1338, 1410-1450, 1510-1730,1810-1850, 2810, 2840, 2845, 2915, 2925, 2935, 2945, 2995, 3110-3130, 4920, 4935, 4960, 5303, 5365, 6340, 6605, 6610, 6615, 6620, 6920, 8140. 9135	Commander U.S. Army, AMCOM, ATTN: AMSAM-MMC-MA-NM, Redstone Arsenal, AL 35898-5000 DODAAC: W81D17 Call or send message to: Voice: (256) 876-2256, Defense Switched Network (DSN) 746-2256 FAX(256) 876-4904 DSN 746-4904 Email: cfo@redstone.army.mil Send Message to: CDR AMCOM REDSTONE ARSENAL AL//AMSAM-MMC-MA-NM//
U.S. Army Research Development and Engineering Command-ARDEC(RDECOM-ARDEC)	MAT CAT Position 1: M	FSC: 1005-1055, 1090-1270, 1285-1330,1345-1398, 3405-3450, 3611, 3620, 3645,3650, 3660-3685,3690, 3693-3695,4921-4925, 4931-4933, 4940, 5220-5280,6650, 6665, 6920, 8140 1336	Commander, U.S. Army RDECOM-ARDEC ATTN: AMSRD-AAR-QEP-C Rock Island, IL 61299-7300 DODAAC: W91AS2 Call or send message to: Voice: (309) 782-7698 DSN 793-7698 FAX (309) 782-6653 DSN 793-6653 Email: qawqdrs@ria.army.mil Send message to: CDRRDECOM-ARDEC, ROCK ISLAND IL// AMSRD-AAR-QEP-C//
Joint Munitions Command (JMC)	MAT CAT Position 1: D	FSC: 1300-1399	Commander U.S. Army JMC ATTN: SFSJM-QAP Rock Island, IL 61299-6000 DODAAC: W52P1J Call or send message to Voice: (309) 782-6466 DSN 793-6466 FAX(309) 782-7341 DSN 793-7341 Email: margaret.johnson1@us.army.mil Send message to: CDR JMC ROCK ISLAND IL//SFSJM-QAP//
U.S. Army Communications-Electronics Command (CECOM)	MAT CAT Position 1:G, P, Q, U	FSC: 2596, 2598, 2691, 5450, 5805, 5811, 5815-6080, 6105, 6110, 6125-6145, 6605, 6615,6625, 6660, 6680, 6695-6780, 6920, 6940-7050, 7450,7550, 8130	Commander U.S. Army CECOM ATTN: AMSEL-LC-LEO-D-CS-CFO, Fort Monmouth, NJ 07703-5000 DODAAC: W15GK9 Call or send message to: Voice:(732) 532-4839 DSN 992-4839 FAX(732) 532-1413 DSN 992-1413 Email: cfo@cecom2.monmouth.army.mil Send message to:CDRCECOM FT MONMOUTH NJ//AMSEL-LC-LEO-D-CS-CFO//

**Table 3-2  
Warranty claim addresses—Continued**

Command	Materiel category code	Federal Supply Category Number	Contact information
U.S. Army Tank Automotive and Armaments Command (TACOM)	MAT CAT Position 1: K	FSC: 2310-2315, 2325-2340, 2410-2430, 2520, 2590, 2610, 2630-2805, 2815, 2910-2950, 3020,3040, 3110-3130, 3805, 3810, 3815, 3990 <sup>3</sup> , 4310, 5430, 3820 <sup>4</sup> , 3825, 3895, 3910, 3920, 3930, 3950, 2320 and 2350 (except SP artillery and antiaircraft guns)	Commander U.S. Army TACOM, 6501 East 11 Mile Road, ATTN: AMSTA-LC-LMIM/MS 419, Warren, MI 48397-5000 DODAAC: Call or send message to: Voice: (586) 574-7330 DSN 786-7330 FAX(586) 574-6323 DSN 786-6323 Email: tacomwarco@tacom.army.mil Send message to: CDR TACOM WARREN MI//AMSTA-LC-LMIM//

Notes:

<sup>1</sup> To determine correct address for particular NSNs under FSC 1336, check the AMDF for position 1 of the MATCAT. 1340 (except free rockets) 2320 and 2350 (SP artillery and antiaircraft guns only)

<sup>2</sup> If it is not clear where the report should go, send it to: Commander U.S. Army Materiel Command, HQ AMC, 9301 Chapek Road, Fort Belvoir, VA 22060-5527.

<sup>3</sup> Well-drilling equipment only.

<sup>4</sup> Cargo net only.

**3-17. DA Forms 2407 and 2407-1 (serial number tracking implementation within SAMS)**

*a. Background.* A new process was added to SAMS with System Change Package (SCP) L21-04-00 that meets the initial DA-directed requirements for reporting of critical/high dollar value components of selected end items associated with the M1, M1A1, M1IP, and M1A2 tanks. The purpose of the process is to capture maintenance actions performed on these items in the DS/GS SAMS-1 activities and forward them through SAMS-2 to LOGSA.

*b. Updating the SAMS files.* The SAMS-2 Equipment Master File (EMF) contains those DA-designated serial number tracking items as shown in table 3-3. The major end item NSN and its associated SNT component NSNs must be identified as SNT Y.

(1) Major end items NSNs and component NSNs required to be reported by serial number are listed in table 3-3.

(2) LOGSA is responsible for updating SNT items on the MMDF. The MMDF is downloaded from LOGSA through the SAMS-2 MMC system. ULLS in turn receives the MMDF from the SAMS.

*c. SAMS/SNT procedures.*

(1) When SAMS-1 receives a maintenance request for an SNT item, which may be the end item or the component, and the work involved based on the task record is associated with an SNT component, SAMS-1 enters data from the task record with the appropriate information, based on the maintenance action performed.

(2) DA Form 2407, block 25 (fig 3-42), is used to record SNT information. The information is annotated by the work center NCO/foreman and is updated by him or her prior to being turned into the production control clerk. Maintenance activities utilizing SAMS-1 ensures that all necessary data required is entered to record SNT data for the selected end items and components listed in table 3-3. If extra space is needed, use DA Form 2407-1 (fig 3-43).

**Table 3-3.  
List of SNT reportable items**

NSN	EIC	Equipment Category Code (ECC)	Nomenclature
2520-01-325-9834	N/A	FB	Transmission M1A1 and M1A2 w/ container and hangons
2520-01-207-3527	N/A	FB	Transmission M1A1 and M1A2 w/ o container and hangons
2520-01-325-9834	N/A	FB	Transmission M1IP w/ container and hangons
2520-01-207-3527	N/A	FB	Transmission M1IP w/o container and hangons
2520-01-465-4317	N/A	FB	Transmission (SEP) M1A2 w/ container
2835-01-269-1234	N/A	FB	Forward module M1A1, M1IP, and M1A2 w/ container



**Table 3-3.**  
**List of SNT reportable items—Continued**

NSN	EIC	Equipment Category Code (ECC)	Nomenclature
2835-01-178-7245	N/A	FB	Forward module M1A1, M1IP, and M1A2 w/ container
2835-01-408-7048	N/A	FB	Forward module M1A1, M1IP, and M1A2 w/ container
2835-01-178-7246	N/A	FB	Forward module M1A1, M1IP, and M1A2 w/ container
2835-01-197-8325	N/A	FB	AGB M1A1, M1IP, and M1A2 w/ container
2350-01-136-1095	AAB	FB	Tank combat FT M1A1
2350-01-136-8738	AAC	FB	Tank combat FT M1IP
2350-01-328-5964	AAF	FB	Tank combat 120MM M1A2

### 3-18. Reporting requirements

a. Serial number reporting is not required when a serviceable item is removed solely to aid other maintenance actions and the same serial numbered item is to be immediately reinstalled on the item from which it was removed.

b. Serial number reporting is required when a designated NSN in table 3-3 or the MMDF has a maintenance action taken on it. The following action codes are used when adding a task to a work order in SAMS:

- (1) A—Replaced.
- (2) C—Repaired.
- (3) H—Modification work order applied.
- (4) O—(Alpha) Overhauled.
- (5) R—Removed.
- (6) S—Installed.

### 3-19. DA Form 2408-14

a. *Purpose.* DA Form 2408-14 is a record of uncorrected faults and deferred maintenance actions on equipment. Deferred maintenance actions are authorized delays for repair or maintenance. Equipment with deferred maintenance does not meet the Army maintenance standard as addressed in AR 750-1.

b. *Use.*

(1) DA Form 2408-14 serves as a record of uncorrected faults and deferred maintenance—that is, an authorized delay for maintenance actions.

(2) Deferred or delayed maintenance can affect operation of the equipment, mission performance, and safety. Therefore, the commander or commander's designated representative determines when a fault is to be transcribed to DA Form 2408-14. Faults not requiring parts, or faults for which parts are on hand, are corrected without delay per AR 750-1. Status symbol X faults are not entered on DA Form 2408-14.

(3) DA Form 2408-14 is kept on any item or group of items that has an open deferred maintenance action. This form is not required when an automated system provides a list or printout of deferred maintenance and uncorrected faults that includes all elements on DA Form 2408-14.

(4) Units using ULLS do not use DA Form 2408-14.

c. *General instructions.*

(1) Maintenance status symbol HORIZONTAL DASH (-) and DIAGONAL SLASH (/) faults are annotated on DA Form 2408-14 (fig 3-44).

(2) When a deferred maintenance action exists on an item of equipment, DA Form 2408-14 is with the equipment when the equipment is undergoing maintenance, on dispatch, under operation, or undergoing a service or inspection.

(3) Separate forms are not required for items (except reportable subsystems) like rifles, protective masks, and M11 decon apparatus, when one DA Form 2404 has been used to inspect and record the status of those items. A single form may be used to show deferred faults on such items as long as each fault entry is preceded in column b by the items administration or serial number.

(4) Operators or crews check the form before each dispatch. Look for faults that may affect the mission and faults that are overdue to be fixed. For example, look at any dates in column c that have passed or actions that have already been taken. Tell the maintenance supervisor about any found.

(5) Maintenance supervisors and section leaders (platoon) review the forms periodically (not less than every 2 weeks for Active Army and 1 month for National Guard/Reserve Components). Check on the status of parts on order. Look for any faults that have been fixed, but not closed out. Check for any faults overdue to be fixed.

(6) The form is kept in the equipment record folder or in a protective cover when a deferred maintenance action or uncorrected fault exists on the item of equipment.

(7) Do not start a DA Form 2408–14 until there is an uncorrected equipment fault that cannot be corrected due to lack of repair parts or deferred action.

(8) A second copy of DA form 2408–14 may be kept wherever and whenever needed for maintenance supervisors or section leaders.

(9) Parts on order or actions pending under ANMC conditions may go on the form with a DIAGONAL SLASH status symbol. Line out the entry if the ANMC condition changes to an NMC condition. The status symbol for the NMC condition then changes to an X and the entry can no longer stay on the form. Enter the NMC condition on the current DA Form 2404.

*d. Disposition.* Destroy DA Form 2408–14 after the form has been filled up and all the faults have been fixed or moved to a new DA Form 2408–14.

### **3–20. FAA Form 6030–1**

*a. Purpose.* FAA Form 6030–1 is a record of all maintenance actions performed at any ATC facility and/or navigational aid. Federal regulatory guidance can be found in Department of Transportation (DOT) Federal Aviation Administration (FAA) Order 6000.15C.

*b. Use.*

(1) FAA Form 6030–1 provides a complete record of all maintenance actions performed at any ATC facility and/or navigational aid. It logs document equipment performance and maintenance activities, as well as provides a historical record of site events.

(2) An FAA Form 6030–1 is maintained at each navigational aid or ATC equipment area.

(3) One FAA Form 6030–1 may be used to cover all ATC equipment at one specific tactical site.

(4) FAA Form 6030–1 is used instead of DA Form 2404 for recording unit preventive maintenance checks and services. Clearly annotate PMCS.

*c. Log instructions.*

(1) *Basic log format.* Log entries must be accurate, complete, clear, and concise. The log documents fact, as perceived by the person making the entry. Elaborate detail or opinion are to be avoided. The use of approved contractions and reference to substantive records and directives should be used when describing maintenance activities. The FAA prescribes references that provide approved word and phrase contractions:

(a) *Legible entries.* All entries will be made in ink. All information noted must correlate with related data on other forms, records, and reports. Maintenance activities logged cite the appropriate technical reference needed to support the entry as a complete, understandable statement.

(b) *Location of logs.* Logs must be kept in the immediate vicinity of the log subject. Exceptions are allowed where this is impractical, but the location is designated within the maintenance standard operating procedures.

(2) *Log correction.* There must be no erasures or deletions of any entered data. A corrected entry is mandatory for erroneous entries relating to a facility interruption. Errors are corrected by one of the following two methods:

(a) The person making the error can void the entry with a single line strikeout, followed by their initials and the corrected version. This method is only used when the correction can be entered adjacent to or immediately below the erroneous entry.

(b) An entry in error is corrected with an additional entry referenced to the erroneous entry by date and time. The person making the correction then notes the date and time of the corrected entry and initials in the margin adjacent to the erroneous entry.

(3) *Activities requiring log entries.* Entries in the logs provide a complete accounting of activities related to facility status, certification, operation, or performance. Entries include but are not limited to—

(a) Physical arrivals and departures at facilities without permanent staff. At least one entry includes the purpose of the visit, if not apparent from other entries.

(b) All system and subsystem interruptions and related activities.

(c) Start and completion of PMCS or corrective maintenance actions performed.

(d) Identification of failed or replaced equipment components by reference designation, part number, NSN, or serial number.

(e) Start and completion of flight inspections (where onsite personnel are involved or notified), technical inspections, and aircraft accident investigations.

(f) Technical evaluations, inspections of any kind, and aircraft/incident investigations.

(g) Equipment changes or replacement or adjustment of parameters.

(h) Modification, commissioning, or decommissioning activities.

(i) Pilferage, vandalism, or related events.

(j) Adverse weather effects, commercial power failures, access road problems, or any other conditions deemed to have impact on facility or air traffic operations.

- (k) Certification or decertification of systems, subsystems or services.
- (l) Visits by regional, headquarters, or non-FAA personnel.
- (m) Coordination entries concerning facility transfer, intentional channel changes, interruption, refusal and interruption request, or restoration shall state the organizational element and initials of the person contacted.
- (n) Supervisory log reviews.
- (o) Start and completion of radio frequency investigation if on site personnel about facility operations.
- (4) *Initials.* The originator initials the entry in the area provided on the last line of the entry. Two-party entries are initialed by the originator's initials on top, a slash (/), and the second party's (observer or second technician) initials under the slash in the initial box.
- (5) *Page numbering.* All serialized log pages remain in numerical order with any exceptions noted. When starting a new log, the serial number of the last page of the old log is referenced in the first entry of the new log. The serial number of the first page in the new log is referenced in the last entry of the old log or in the lower right margin of the last page.
- (6) *Month and year.* The month and year corresponding to the beginning entry on each page of the log are entered in the month and year block at the top of each page of the log.
- (7) *Date and time.* All entries are referenced to date and local time. Consecutive entries on the same calendar date need not be dated at each entry, but the date is required on the first and last entry of each page. Entries continued from the previous page need not have a date and time on the continued portion.
- (8) *Initial/final remarks entries.* Begin a new page with each calendar month. On the first line enter First Entry Month of (month). After last entry of each month, state Last Entry Month of (month). Draw a slash (/) through all unused lines.
- (9) *Technicians signature.* At the end of each month, the technician having the primary responsibility for the maintenance of the facility or navigational aid covered by the log is responsible for reviewing and signing the log page(s) in the lower right hand corner under Signature of Maintenance Technician.
- (10) *Supervisor's signature.* The maintenance supervisor conducts an onsite log overview prior to removal of the white page(s). Addresses and log procedural or policy discrepancies, technical completeness, detection of facility performance trends, and recurring malfunctions are reviewed. Mistakes or unclear entries are corrected by an additional entry referenced to the erroneous entry by date and time. After verifying that the yellow copy is a reproduction of the white page, the supervisor dates and signs the lower left block at the bottom of each page reviewed. The white page(s) are removed for filing at the maintenance office.

*d. Disposition.*

- (1) Facility maintenance logs are retained on file a minimum of 2 years and a maximum of 3 years from date of last monthly entry, or until no longer needed; destruction after 2 years is preferred. All log entries must be destroyed after 3 years.
- (2) Classified logs shall be transferred to the regional office or higher headquarters for destruction in accordance with FAA Order 1600.2.

### **3-21. Manager reports**

Manager reports provide the tools necessary for commanders and supervisors to effectively manage the units prescribed load list (PLL) and maintenance operations. AISM-25-L3Q-AWA-ZZZ-CG provides more detailed information on reports, internal SOP, and an ULLS checklist.

*a. Commander's Exception Report.* This report provides a listing of all urgency need designation (UND) A/B requests or items with an extended value of \$500 or more that have been processed since the last time the Commanders Exception Report was printed (fig 3-45). This report is initialed and signed by the commander prior to submitting the transaction. Retain this report for 2 years.

*b. Service Schedule Due.* This report provides a report of scheduled services due by administrative number, DODAAC, date range, or NSN (fig 3-46). Review this report monthly and dispose of it when no longer need or per local SOP.

(1) Use this report to determine which equipment requires services by admin number, DODAAC, date, or during a particular date range.

(2) To find services that are overdue, use a start date of 1 year prior to the current date and use the current date as the end date. The process lists all services not performed for the past year.

*c. Commander's Financial Transaction Listing.* This report shows ALL transactions during the ULLS to Standard Army Retail Supply System interface process and is reviewed before the daily transactions are sent to the direct support unit (DSU) (fig 3-47). Any request not approved can be canceled before transactions are sent to the DSU.

### **3-22. Selected SAMS output reports**

SAMS provides various output reports, as shown below, providing maintenance management information for all levels. Some of these reports are contained in the figures below.

a. SAMS-1 Customer Work Order Reconciliation, PCN AHN-004.

(1) This reconciliation report verifies that the equipment listed is physically in the possession of the supporting maintenance activity (fig 3-48).

(2) The report should be provided to the non-ULLS unit on a weekly basis.

b. SAMS-2 Equipment Deadlined Over NNN Days by Battalion, PCN AHO-026.

(1) This report provides a list of WOs that are more than a specified number of days old (NNN). The SAMS-2 manager when requesting the report enters the specified number of days (fig 3-49).

(2) This report is divided into three parts: Part I lists all DA Form 2406 reportable items on deadline; Part II lists all command maintenance-significant items on deadline; and Part III is a summary of the complete report, which lists the Parent UIC and name, reportable items, ERC A, pacing items, maintenance-significant items, and gives a command total within each area per battalion.

(3) When the number of days (NNN) is set to 00 (or blank), the report is a current reverse side DA Form 2406.

c. SAMS-2 Work Order Status and Parts Listing, PCN AHO-032.

(1) The Work Order Status and Parts Listing Report is selective by UIC (support or unit), WO status, and ECC or EIC for open work orders which, by priority, exceed the number of days set when requesting the report (fig 3-50). This report also provides a listing of parts by WO or ECC for each EIC.

(2) Listing Information is sorted by support UIC or customer UIC, support ECC, or work order number (WON).

d. SAMS-2 Maintenance Cost by Customer, PCN AHO-022.

(1) This report is produced to provide the customer with an exact cost for the repair of unit equipment by WON when SAMS-1 master files are completed with current labor rates and parts costs (fig 3-51).

(2) Information is sorted in order by UIC support, UIC customer, and WON.

INOPERATIVE EQUIPMENT REPORT											
For use of this form, see DA PAM 750-8; the proponent agency is DCS, G-4.											
1. FILE INPUT ACT CD A	2. UNIT WORK ORDER NO. (ORG WON) ZECEA0900073			3. ID A	4. NSN OF DEADLINED ITEM 2320013719577						
5. SERIAL NUMBER OF DEADLINED ITEM 2475				6. MALFUNCTION DESCRIPTION WATER IN OIL							
7. ERC A	8. WS D/L Y	9. WPN SYS EIC BBN		10. SERIAL NUMBER OF WEAPON SYSTEM (WS SERIAL NO.) 2475			11. BUMPER NO./TAIL NO. HQ22				
12a. STATUS CODE C	b. ORDINAL DATE 99071	c. MILITARY TIME 1030	d. REPORTED BY JWX		e. DATE ENTERED AT SAMS SITE	f. TIME ENTERED	g. SAMS SITE REP INIT				
13. UNIT WORK ORDER NUMBER ZECEA0900073				14. PD 02	15. INSP	16. PARTS	17. WAITING SHOP	18. IN SHOP	19. AT SPT MAINT.	20. WAITING PICK UP	21. BUMPER NO./TAIL NO. HQ22

DA FORM 5409, AUG 2004

DA FORM 5409, APR 1987, IS OBSOLETE.

APD 1.00

Legend for Figure 3-1; completion instructions follow.

1. FILE INPUT ACT CD. File Input Action Code A for Addition of a New Inoperative Record.
2. UNIT WORK ORDER NO. (ORG WON). The ORG WON assigned from the unit DA Form 2405.
3. ID. A for NSN.
4. NSN OF DEADLINED ITEM. NSN for the inoperative item.

Figure 3-1. Sample DA Form 5409

5. SERIAL NUMBER OF DEADLINED ITEM. The serial number of the inoperative item.
6. MALFUNCTION DESCRIPTION. Brief description of the deadlining fault in 15 alpha/numeric characters or less.
7. ERC. ERC for the item. Codes A, B, C, P or a space. If a weapon system is inoperative, the ERC of the weapon system is entered. An ERC is assigned to each item in the MTOE. Pacing items are identified in AR 220-1, which governs the use and application of ERCs.
8. WS D/L. Is the item causing a weapon system to be inoperative (deadlined)? Weapon System Deadline Code, Y (Yes), or N (No) is entered.
9. WPN SYS EIC. The Weapon System End Item Code (EIC) for the weapon system is entered if it is reportable on the MCSR. AR 700-138 lists the equipment and their subsystems. It is left blank if block (8) WS D/L is N, WPN Sys EICs are also identified on the ULLS-G or Air Equipment Master File, which is output from SAMS-2.
10. SERIAL NUMBER OF WEAPON SYSTEM (WS SERIAL NO.). The serial number of the deadlined weapon system. Blank if an N is entered in block 8 (WS D/L).
11. BUMPER NO./TAIL NO. The bumper number, tail number, or administration number, if applicable.
- 12a. STATUS CODE. The current status code; valid status codes are: Code Description 1, Awaiting NMCS parts; B, In shop; C, Awaiting shop; I, Awaiting shop while awaiting parts; J, In shop awaiting NMCS parts; M, Evacuated NMCS; O, Awaiting evacuation.
- b. ORDINAL DATE. The ordinal date of the current status in block 12a.
- c. MILITARY TIME. The military time of day of the current status in block 12a.
- d. REPORTED BY. The person reporting the status information initials in this block. Note that if the IER is in a visible file, the ORG WON, priority designator (PD), and bumper number can be entered at the bottom. A signal tab can be used to identify the current status (blocks 15-20). If N is entered in block 8, blocks 9 and 10 are left blank. If Y is entered, blocks 9 and 10 must be completed.
- e, f, g. To be completed by the supporting DSU.
13. UNIT WORK ORDER NUMBER. Self-explanatory.
14. PD. Self-explanatory.
- 15-20. To be completed by the supporting DSU
21. BUMPER NO./TAIL NO. Self-explanatory.

Figure 3-1. Sample DA Form 5409

INOPERATIVE EQUIPMENT REPORT										
For use of this form, see DA PAM 750-8; the proponent agency is DCS, G-4.										
1. FILE INPUT ACT CD	2. UNIT WORK ORDER NO. (ORG WON)	3. ID	4. NSN OF DEADLINED ITEM							
C	ZECEA0900073									
5. SERIAL NUMBER OF DEADLINED ITEM					6. MALFUNCTION DESCRIPTION					
7. ERC	8. WS D/L	9. WPN SYS EIC	10. SERIAL NUMBER OF WEAPON SYSTEM (WS SERIAL NO.)				11. BUMPER NO./TAIL NO.			
12a. STATUS CODE	b. ORDINAL DATE	c. MILITARY TIME	d. REPORTED BY	e. DATE ENTERED AT SAMS SITE	f. TIME ENTERED	g. SAMS SITE REP INIT				
B	99072	1230	JWZ							
13. UNIT WORK ORDER NUMBER			14. PD	15. INSP	16. PARTS	17. WAITING SHOP	18. IN SHOP	19. AT SPT MAINT.	20. WAITING PICK UP	21. BUMPER NO./TAIL NO.
ZECEA0900073										HQ22

DA FORM 5409, AUG 2004

DA FORM 5409, APR 1987, IS OBSOLETE.

APD 1.00

Legend for Figure 3-2;

completion instructions follow.

1. FILE INPUT ACT CD. File Input Action Code C for Change to previous input; status changes, corrections, or controlled exchange.
2. UNIT WORK ORDER NO. (ORG WON). The ORG WON of the work order that the status update applies to.
- BLOCKS 3-11. Leave blank.

Figure 3-2. Sample DA Form 5409 (change)

- 12a. STATUS CODE. Update status. Valid status codes are: Code Description 1, Awaiting NMCS Parts; B, In Shop C Awaiting shop; I, Awaiting shop while awaiting parts; J, In shop awaiting NMCS parts; M, Evacuated NMCS; O, Awaiting Evacuation.
- b. ORDINAL DATE. Ordinal date of the update status.
- c. MILITARY TIME. Military time of day of the update status entered in block 12a.
- d. REPORTED BY. The person reporting the status information initials in this block. Note that if the IER is in a visible file, the ORG WON, PD, and bumper number are entered at the bottom. A signal tab is then used to identify the current status (blocks 15–20).
- e, f, g. To be completed by the supporting DSU.
13. UNIT WORK ORDER NUMBER. Self-explanatory.
14. PD. Self-explanatory.
- 15–20. To be completed by the supporting DSU.
21. BUMPER NO./TAIL NO. Self-explanatory.

Figure 3–2. Sample DA Form 5409 (change)

INOPERATIVE EQUIPMENT REPORT										
For use of this form, see DA PAM 750-8; the proponent agency is DCS, G-4.										
1. FILE INPUT ACT CD	2. UNIT WORK ORDER NO. (ORG WON)				3. ID	4. NSN OF DEADLINED ITEM				
D	ZECCA0900073									
5. SERIAL NUMBER OF DEADLINED ITEM					6. MALFUNCTION DESCRIPTION					
7. ERC	8. WS D/L	9. WPN SYS EIC	10. SERIAL NUMBER OF WEAPON SYSTEM (WS SERIAL NO.)			11. BUMPER NO./TAIL NO.				
12a. STATUS CODE	b. ORDINAL DATE	c. MILITARY TIME	d. REPORTED BY		e. DATE ENTERED AT SAMS SITE	f. TIME ENTERED	g. SAMS SITE REP INIT			
			JWX							
13. UNIT WORK ORDER NUMBER			14. PD	15. INSP	16. PARTS	17. WAITING SHOP	18. IN SHOP	19. AT SPT MAINT.	20. WAITING PICK UP	21. BUMPER NO./TAIL NO.

DA FORM 5409, AUG 2004

DA FORM 5409, APR 1987, IS OBSOLETE.

APD 1.00

Legend for Figure 3–3;  
completion instructions follow.

1. FILE INPUT ACT CD. File Input Action Code D for Deletion/Closeout of an inoperative record.
2. UNIT WORK ORDER NO. (ORG WON). The ORG WON of the work order that the delete applies to.
- d. REPORTED BY. The person reporting the status information signs in this block. Note that if the IER is in a visible file, the ORG WON, PD and bumper number are entered at the bottom. A signal tab is then used to identify the current status (blocks 15–20). This input also deletes all associated part records. DA Form 5410 Deletes are NOT submitted.

Figure 3–3. Sample DA Form 5409 (deletion/closeout)









- 5. QTY RQD. Leave blank.
- 6. QTY REC/OH. Leave blank.
- 7. PD. Leave blank.

UNIT DOCUMENT NUMBER. Enter the document number (DODAAC, Julian date, serial number) from the part request if the part is being requisitioned from the SSA or other source requiring a Document Number. Enter a partial document number (DODAAC and Julian date) only if a document number has not been used.

- 8. DODAAC. Enter the DODAAC.
- 9. JULIAN DATE. Enter the Julian date.

10. SERIAL NUMBER. Enter the serial number (if applicable).

SAMS REP INIT. The SAMS-2 clerk initials this block after the data has been entered into SAMS-2.

**Figure 3-6. Sample DA Form 5410 (delete)**

```

PREPARED 13 SEP 02                                SAMS-1 WORK ORDER DETAIL                                PCN AHN-018

WORK ORDER DATA:
WON          UIC CUST  INTNS  REIMB  SHOP  SAMS-2 UIC  UTIL  TYPE MNT  ID AND NSN          MODEL OR NOUN
H0KB0A200047 WEZKD0    N      N      G      WH0KAA    0      A      A  5855012280937    ANEVS7B
ORG WON/DOC   SERIAL NUMBER  ECC  EIC  QTY REC  PD MALFUNCTION  FDD  EQUIP USAGE  PROJ CD  SNT  AFC
EZKD01202422 94352A          IPS      1  02 BENT OBJECTIVE F  A      000000
                                                000000
                                                000000

ORF AUTH  WRNTY  BUMPER NO  LVL WORK  MH PROJ  MH EXP  MH RMN  QTY RPR  QTY CONDEM  QTY NRTS  EVAC WON  ORF TRANS
                F      1.0    0.5    0.0    1      0      0      0      0      0      L

*****
WON          MIL DIRECT LABOR      CIV DIRECT LABOR      TOTAL DIRECT      INDIRECT      REPAIR PARTS      TOTAL COST OF
MH           MH           COST           MH           COST           LABOR COST           LABOR COST           COST           MAINTENANCE
H0KB0A200047 0.5          $8.11          0.0          $0.00          $8.11          $4.06          $256.00          $268.17
TOTALS       0.5          $8.11          0.0          $0.00          $8.11          $4.06          $256.00          $268.17
*****

TASK DATA:          * * * P L A N N E D   D A T A   * * *          * * * C O M P L E T E D   D A T A   * * *
TASK ACT TASK DESCRIPTION  QTY WORK  FAIL MH  TASK  OLD EQ SN  TRANS ACT  QTY MH
NO RQD   TO BE RPR CENTER  CD  RMN  ID AND NSN  NEW EQ SN  DATE  COMPL  RPR  EXP
G01  1  REP                1  ELM          0.0                A                1  0.5

                                                EMPLOYEE NO  MH EXPENDED  OVERTIME
                                                G003          0.5          0.0
                                                0.0          0.0
                                                0.0          0.0
                                                0.0          0.0
                                                0.0          0.0
                                                0.0          0.0
                                                0.0          0.0
                                                0.0          0.0

```

Legend for Figure 3-7; completion instructions follow.

**WORK ORDER DATA**

- WON. The 12-position support work order number assigned by the supporting DSU.
- UIC CUST. Customer Unit Identification Number.
- INTNS. In transit Customer. Value is either Y (yes) or N (no).
- REIMB. Applicable to in transit reimbursable customers only. Value is either Y (yes) or N (no).
- SHOP. This unique code identifies the shop in support maintenance.
- SAMS-2 UIC. Self-explanatory.
- UTIL. Utilization Code. See table B-6.
- TYPE MNT. Type Maintenance Request Code. These codes are used to describe the maintenance action requested. See table B-20.
- ID AND NSN. Identification number identifies the type of number in the NSN field; for example, A—National Stock Number (NSN), C—Manufacturers Code Reference Number, D—Management Control Number (MCN), and P—All Others.
- MODEL OR NOUN. Self-explanatory.
- STA DATE TIME. Shows the statuses and the date and times they changed.

**Figure 3-7. Sample SAMS-1 Work Order Detail Report**

ORG WON/DOC. The organizational work order number or document number.

SERIAL NUMBER. Self-explanatory.

ECC. Identifies the equipment category code. See table B-18.

EIC. The end item code assigned to the equipment.

QTY REC. Quantity received.

PD. Priority designator.

MALFUNCTION. Self-explanatory.

FDD. The failure detected during code. A required entry.

EQUIP USAGE. Miles/kilometers/hours/rounds recorded on the item.

PROJ CD. If there is a project code assigned, it is reflected here; otherwise, this is blank.

SNT. The serial number tracking designator. Y (yes) or N (no).

APC. Account processing code. This is a code prescribed locally for costing and budget identification of customers and organizations. May be blank if not required locally.

ORF AUTH. Operational readiness float (ORF) authorized. A Y indicates this is a candidate.

WRNTY. If item is under warranty, a Y is reflected on the report.

BUMPER NO. Self-explanatory.

LVL WORK. Indicates the level of work. A blank indicates a contractor will do the work.

MH (man-hours). Covers three areas:

MH PROJ. The number of man-hours projected in hours and tenths.

MH EXP. The number of man-hours expended in hours and tenths.

MH RMN. The number of man-hours remaining in hours and tenths.

QTY RPR (quantities repaired).

QTY CONDEM (condemned). Are reflected as applicable.

QTY NRTS. Not repairable this station.

EVAC WON. Evacuation work order number, if applicable, is reflected on this report.

ORF TRANS (operational readiness float transfer). An I indicates an ORF item has been issued; R indicates an ORF item has been repaired. Cost data information:

WON. A 12-position support work order number assigned by the supporting DSU. Cost data for direct labor is shown for military and civilian to include the man-hours and the cost, and the total direct labor cost. Also shown is indirect labor cost, when applicable. The repair costs show the total cost for all parts. The last column is the total cost of maintenance.

MIL DIRECT LABOR.

MH. Number of military manhours expended on the work order.

COST. Cost data for military direct labor.

CIV DIRECT LABOR.

MH. Number of civilian manhours expended on the work order.

COST. Cost for civilian direct labor.

TOTAL DIRECT LABOR COST The sum of the MIL Direct labor cost and the CIV direct labor cost.

INDIRECT LABOR. This cost reflects a calculation using direct labor hours and SAMS indirect labor factor and rate.

REPAIR PARTS COST. This is the total of all repair parts cost used to repair the equipment item.

TOTAL COST OF MAINTENANCE. This cost reflects the sum of Total direct labor, total indirect labor and repair parts cost.

TOTALS. Reflects the total cost for each column.

TASK DATA. Shown for planned data completed data.

TASK NO. This code is a unique number assigned at support maintenance.

ACT RQD. Action code. See table B-5.

TASK DESCRIPTION. Self-explanatory.

QTY TO BE RPR. Report reflects the quantity of items to be repaired.

WORK CENTER. A unique code assigned within the support maintenance activity.

FAIL CD. Failure code. See tables B-1 and B-2.

MH RMN. Man-hours remaining or projected to complete the job.

TASK ID AND NSN. For serial number tracking (SNT) only.

OLD/NEW EQ SN. For use with SNT. If a serial numbered item has been replaced, then both numbers are reflected here.

TRANS DATE. For SNT only.

ACT COMPL. The action completed code.

QTY RPR. Quantity repaired.

MH EXP. Man-hours expended.

EMPLOYEE NO. A code used to identify employee.

MH EXPENDED. Man-hours expended.

OVERTIME. Self-explanatory.

**Figure 3-7. Sample SAMS-1 Work Order Detail Report**

---

---

DATE: 20031204

PARTS RECEIVED NOT INSTALLED

AWCMF436

DODAAC: W33VT3

UNIT A CO 3RD BN 7TH INF

DOC NUM	NIIN	QTY DUE	QTY REC	FAULT NUM	DATE COMP	ADMIN#
3325 2213	000103867	00000	00002	0134	20031125	A11
3302 2202	013869109	00000	00003	0003	20031203	A11R1
3295 2213	011024684	00000	00001	0115	20031120	A12
3302 2248	012676154	00000	00001	0119	20031117	A12M
3233 2203	011131100	00000	00001	0086	20031119	A13
3295 2200	014196286	00000	00001	0098	20031027	A13
3295 2204	011073398	00000	00001	0101	20031125	A13
3295 2206	012476628	00000	00001	0102	20031126	A13
3325 2214	013913241	00000	00001	0103	20031124	A13
3325 2217	012452424	00000	00001	0109	20031201	A13
3325 2219	007289957	00000	00001	0109	20031125	A13
3302 2218	013869109	00000	00002	0002	20031203	A13R1
3325 2211	012372953	00000	00001	0122	20031202	A14M
3294 2248	013582537	00000	00001	0370	20031121	A21
3294 2261	007637744	00000	00001	0147	20031027	A21M
3325 2220	012060138	00000	00001	0147	20031125	A21M
3325 2221	012060139	00000	00001	0147	20031125	A21M
3309 2208	014624079	00000	00002	0002	20031203	A21R1
3309 2211	014358079	00000	00002	0006	20031124	A21R1
3309 2214	013869109	00000	00003	0009	20031203	A21R1
3309 2216	014329331	00000	00001	0011	20031202	A21R1
3224 2208	011067829	00000	00001	0287	20031203	A22
3294 2246	012880494	00000	00001	0297	20031202	A22
3294 2247	011131105	00000	00001	0298	20031125	A22
3309 2218	014624079	00000	00001	0002	20031203	A22R1
3309 2219	012474723	00000	00001	0003	20031201	A22R1
3309 2220	014329331	00000	00001	0004	20031202	A22R1
3293 2254	011104215	00000	00001	0364	20031121	A23
3325 2206	012707507	00000	00001	0364	20031202	A23
3325 2207	011267799	00000	00001	0229	20031125	A23M
3325 2208	008298740	00000	00001	0229	20031125	A23M

Legend for Figure 3-8;

completion instructions follow.

This report is printed by DODAAC and Unit name.

DOC NUM. The document number under which the required part(s) was ordered.

NIIN. National Item Identification Number.

QTY DUE. Due-in quantity for the part on order.

QTY REC. The quantity of items received.

FAULT NUM. Shows the fault number for which the part is required.

DATE COMP. The date transaction was completed.

ADMIN #. Self-explanatory.

**Figure 3-8. Sample ULLS-Generated Parts Received Not Installed Report**

---

DATE: 20031204                      SERVICE SCHEDULE                      AWCMF452  
DODAAC: W33VT3                      A CO 3RD BN 7TH INF

-----  
ADMIN NUM: A67                      READING: M 008489  
NSN: 2350012197577                      MODEL: M113A3                      NOUN: CARRIER PERSONNEL  
PUB DATA: TM 9-2350-277-10                      02 07/94 LAST SERVICE: A 20021009  
TM 9-2350-277-10-HR                      02/97

SERVICE DATA							
DATE	TYPE	SERVICE	DUE	INTERVAL	DAYS	READING	DUE
20031009		A		365		M	11398
-----				0		M	0
-----							0
-----							0
-----							0

Legend for Figure 3-9;

completion instructions follow.

DATE: Reflects the date of the printout.

DODAAC. Reflects the DODAAC of the unit followed by unit name.

ADMIN NUM. Self-explanatory.

READING. Reflects the current reading in miles, kilometers or hours as denoted by M, K, or H and the number.

NSN. Reflects the National Stock Number of the equipment.

MODEL. Reflects the model of the equipment.

NOUN. Reflects the Noun of the equipment.

PUB DATA. Reflects the applicable technical manuals and associated date.

LAST SERVICE. Reflects the type and date of the service.

SERVICE DATA.

DATE TYPE SERVICE DUE. Reflects the date and type of the service that is due next.

INTERVAL DAYS. Reflects the number of days until the next service is due.

READING DUE. Reflects the reading type (m - miles, k - kilometers h - hours) and the number when the next service is due.

**Figure 3-9. Sample ULLS-Generated Service Schedule**

Edition of DEC 85 is usable until exhausted.	DA Pams 750-8 and 738-751	1. SUPPORT AGENCY UIC <b>WBIZAA</b>		2. DATE <b>4126</b>		
		3. ORGANIZATION UIC <b>WACCBO</b>		4. <input checked="" type="checkbox"/> WARRANTY <input type="checkbox"/> TMDE <input type="checkbox"/> EIR EXHIBIT <input type="checkbox"/> OTHER		
		5. NSN <b>2815-01-314-7940</b>		6. NOUN NOMENCLATURE <b>ENGINE W/CONTAINER</b>		
		7. PD <b>02</b>		8. PD AUTHENTICATION <i>John W. Carter</i>		
		END ITEM IDENTIFICATION		9. END ITEM NOUN NOMENCLATURE <b>TRUCK 11/4 TON</b>		
				10. MODEL <b>M1037</b>	11. SERIAL NO. <b>437924</b>	
		12. DEFICIENCY OR SYMPTOM <b>ENGINE SEIZED</b>				
		13. DATE ACCEPTED <b>4197</b>		14. SIGNATURE <i>Stephen Smith</i>		15. NMCS <b>YES</b>
		16. WON <b>A803862</b>		17. INITIALS <b>AKD</b>		
		18. DATE REPAIRED <b>4199</b>		19. INITIALS <b>TCL</b>		

COPY 1  
DA FORM 2402, AUG 2004

Legend for Figure 3-10;

completion instructions follow.

1. SUPPORT AGENCY UIC. Enter the UIC of the support activity that receives, holds, or works on the item.
  2. DATE. Enter the Julian date the form was initiated.
  3. ORGANIZATION UIC. Enter the UIC of the owning unit or organization.
  4. WARRANTY/EIR EXHIBIT/TMDE/OTHER. Mark the block to show the use of the form. If form is being used for other, print the use of the form at the bottom of block 2 Date below the Julian date.
  5. NSN. Enter the NSN of the item.
  6. NOUN NOMENCLATURE. Print the noun abbreviation of the item to be repaired.
  7. PD. Enter the priority designator (PD) that applies to the action. The unit or organization listed in block 3 normally assigns the PD. When the form supports a customer maintenance request, use the PD of the maintenance request.
  8. PD AUTHENTICATION. The commander or the commander's designated representative signs when a PD of 01 through 08 is in block 7.
  9. END ITEM NOUN NOMENCLATURE. Enter the noun nomenclature of the end item or end item from which the component came.
  10. MODEL. Enter the model of the end item or end item from which the component came.
  11. SERIAL NO. Enter the serial number of the end item or end item from which the component came.
  12. DEFICIENCY OR SYMPTOM. Enter the deficiency or symptom that caused this maintenance transaction to occur.
- Blocks 13-19. To be filled in by the maintenance support unit.
13. DATE ACCEPTED. Enter the Julian date when the item was accepted.
  14. SIGNATURE. The shop office representative or inspector responsible for repairs signs here.
  15. NMCS. Enter yes or no if this part of the component causes the end item to be not mission capable.
  16. WON. Enter the work order number that was submitted with the item.
  17. INITIALS. The shop foreman enters his/her initials validating that the information on the form is correct and accepting the item.
  18. DATE REPAIRED. Enter the date that the repair is completed or the warranty claim or EIR exhibit are released.
  19. INITIALS. The shop foreman enters his/her initials when the repairs have been completed or the warranty claim or EIR exhibit are released.

Figure 3-10. Sample DA Form 2402



DD Form 314, 1 DEC 53  
PREVIOUS EDITIONS OF THIS FORM MAY BE USED  
PREVENTIVE MAINTENANCE SCHEDULE AND RECORD

	1	2	3	4	5	6	7	8	9	10	11	12	13	14	15	16	17	18	19	20	21	22	23	24	25	26	27	28	29	30	31	
REGISTRATION NUMBER	ADMINISTRATION NO.											NOMENCLATURE											MODEL					ASSIGNED TO				
JAN	A 1 7 0 0																															
FEB																																
MAR																																
APR																																
MAY																																
JUN																																
JUL	S 3 2 0 0																															
AUG																																
SEP																																
OCT																																
NOV																																
DEC																																
REMARKS	NEXT SERVICE ANNUAL 8 JAN 2003 4700 MILES																															
	ANTIFREEZE DATA: -40° ALKALINITY: BLUE 8 JAN 02																															
DATE RECEIVED	RECEIVED FROM											DISPOSITION																				
REGISTRATION NUMBER	ADMINISTRATION NO.											NOMENCLATURE											MODEL					ASSIGNED TO				
NLOCIK	A13											CARR PER SUBSYSTEM (B2) GL C18234											M113A3					A CO, I-61 INF				
02	1	2	3	4	5	6	7	8	9	10	11	12	13	14	15	16	17	18	19	20	21	22	23	24	25	26	27	28	29	30	31	

USAPPC V1.01

Legend for Figure 3-12;

completion instructions follow. Use either the blocks at the top or the bottom of the card. Enter the last two digits of the calendar year in the shaded box at the upper left or lower left of the card.

REGISTRATION NUMBER. The registration number, if the equipment has one assigned, or the serial numbers are entered in it.

ADMINISTRATION NO. The equipments administration number (bumper or locally assigned number). If the equipment does not have an assigned administration number (bumper or locally assigned number), none assigned is penciled in this block.

NOMENCLATURE. Enter the noun abbreviation of the Subsystem in ink in this block.

1. The words Subsystem (B2) or Subsystem (B1) are entered below the noun.

2. For equipment reported under AR 700-138, enter the ECC and LIN under the word, Subsystem (B2) or Subsystem (B1). ECCs are found in table B-18. LINs are in the FED LOG. Use the exact nomenclature format listed in AR 700-138.

MODEL. Enter the model number; for example, M1009. Use the exact model format listed in AR 700-138. Ink Entry.

ASSIGNED TO. Enter the name of the unit organization owning the equipment in pencil.

REMARKS. In pencil, annotate any maintenance information that is needed in the future or on the replacement form for the next year. This information may include service symbols, dates for current and next year, and warranty information. If the equipment is under warranty, print in pencil "Warranted Item" and the length of the warranty in miles, months, hours, or years. The Warranty Control Office or Logistics Assistance Office can assist with warranty data for specific pieces of equipment. Use it when filing out DA Form 2407.

1. Antifreeze entries are made in the Remarks block for equipment under warranty or using commercial or arctic antifreeze. For additional information, see TB 750-651.

2. Cooling systems serviced with antifreeze, Mil-A-46153, require the degree of protection, the condition of the cooling system, and the use of antifreeze extender, Mil-A-53009, recorded in this block. See TB 750-651. PMCS reference, PMCS time, and flight check data are shown for all ATC equipment.

DATE RECEIVED. Leave blank or use as needed locally.

RECEIVED FROM. Leave blank or use as needed locally.

DISPOSITION. Leave blank or use as needed locally.

DATE BLOCKS (front). Indicate services scheduled with pencil entries and services completed with ink pen entries.

DATE BLOCKS (back). Day-by-day breakout of NMC time for system. Mark the days in the date block.

Figure 3-12. Sample DD Form 314, subsystem (B2/B1) (front)





DD Form 314, 1 DEC 53	1	2	3	4	5	6	7	8	9	10	11	12	13	14	15	16	17	18	19	20	21	22	23	24	25	26	27	28	29	30	31		
	REGISTRATION NUMBER				ADMINISTRATION NO.				NOMENCLATURE								MODEL				ASSIGNED TO												
	JAN																																
	FEB																																
	MAR																																
	APR																																
	MAY																																
	JUN																																
	JUL																																
	AUG																																
SEP																																	
OCT																																	
NOV																																	
DEC																																	
REMARKS																																	
PUMP SER# 587979 TANK SER# 487613 HEATER SER# 356-0893																																	
DATE RECEIVED				RECEIVED FROM												DISPOSITION																	
REGISTRATION NUMBER				ADMINISTRATION NO.				NOMENCLATURE								MODEL				ASSIGNED TO													
SEE REMARKS				B120D				DECON APPR SUBSYSTEM (BZ) QM F81880								MIZAI				COB, 142 ECB													
02	1	2	3	4	5	6	7	8	9	10	11	12	13	14	15	16	17	18	19	20	21	22	23	24	25	26	27	28	29	30	31		

USAPPC V1.01

Figure 3-14. Sample DD Form 314 subsystem with components (back)

DD Form 314, 1 DEC 53	1 2 3 4 5 6 7 8 9 10 11 12 13 14 15 16 17 18 19 20 21 22 23 24 25 26 27 28 29 30 31																														
	REGISTRATION NUMBER					ADMINISTRATION NO.					NOMENCLATURE										MODEL					ASSIGNED TO					
	JAN																				O S S S O										
	FEB																														
	MAR					O X X X X X X X																									
	APR																														
	MAY																														
	JUN																														
	JUL																														
	AUG																														
SEP																															
OCT																															
NOV																															
DEC																															
REMARKS																															
DATE RECEIVED								RECEIVED FROM												DISPOSITION											
REGISTRATION NUMBER					ADMINISTRATION NO.					NOMENCLATURE										MODEL					ASSIGNED TO						
NLOBZY					B1204					TRK CGO SYSTEM (B1) HI X40794										M923					CO B, 141 ECB						
02 1 2 3 4 5 6 7 8 9 10 11 12 13 14 15 16 17 18 19 20 21 22 23 24 25 26 27 28 29 30 31																															

USAPPC V1.01

Legend for Figure 3-15;

completion instructions follow. Use either the blocks at the top or the bottom of the card. Enter the last two digits of the calendar year in the shaded box at the upper left or lower left of the card.

REGISTRATION NUMBER. Enter the registration number in ink, if the equipment has one assigned, or the serial number.

ADMINISTRATION NO. Enter the equipment's administration number (bumper or locally assigned number). If the equipment does not have an assigned administration number (bumper or locally assigned number), pencil, none assigned in this block.

NOMENCLATURE. Ink entry.

1. Enter the noun abbreviation of the system.
2. Enter the word system (B1) below the noun.
3. Enter the ECCs and LIN of the system below the word system (B2) or system (B1). ECCs appear in table B18. LINs are in the FED LOG. Use the exact nomenclature format listed in AR 700-138.

MODEL. Enter the model number of the primary item of the system; for example, M1009. Use the exact model format listed in AR 700-138. Ink entry.

ASSIGNED TO. Enter the name of the unit or organization owning the equipment in pencil.

REMARKS. List each Equip End Item in the system, if any. The TM identifies what the Equip End Items are. Enter the serial numbers or other identifying number in pencil beside the Equip End Items.

DATE RECEIVED. Leave blank or use as needed locally.

RECEIVED FROM. Leave blank or use as needed locally.

DISPOSITION. Leave blank or use as needed locally.

DATE BLOCKS. Show day-by-day breakout of NMC time. Mark the days in the date block.

Figure 3-15. Sample DD Form 314 system (B1) (back)



DD Form 314, 1 DEC 53

PREVIOUS EDITIONS OF THIS FORM MAY BE USED

PREVENTIVE MAINTENANCE SCHEDULE AND RECORD

	1	2	3	4	5	6	7	8	9	10	11	12	13	14	15	16	17	18	19	20	21	22	23	24	25	26	27	28	29	30	31								
REGISTRATION NUMBER	ADMINISTRATION NO.											NOMENCLATURE										MODEL					ASSIGNED TO												
JAN												S																											
FEB																																							
MAR																																							
APR																																							
MAY																																							
JUN																																							
JUL												S																											
AUG																																							
SEP																																							
OCT																																							
NOV																																							
DEC																																							
REMARKS																																							
DATE RECEIVED								RECEIVED FROM														DISPOSITION																	
REGISTRATION NUMBER								ADMINISTRATION NO.								NOMENCLATURE										MODEL					ASSIGNED TO								
NL01CA								C102								TRAILER CARGO HEAVY EQUIP END ITEM HT T95992										M1102					C CO, I-21 INF								
	1	2	3	4	5	6	7	8	9	10	11	12	13	14	15	16	17	18	19	20	21	22	23	24	25	26	27	28	29	30	31								

USAPPC V1.01

Legend for Figure 3-17;

completion instructions follow. Use either the blocks at the top or the bottom of the card. Enter the last two digits of the calendar year in the shaded box at the upper left or lower left of the card.

REGISTRATION NUMBER. Enter the registration number, if the equipment has one assigned, or the serial number. Ink entry.

ADMINISTRATION NO. Enter the equipment's administration number (bumper or locally assigned number). If the equipment does not have an assigned administration number (bumper or locally assigned number), pencil, none assigned in this block.

NOMENCLATURE. Ink entry.

1. Enter the noun abbreviation in this block.

2. Enter the word, Equip End Item below the noun.

3. Place the ECC and LIN under the words, Equip End Item. ECCs are available in table B-18. LINs are in the FED LOG. Use the exact nomenclature format listed in the FED LOG.

MODEL. Enter the model number; for example, M1009. Use the exact model format listed in AR 700-138. Ink Entry.

ASSIGNED TO. Enter the name of the unit or organization owning the equipment in pencil.

REMARKS. In pencil, annotate any maintenance information that is needed in the future or on the replacement form for the next year. This information may include service symbols, dates for current and next year, and warranty information. If the equipment is under warranty, print in pencil "Warranted Item" and the length of the warranty in miles, months, hours, or years. The Warranty Control Office or Logistics Assistance Office can assist with warranty data for specific pieces of equipment. Use it when filling out DA Form 2407.

1. Antifreeze entries are made in the Remarks block for equipment under warranty or using commercial or arctic antifreeze. For additional information, see TB 750-651.

2. Cooling systems serviced with antifreeze, Mil-A-46153, require the degree of protection, the condition of the cooling system, and the use of antifreeze extender, Mil-A-53009, recorded in this block. See TB 750-651. PMCS reference, PMCS time, and flight check data are shown for all ATC equipment.

DATE RECEIVED. Leave blank or use as needed locally.

RECEIVED FROM. Leave blank or use as needed locally.

DISPOSITION. Leave blank or use as needed locally.

DATE BLOCKS. Indicate services scheduled with pencil entries and services completed with ink pen entries.

Figure 3-17. Sample DD Form 314 used for equipment end item



DD Form 314, 1 DEC 53

PREVIOUS EDITIONS OF THIS FORM MAY BE USED

PREVENTIVE MAINTENANCE SCHEDULE AND RECORD

	1	2	3	4	5	6	7	8	9	10	11	12	13	14	15	16	17	18	19	20	21	22	23	24	25	26	27	28	29	30	31		
REGISTRATION NUMBER	ADMINISTRATION NO.											NOMENCLATURE										MODEL					ASSIGNED TO						
JAN						M	1	0	0	(	H)																						
FEB																																	
MAR						M	1	0	0	(	H)																						
APR						M	1	0	0	(	H)																						
MAY						M	1	0	0	(	H)																						
JUN						M	1	0	0	(	H)																						
JUL						M	1	0	0	(	H)																						
AUG																																	
SEP						M	1	0	0	(	H)																						
OCT						M	1	0	0	(	H)																						
NOV						M	1	0	0	(	H)																						
DEC						M	1	0	0	(	H)																						
REMARKS	NEXT ANNUAL SERVICE 1000 15 FEB 02																																
(H) = HOURS																																	
DATE RECEIVED	RECEIVED FROM											DISPOSITION																					
REGISTRATION NUMBER	ADMINISTRATION NO.											NOMENCLATURE										MODEL					ASSIGNED TO						
	A101E											GEN ST, 10KW 60HZ COMPONENT										MEP-003A					A CO, F71 INF						
02	1	2	3	4	5	6	7	8	9	10	11	12	13	14	15	16	17	18	19	20	21	22	23	24	25	26	27	28	29	30	31		

USAPPC V1.01

Figure 3-19. Sample DD Form 314 component card

SYSTEM (B2)

- NMC DATA ONLY
- COMBINES SUBSYSTEM DOWNTIME FOR REPORTING PURPOSES

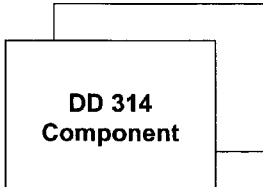
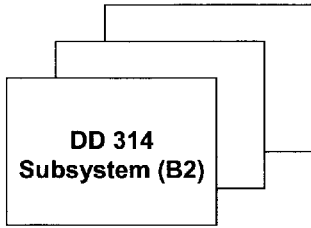
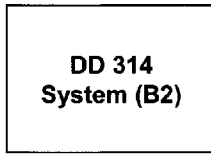

SUBSYSTEM (B2/B1)

- FRONT SIDE REFLECTS SERVICE DATA
- REVERSE SIDE REFLECTS NMC TIME
- MAY HAVE COMPONENTS

COMPONENT

- REFLECTS SERVICE DATA ONLY

SYSTEM (B1)

- FRONT SIDE REFLECTS SERVICE DATA
- REVERSE SIDE REFLECTS NMC TIME
- MAY BE SEPARATE ITEM OR HAVE SUPPORT ITEMS OR COMPONENTS

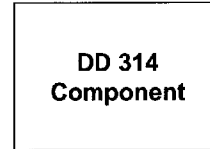
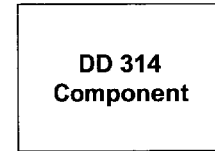
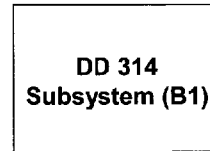
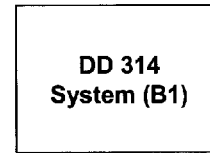

Figure 3-20. DD Form 314 flow chart



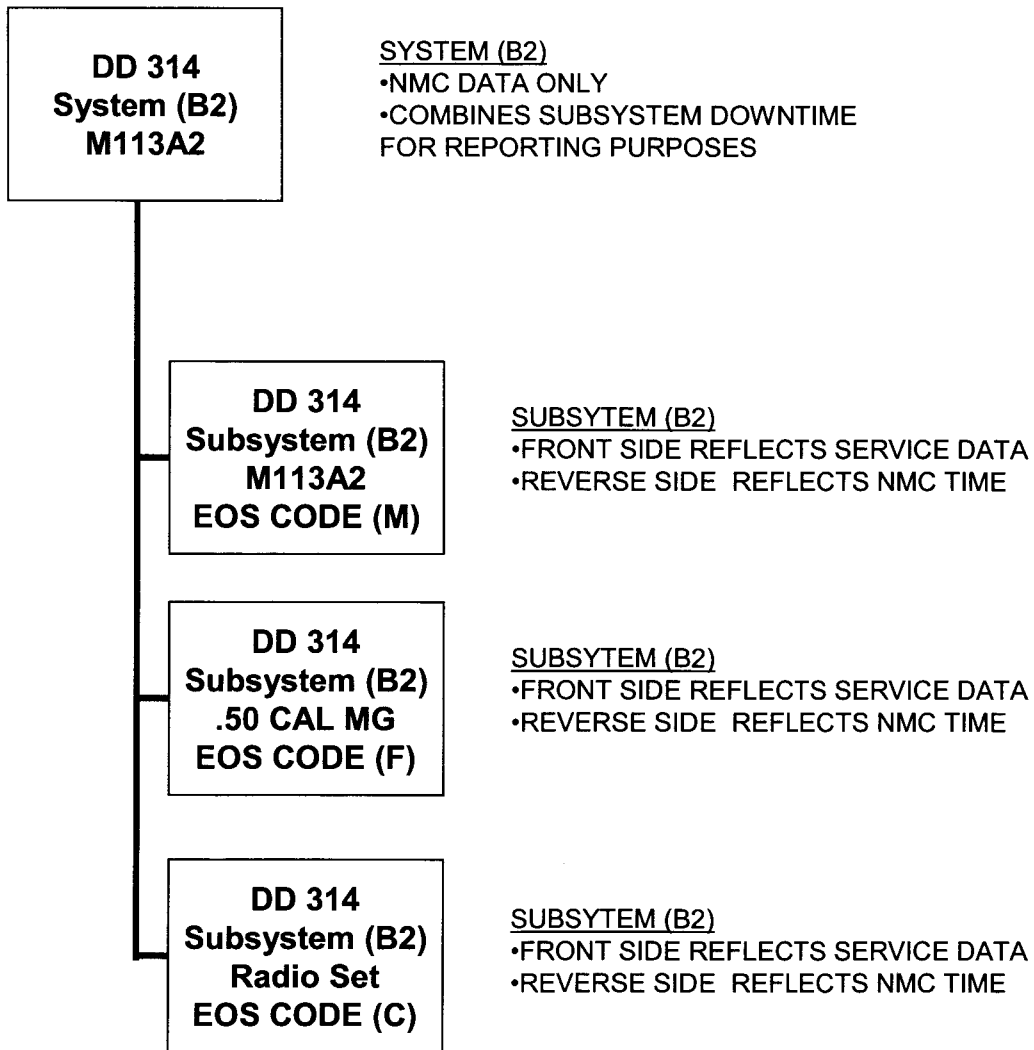
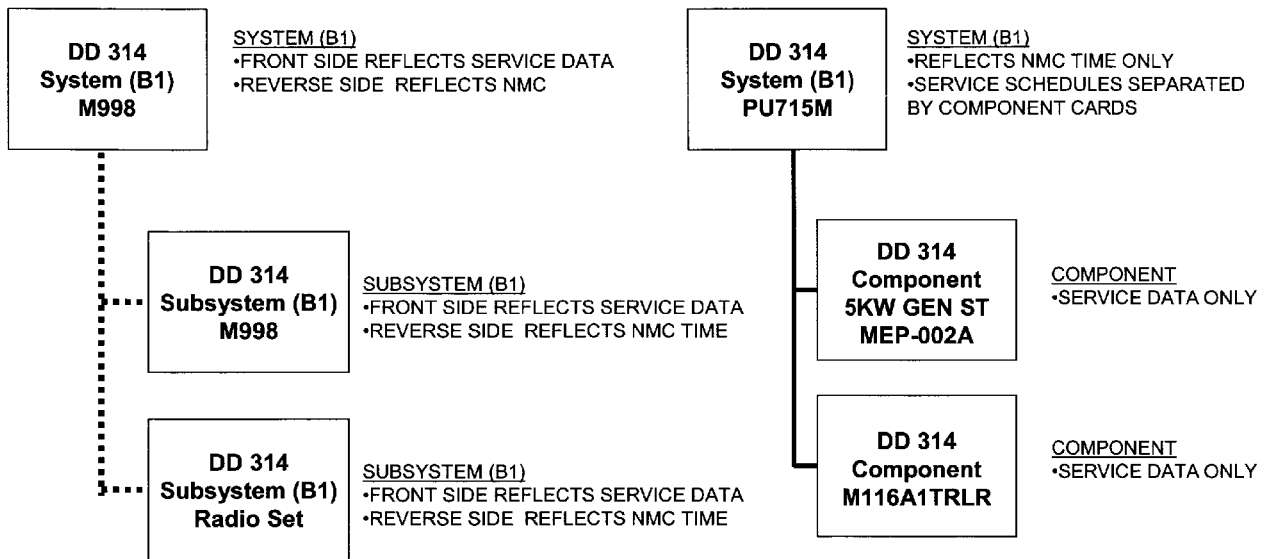

Figure 3-21. Sample DD Form 314 used for system B2 requirements



TECHNICAL MANUAL WILL DETERMINE WHETHER TO BREAK OUT SERVICE SCHEDULES ON SEPARATE COMPONENT CARDS

Figure 3–22. Sample DD Form 314 used for system B1 requirements

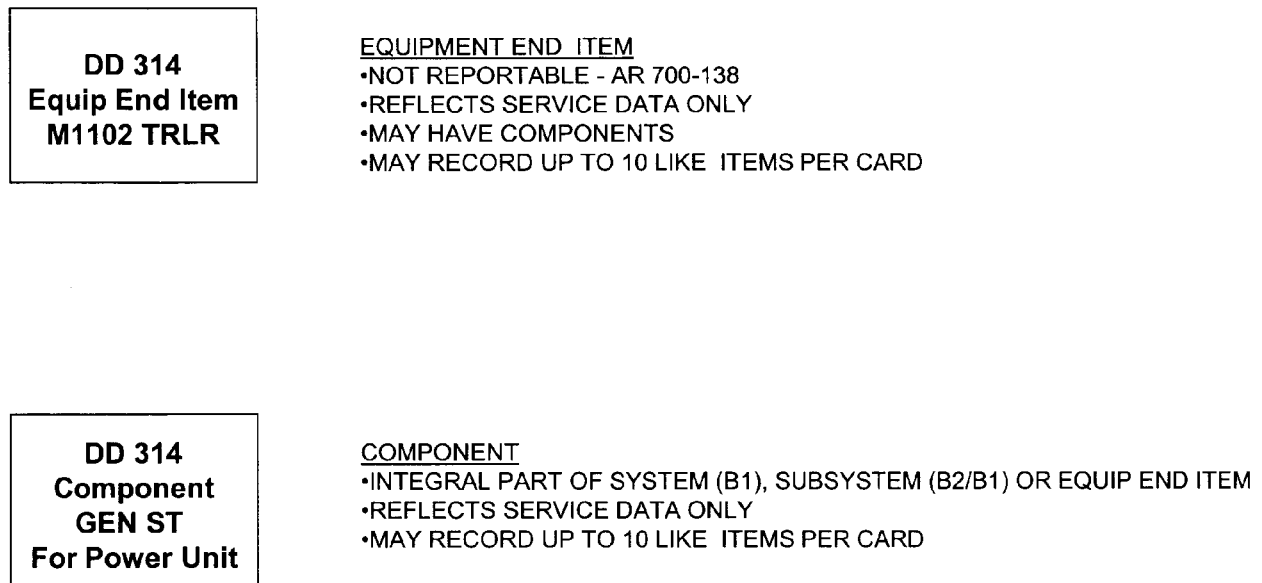

Figure 3–23. Sample DD Form 314 used for equipment end items and component requirements

DATE: 20031205

EQUIPMENT MAINTENANCE AND INSPECTION WORKSHEET

DA FORM 5988-E

W33VT7

HQ 3D BN 7TH IN

EQUIPMENT DATA

ADMIN NUM: HQ903 EQUIP SERIAL NUM: 038537
EQUIP MODEL: M998 REGISTRATION NUM: NG2PZX
EQUIP NOUN: TRK UTL CGO 1.25T 4X4 TYPE INSPECTION: W
EQUIP NSN: 2320011077155 CURRENT READING: M 002238

PUBLICATION: TM 9-2320-280 10 DATE 01/96 CHANGE NUMBER 03
PUBLICATION: TM 9-2320-280-10-HR DATE 05/99 CHANGE NUMBER 00

INSPECTORS LIC #: F3727 TIME: 0900 SIGNATURE [Signature] 567 TIME: 1115

PARTS REQUESTED

Table with columns: FAULT DOC NUM, NIIN, NOUN, QTY DUE/REC, STATUS DATE, DATE COMP, P D R L I C. Rows include GASKET, SEAL PLAIN, PACKING, PR, FILTER ELE, GASKET.

MAINTENANCE FAULTS

Table with columns: ITEM NUM, FAULT DATE, FAULT STATUS, FAULT DESCRIPTION, CORRECTIVE ACTION, OPER HRS LIC #. Includes handwritten entry: Canvas not mounted correctly, Remounted.

Legend for Figure 3-24; completion instructions follow.

EQUIPMENT DATA.

ADMIN NUM, EQUIP MODEL, EQUIP NOUN, EQUIP NSN, EQUIP SERIAL NUM, and REGISTRATION NUM is retrieved from the equipment data file. No entries from the operator/crew chief are needed in these areas. The operator/crew chief must ensure that data contained in these areas are correct prior to pulling PMCS. If any fields are not current, notify the ULLS operator so he/she can update the data fields through the ULLS Menu process. For more information about these data fields, refer to the ULLS End User Manual. TYPE INSPECTION. Operator/crew chief requests the ULLS operator to print an Equipment Maintenance and Inspection Worksheet with the type inspection to be performed. See ULLS End User Manual or chapter 3 of this pamphlet for an explanation of these symbols.

Figure 3-24. Sample DA Form 5988-E used for operator/crew PMCS

1. Use the same worksheet for more than 1 day. If no faults are found during the BEFORE OPERATION checks in the PMCS, write the calendar date under the fault description column.

2. When no faults are found, this worksheet can be used for more than 1 day even if the worksheet was used for concurrent PMCSs; that is, W/M. Just place the first letter of the type of PMCS performed (W/M) under the corrective action column by that day's date in the fault description column.

CURRENT READING and PUBLICATION (with changes). These are retrieved from the equipment data file. No entries from the operator/crew chief are needed in these areas.

INSPECTOR'S LIC #. A space for the inspector to enter their license number (first letter of last name and last four of SSN) and the time of inspection completion.

SIGNATURE and TIME. When a deficiency or shortcoming is found, the signature and time of operator or supervisor are required. This signature keeps the form from being used past current dispatch. The commander or the commander's designated representative signs name and enters rank when making a status symbol change, or when changing from an X to a CIRCLED X (E) status symbol for a one-time operation.

TIME. Leave blank or use as needed locally. For missile systems/subsystems reported under AR 700-138, enter the time when a deficiency was found.

PARTS REQUESTED. The system checks the Document Control Register and prints any parts that have been ordered against the admin number on the worksheet. Operator/crew chiefs and supervisors review this section and take appropriate action as required. For more information about this section, see the AISM 25-L3Q-AWC-ZZZ-EM.

FAULT. The fault number for which the part is requested.

DOC NUMBER. The document number under which the required part has been ordered.

NIIN. National Item Identification Number.

NOUN. Part nomenclature.

QTY DUE/REC. Due-in quantity for the part on order or the quantity received.

STATUS DATE. The date of status code.

DATE COMP. The date that all parts were received for document number listed or transaction closed.

PRI. The priority for item ordered.

DLC. Deadline code. D if deadlined; N if not deadlined.

MAINTENANCE FAULTS.

1. ITEM NUM. Write the PMCS item number that applies to the fault listed in this column. If the PMCS has no item numbers, list the page, paragraph, or sequence number. Circle the number if fault is listed in the "Equipment is not ready/available if" column or "Not Mission Capable if" column of the PMCS. If the PMCS has no ready/available or NMC column, circle the TM item number, page, or paragraph number of any fault that makes equipment NMC. Pubs or TM sections other than PMCS may be required for safety faults or local dispatching. For example, AR 385-55 lists safety checks that may not be in the PMCS. Those faults are not counted as NMC for Materiel Condition Status Report reporting unless they are in the PMCS not ready column or the NMC column. But, list them if a problem is found with one of them. For those faults not covered by the PMCS, leave this column blank.

FAULT DATE. Enter the calendar date the deficiency or shortcoming was found.

FAULT STATUS. Enter the status symbol that applies to the fault or deficiency.

FAULT DESCRIPTION. Repair of status symbol X faults cannot be postponed or delayed, but they may be changed to CIRCLED X status symbol for limited operation. The commander or the commander's designated representative may change an X status symbol fault to a CIRCLED X status symbol. Changing of status symbols should only be done when the equipment is crucial to the mission. No X status symbol faults are changed to a CIRCLED X if it endangers the operator/crew or may cause further damage to the equipment. CIRCLED X conditions are for one-time operation or mission (common sense must be used).

1. If a fault can be repaired, stop the PMCS and correct the fault. Do not enter faults that have been repaired or already listed on the worksheet. Continue the PMCS to make sure no other faults exist.

2. Briefly describe fault. Skip one or two lines between faults. This gives maintenance room to note actions they take.

3. When more than one TM covers the equipment, draw a line under the last entry for one TM. Under the line, write the TM number of the manual to be used next. After the PMCS is finished and all faults that could not be fixed are listed, give the form to the maintenance supervisor.

CORRECTIVE ACTION. Explain corrective actions taken.

1. Print Cleared for Limited Operations. Provide the specific limits under which equipment can be operated. For example, limits may involve speed, type of mission, distance, weather, or time. The change may affect a subsystem of a system listed in AR 700-138. If so, make sure limits include that part of the mission the system can no longer do.

2. Deficiencies changed to a CIRCLED X return to an X status symbol at the end of the day or mission.

3. Equipment cleared for limited operations is still carried as NMC for the Materiel Condition Status Reporting.

4. When a deficiency is corrected or changed to a CIRCLED X, enter the miles and calendar date in the corrective action column at the end of the dispatch or operation.

5. OPER HRS LIC #. The hours are posted in tenths and are only used when faults are corrected. The license number identifies the individual that corrected a fault or identified a fault.

**Figure 3-24. Sample DA Form 5988-E used for operator/crew PMCS**

EQUIPMENT INSPECTION AND MAINTENANCE WORKSHEET										
For use of this form, see DA PAM 750-8 and 738-751, the proponent agency is DCS, G4										
1. ORGANIZATION Co B 142 ECB (HV)					2. NOMENCLATURE AND MODEL Trk CGO M923					B401
3. REGISTRATION/SERIAL/NSN NL0DUU			4a. MILES 13603	b. HOURS 118	c. ROUNDS FIRED	d. HOT STARTS	5. DATE 20 JAN 97		6. TYPE INSPECTION PMCS	
7. APPLICABLE REFERENCE										
TM NUMBER 9-2320-272-10			TM DATE Aug 96		TM NUMBER			TM DATE		
COLUMN a - Enter TM item number.					COLUMN d - Show corrective action for deficiency or shortcoming listed in Column c.					
COLUMN b - Enter the applicable condition status symbol.					COLUMN e - Individual ascertaining completed corrective action initial in this column.					
COLUMN c - Enter deficiencies and shortcomings.										
STATUS SYMBOLS										
"X"-Indicates a deficiency in the equipment that places it in an inoperable status.					DIAGONAL "/"-Indicates a materiel defect other than a deficiency which must be corrected to increase efficiency or to make the item completely serviceable.					
CIRCLED "X"-Indicates a deficiency, however, the equipment may be operated under specific limitations as directed by higher authority or as prescribed locally, until corrective action can be accomplished.					LAST NAME INITIAL IN BLACK, BLUE-BLACK INK, OR PENCIL Indicates that a completely satisfactory condition exists.					
HORIZONTAL DASH "-"-Indicates that a required inspection, component replacement, maintenance operation check, or test flight is due but has not been accomplished, or an overdue MWO has not been accomplished.					FOR AIRCRAFT-Status symbols will be recorded in red.					
ALL INSPECTIONS AND EQUIPMENT CONDITIONS RECORDED ON THIS FORM HAVE BEEN DETERMINED IN ACCORDANCE WITH DIAGNOSTIC PROCEDURES AND STANDARDS IN THE TM CITED HEREON.										
8a. SIGNATURE (Person(s) performing inspection)			8b. TIME		9a. SIGNATURE (Maintenance Supervisor)			9b. TIME		10. MANHOURS REQUIRED
Eric A. Olerud SFC.										
TM ITEM NO. a	STATUS b	DEFICIENCIES AND SHORTCOMINGS c			CORRECTIVE ACTION d			INITIAL WHEN CORRECTED e		
		14 JAN 97						RM		
		15 JAN 97			W			MP		
		16 JAN 97						DM		
		17 JAN 97						JA		
		18 JAN 97						JA		
		19 JAN 97						EB		
		20 JAN 97								
(35)	X	Right Front Wheel Stud Broken								

DA FORM 2404  
1 APR 79

Replaces edition of 1 Jan 64, which will be used

- Notes:
- <sup>1</sup> Administrative/bumper number is placed in upper right hand corner or as prescribed by local SOP.
- Legend for Figure 3-25; completion instructions follow.
1. ORGANIZATION. Enter the name of the unit to which the equipment belongs.
  2. NOMENCLATURE AND MODEL.

Figure 3-25. Sample DA Form 2404 used for operator/crew PMCS (fault noted)

- a. Enter the noun abbreviation and the model of the equipment.
- b. For watercraft, use the noun abbreviation and Hull Design Number.
- 3. REGISTRATION/SERIAL/NSN.
  - a. Enter the serial or registration number. Enter the NSN when no serial or registration number is available.
  - b. For watercraft, enter the DA Hull Number.
- 4a. MILES. When a deficiency or a shortcoming is found, enter the miles or kilometers on the equipment's odometer at the end of operation. Round to the nearest mile or kilometer. Enter the letter K before the number if the reading is kilometers. Leave blank if the item does not have an odometer or if no faults are found.
- b. HOURS. When a deficiency or a shortcoming is found, enter the hour meter reading at the end of operation. Leave blank if hours do not apply to the equipment or if no faults are found.
- c. ROUNDS FIRED. Leave blank.
- d. HOT STARTS. Leave blank.
- 5. DATE. Enter the calendar date the deficiency or shortcoming was found.
- 6. TYPE INSPECTION. Enter PMCS.
  - a. Use the same DA Form 2404 for more than 1 day. If no faults are found during the BEFORE OPERATION checks in the PMCS, enter the date in column c. If no faults are found DURING or AFTER OPERATION, initial in column e.
  - b. When no faults are found, this form can be used for more than 1 day even if form was used for concurrent PMCSs, for example, W/M. Just place the first letter of the type of PMCS performed (W/M) in column d, by the days date in column c after the PMCS was performed.
- 7. APPLICABLE REFERENCE.
  - TM NUMBER, TM DATE.
    - a. Enter the number and date of the PMCS TM. When two TMs cover an item, enter the second TM number and date in the second number and date block.
    - b. When the manual has changes, print W/C and the latest change number after the TM number. Then, enter the latest change date in the TM date block.
  - 8a. SIGNATURE (*Person(s) performing inspection*). When a deficiency or shortcoming is found, the operator or supervisor signs and enters rank. A signature in this block keeps the form from being used past current dispatch.
  - 8b. TIME. Leave blank or use as needed locally.
  - 9a. SIGNATURE (*Maintenance Supervisor*). Maintenance supervisor or the commander's designated representative signs when corrective action is taken.
  - 9b. TIME. Leave blank or use as needed locally. For a missile system and missile subsystems reported under AR 700-138, chapter 4, enter the time when item was found to be NMC.
- 10. MANHOURS REQUIRED. Leave blank or use as needed locally.
  - TM ITEM NO. a.
    - a. Enter the PMCS item number that applies to the fault listed in column c. If the PMCS has no item numbers, list the page, paragraph, or sequence number. Circle the number if the fault is listed in the Equipment is not ready/available if column or Not Mission Capable if column of the PMCS. If the PMCS has no ready/available or NMC column, circle the TM item number, page, paragraph number of any fault that makes the equipment NMC.
    - b. Pubs or TM section other than PMCS may be required for safety faults or local dispatching. For example, AR 385-55 lists safety checks that may not be in the PMCS. Those faults are not counted as NMC for DA Form 2406 (Materiel Condition Status Report) unless they are in the PMCS not ready column or the NMC column. But, list them if a problem is found with one of them.
    - c. For those faults not covered by the PMCS, leave this column blank.
  - STATUS b. Enter the status symbol that applies to the fault or deficiency.
  - DEFICIENCIES AND SHORTCOMINGS c.
    - a. If a fault that can be repaired is found, stop the PMCS and correct the fault. Do not enter faults that have been repaired on DA Form 2404. Continue the PMCS to make sure no other faults exist.
    - b. Briefly describe the fault. Skip one or two lines between faults. This gives maintenance room to note actions they take.
    - c. When more than one TM covers the equipment, draw a line under the last entry for one TM. Under the line, write the TM number of the manual to be used next. After the PMCS is finished and all faults that could not be fixed are listed, give the form to the maintenance supervisor.
    - d. When using one DA Form 2404 for more than one item of equipment, enter the serial number or administration number for the item with the fault. Write the fault on the line below the serial number. When faults not covered by the PMCS are listed, add the pub that covers them; for example, SOP or AR 385-55.
  - CORRECTIVE ACTION d. Explain corrective actions taken.
  - INITIAL WHEN CORRECTED e. The mechanic initials any faults that have been fixed. The initials go on the last line for the entry in column d. The maintenance supervisor reviews the faults corrected and those still not fixed to decide what other action is needed. For quality control, the inspector or a designated representative checks all corrected status symbol X faults. The inspector then initials the status symbol.

**Figure 3-25. Sample DA Form 2404 used for operator/crew PMCS (fault noted)**

EQUIPMENT INSPECTION AND MAINTENANCE WORKSHEET											
For use of this form, see DA PAM 750-8 and 738-761; the proponent agency is DCS, G4											
1. ORGANIZATION B Co 2/33d Armor					2. NOMENCLATURE AND MODEL Rifle, 5.56mm M16A2						
3. REGISTRATION/SERIAL/NSN		4a. MILES		b. HOURS		c. ROUNDS FIRED		d. HOT STARTS		5. DATE	6. TYPE INSPECTION
										10 Feb 97	Quarterly
7. APPLICABLE REFERENCE											
TM NUMBER 9-1005-319-23 P W/C				TM DATE Aug 87		TM NUMBER		TM DATE			
COLUMN a - Enter TM item number.				COLUMN b - Enter the applicable condition status symbol.		COLUMN c - Enter deficiencies and shortcomings.		COLUMN d - Show corrective action for deficiency or shortcoming listed in Column c.			COLUMN e - Individual ascertaining completed corrective action initial in this column.
STATUS SYMBOLS											
"X"-Indicates a deficiency in the equipment that places it in an inoperable status.					DIAGONAL "/"-Indicates a materiel defect other than a deficiency which must be corrected to increase efficiency or to make the item completely serviceable.						
CIRCLED "X"-Indicates a deficiency, however, the equipment may be operated under specific limitations as directed by higher authority or as prescribed locally, until corrective action can be accomplished.					LAST NAME INITIAL IN BLACK, BLUE-BLACK INK, OR PENCIL-Indicates that a completely satisfactory condition exists.						
HORIZONTAL DASH "-"-Indicates that a required inspection, component replacement, maintenance operation check, or test flight is due but has not been accomplished, or an overdue MWO has not been accomplished.					FOR AIRCRAFT-Status symbols will be recorded in red.						
ALL INSPECTIONS AND EQUIPMENT CONDITIONS RECORDED ON THIS FORM HAVE BEEN DETERMINED IN ACCORDANCE WITH DIAGNOSTIC PROCEDURES AND STANDARDS IN THE TM CITED HEREON.											
8a. SIGNATURE (Person(s) performing inspection)				8b. TIME		8c. SIGNATURE (Maintenance Supervisor)		8d. TIME		10. MANHOURS REQUIRED	
Barry McBurnett SPC						CPT Connie Carlson					
TM ITEM NO.	STATUS	DEFICIENCIES AND SHORTCOMINGS				CORRECTIVE ACTION			INITIAL WHEN CORRECTED		
a	b	c				d			e		
(4)	X	SN: 7151766 Barrel assy loose				DA Form 2407 (Spt)			BM		
(2)	X	SN: 7155093 Weapon will fire in safe position				DA Form 2407 (Spt)			BM		
4	/	SN: 7155511 Ejection part cover spring broken				5360-00-978-1025 Doc #7057-0007			BM		

DA FORM 2404  
1 APR 79

Replaces edition of 1 Jan 84, which will be used

Notes:

<sup>1</sup> Administrative number/bumper number is entered in the upper right-hand corner or as prescribed by local SOP.

Legend for Figure 3-26;

completion instructions follow for services on more than one like item.

1. ORGANIZATION. Enter the name of the unit to which the equipment belongs.

2. NOMENCLATURE AND MODEL.

Figure 3-26. Sample DA Form 2404 used for services on more than one like item

- a. Enter the noun abbreviation and the model of the equipment.
- b. For watercraft, use the noun abbreviation and Hull Design Number.
- 3. REGISTRATION/SERIAL/NSN.
  - a. Enter the serial or registration number. Enter the NSN when no serial number or registration number is available.
  - b. For watercraft, enter the DA Hull Number.
  - c. For more than one item, leave blank.
- 4a. MILES. When a deficiency or a shortcoming is found or a service is performed, enter the miles or kilometers on the equipment's odometer. Round to the nearest mile or kilometer. Enter the letter K before the number if the reading is in kilometers. Leave blank if the item does not have an odometer or if no faults are found.
- b. HOURS.
  - a. When a deficiency or a shortcoming is found or a service is performed, enter the hour meter reading.
  - b. Leave blank if hours do not apply to the equipment or if no faults are found.
- c. ROUNDS FIRED. Leave blank.
- d. HOT STARTS. Leave blank.
- 5. DATE. Enter the calendar date the service is performed or the shortcoming was found.
- 6. TYPE INSPECTION.
  - a. Enter the type of inspection or service to be done (lubrication, monthly, quarterly, semiannual, and so on).
  - b. When doing more than one inspection or service at the same time, enter the service symbols in block 6 (for example, L/S).
- 7. APPLICABLE REFERENCE.
  - TM NUMBER, TM DATE.
    - a. Enter the number and date of the PMCS TM. When two TMs cover an item, enter the second TM number and date in the second TM number and date block.
    - b. When the manual has changes, print W/C and the latest change number after the TM number. Then, enter the latest change date in TM date block.
  - 8a. SIGNATURE (*Person(s) performing inspection*). Personnel performing service/inspection signs and enters rank after inspection is completed.
  - 8b. TIME. Leave blank or use as needed locally.
  - 9a. SIGNATURE (*Maintenance Supervisor*). The maintenance supervisor or the commander's designated representative signs name and enters rank after service/inspection is completed.
  - 9b. TIME. Leave blank or use as needed locally. For missile systems or missile subsystem items reported under AR 700–138, chapter 4, enter the time when item was found to be NMC.
- 10. MANHOURS REQUIRED. Leave blank or use as needed locally.
- TM ITEM NO. a.
  - a. Enter the PMCS item number that applies to the fault listed in column c. If the PMCS has no item numbers, list the page, paragraph, or sequence number. Circle the number if the fault is listed in the Equipment not ready/available column or Not Mission Capable column of the PMCS. If the PMCS has no ready/available or NMC column, circle the TM item number, page, or paragraph number of any fault that makes the equipment NMC.
  - b. Pubs or TM sections other than PMCS may be required for safety faults or local dispatching. For example, AR 385–55 lists safety checks that may not be in the PMCS. Those faults are not counted as NMC for DA Form 2406 unless they are listed in the PMCS not ready column or the NMC column. But, list them if a problem with one of them is found.
  - c. For those faults not covered by the PMCS, leave this column blank.
- STATUS b. Enter the status symbol that applies to the fault or deficiency.
- DEFICIENCIES AND SHORTCOMINGS c.
  - a. When using one DA Form 2404 for more than one item of equipment, enter the serial or administration number for the item with the fault. Write the fault on the line below the serial or administration number.
  - b. If a fault that can be repaired is found, stop the PMCS and correct the fault. Do not enter faults on DA Form 2404 that have been repaired. Continue the PMCS to ensure that no other faults exist.
  - c. Briefly describe uncorrected faults.
  - d. If any items require support maintenance, a separate DA Form 2404 is completed and attached to a DA Form 2407.
- CORRECTIVE ACTION d.
  - a. Explain corrective action taken.
  - b. If parts are needed, the PLL clerk orders them and enters the document number.
  - c. Faults that need support maintenance go on a DA Form 2407. Print DA Form 2407 (SPT) in column d.
  - d. The commander's designated representative decides what maintenance can be delayed. Faults that do not affect the operation of the equipment and the operators safety can be deferred because:
    - (1) Support is backed up and cannot get to the equipment right away.
    - (2) The needed repair part is not on hand.
    - (3) Other reasons at the commanders discretion. Faults that the commander's designated representative decides to defer go on DA form 2408–14. Print DA Form 2408–14 in column d for those items.

**Figure 3–26. Sample DA Form 2404 used for services on more than one like item**



INITIAL WHEN CORRECTED. The person making the corrective action or transferring the information initials other entries. The initials go on the last line of the entry. For quality control, the inspector or commander's designated representative checks all corrected status symbol X faults to ensure proper repairs have been completed. If properly repaired, the inspector or the commander's designated representative initials the status symbol.

Figure 3-26. Sample DA Form 2404 used for services on more than one like item

DATE: 20020910		EQUIPMENT MAINTENANCE AND INSPECTION WORKSHEET		DA FORM 5988-E		
W45U7D		D TROOP, 6TH CBAC				
----- EQUIPMENT DATA -----						
ADMIN NUM:	D3	EQUIP SERIAL NUM:	012534198			
EQUIP MODEL:	M35A2WW	REGISTRATION NUM:	4K8868			
EQUIP NOUN:	TRK CGO 2.5T 6X6 WW	TYPE INSPECTION:	A			
EQUIP NSN:	2320000771617	CURRENT READING:	M 013335			
	NUMBER	DATE	CHANGE NUMBER			
PUBLICATION:	TM 9-2320-361-10	12/88	04			
PUBLICATION:	TM 9-2320-209-10-1-HR	01/82				
INSPECTORS LIC #:	MZ142	TIME:		SIGNATURE:	<i>Julio Valera</i>	
----- PARTS REQUESTED -----						
FAULT DOC NUM	NIN	NOUN	QTY DUE/REC	STATUS DATE	DATE COMP	P D R L I C
0016	1200 0025 009034790	WIRE ROPE, 00001	----	-----	-----	12N
0018	1200 0027 002977106	PACKINGXPR 00001	----	-----	-----	12N
0019	1200 0028 003584636	ELEMENT 00001	----	-----	-----	12N
0020	1200 0029 002882692	CHOCK,WH 00001	----	-----	-----	12N
0021	1200 0030 003017756	SIDE RACK, 00001	----	-----	-----	12N
----- MAINTENANCE FAULTS -----						
ITEM NUM	FAULT DATE	FAULT STATUS	FAULT DESCRIPTION	CORRECTIVE ACTION	OPER HRS LIC #	
0016	20010719	/	WIRE ROPE CUT		---	
0018	20010719	/	PACKING TORN		---	
0019	20010719	/	ELEMENT BURNT OUT		---	
0020	20010719	/	WHEEL CHOCK MISSING		---	
0021	20010719	/	RACK ASSEMBLY BENT		---	
0022	20020817	/	HYDRAULIC HOSE LEAKING		---	
0023	20020814	/	BLACKOUT LITE INOP		---	
0023		/	<i>repaired wire</i>		<i>.5 K1345</i>	

Figure 3-27. Sample ULLS-generated DA Form 5988-E used for maintenance services and inspections

EQUIPMENT INSPECTION AND MAINTENANCE WORKSHEET										
For use of this form, see DA PAM 750-8 and 738-751; the proponent agency is DCS, G4										
1. ORGANIZATION 715 <sup>th</sup> Maint Co					2. NOMENCLATURE AND MODEL Trk Util M998					W23
3. REGISTRATION/SERIAL/NSN NG3GFN		4a. MILES 13759	b. HOURS	c. ROUNDS FIRED	d. HOT STARTS	5. DATE 17 Jan 97		6. TYPE INSPECTION Annual		
7. APPLICABLE REFERENCE										
TM NUMBER 9-232φ-28φ-2φ-1/-2/3			TM DATE Jan 96		TM NUMBER 9-232φ-28φ-24P-1/-2			TM DATE Jan 96		
COLUMN a - Enter TM item number.					COLUMN d - Show corrective action for deficiency or shortcoming listed in Column c.					
COLUMN b - Enter the applicable condition status symbol.					COLUMN e - Individual ascertaining completed corrective action initial in this column.					
COLUMN c - Enter deficiencies and shortcomings.										
STATUS SYMBOLS										
"X"-Indicates a deficiency in the equipment that places it in an inoperable status.					DIAGONAL "(/)"-Indicates a materiel defect other than a deficiency which must be corrected to increase efficiency or to make the item completely serviceable.					
CIRCLED "X"-Indicates a deficiency, however, the equipment may be operated under specific limitations as directed by higher authority or as prescribed locally, until corrective action can be accomplished.					LAST NAME INITIAL IN BLACK, BLUE-BLACK INK, OR PENCIL-Indicates that a completely satisfactory condition exists.					
HORIZONTAL DASH "(-)"-Indicates that a required inspection, component replacement, maintenance operation check, or test flight is due but has not been accomplished, or an overdue MWO has not been accomplished.					FOR AIRCRAFT-Status symbols will be recorded in red.					
ALL INSPECTIONS AND EQUIPMENT CONDITIONS RECORDED ON THIS FORM HAVE BEEN DETERMINED IN ACCORDANCE WITH DIAGNOSTIC PROCEDURES AND STANDARDS IN THE TM CITED HEREON.										
8a. SIGNATURE (Person(s) performing inspection)			8b. TIME		8c. SIGNATURE (Maintenance Supervisor)			8d. TIME		9. MANHOURS REQUIRED
Arthur Sandlin SSG					1LT Jerry Reece					
TM ITEM NO. a	STATUS b	DEFICIENCIES AND SHORTCOMINGS c			CORRECTIVE ACTION d			INITIAL WHEN CORRECTED e		
6	/	Class II Leak upper radiator hose			Tighten clamps 473φ-φφ-2φ4-3491 2ca Pg 27-1 Fig 27 Item 1 Doc #7φ17-φφφ9			AS		
①	X	Transfer jumps out of gear			DA Form 24φ7 (Spt)			AS		

DA FORM 2404

Replaces edition of 1 Jan 84, which will be used

Notes:

<sup>1</sup> Administrative number/bumper number is entered in the upper right-hand corner or as prescribed by local SOP.

Legend for Figure 3-28;

completion instructions follow.

1. ORGANIZATION. Enter the name of the unit to which the equipment belongs.

2. NOMENCLATURE AND MODEL.

Figure 3-28. Sample DA Form 2404 used for maintenance services and inspections

- a. Enter the noun abbreviation and the model of the equipment.
- b. For watercraft, use the noun abbreviation and Hull Design Number.
- 3. REGISTRATION/SERIAL/NSN.
  - a. Enter the serial or registration number. Enter the NSN when no serial number or registration number is available.
  - b. For watercraft, enter the DA Hull Number.
  - c. For more than one item, leave blank.
- 4a. MILES. When a deficiency or a shortcoming is found or a service is performed, enter the miles or kilometers on the equipments odometer. Round to the nearest mile or kilometer. Enter the letter K before the number if the reading is in kilometers. Leave blank if the item does not have an odometer or if no faults are found.
- b. HOURS.
  - a. When a deficiency or a shortcoming is found or a service is performed, enter the hour meter reading.
  - b. Leave blank if hours do not apply to the equipment or if no faults are found.
- c. ROUNDS FIRED. Leave blank.
- d. HOT STARTS. Leave blank.
- 5. DATE. Enter the calendar date the service is performed.
- 6. TYPE INSPECTION.
  - a. Enter the type of inspection or service to be done (lubrication, monthly, quarterly, semiannual, and so on).
  - b. When doing more than one inspection or service at the same time, enter the service symbols in block 6 (for example, L/S).
- 7. APPLICABLE REFERENCE.
  - TM NUMBER, TM DATE.
    - a. Enter the number and date of the PMCS TM. When two TMs cover an item, enter the second TM number and date in the second number and date block.
    - b. When the manual has changes, print W/C and the latest change number after the TM number. Then, enter the latest change date in the TM date block.
  - 8a. SIGNATURE (*Person(s) performing inspection*). Personnel performing service/inspection signs and enters rank after inspection is completed.
  - 8b. TIME. Leave blank or use as needed locally.
  - 9a. SIGNATURE (*Maintenance Supervisor*). The maintenance supervisor or the commander's designated representative signs name and enters rank after service/inspection is completed.
  - 9b. TIME. Leave blank or use as needed locally. For missile systems and missile subsystems items reported under AR 700–138, chapter 4, enter the time when item was found to be NMC.
- 10. MANHOURS REQUIRED. Leave blank or use as needed locally.
- TM ITEM NO. a.
  - a. Enter the PMCS item number that applies to the fault listed in column c. If the PMCS has no item numbers, list the page, paragraph, or sequence number. Circle the number if the fault is listed in the Equipment not ready/available column or Not Mission Capable column of the PMCS. If the PMCS has no ready/available or NMC column, circle the TM item number, page, or paragraph number of any fault that makes the equipment NMC.
  - b. Pubs or TM sections other than PMCS may be required for safety faults or local dispatching. For example, AR 385–55 lists safety checks that may not be in the PMCS. Those faults are not counted as NMC for DA Form 2406 unless they are listed in the PMCS not ready column or the NMC column. But list them if a problem is found.
  - c. For those faults not covered by the PMCS, leave this column blank.
- STATUS b. Enter the status symbol that applies to the fault or deficiency.
- DEFICIENCIES AND SHORTCOMINGS c.
  - a. If a fault that can be repaired is found, stop the PMCS and correct the fault. Do not enter faults on DA Form 2404 that have been repaired. Continue the PMCS to ensure no other faults exist.
  - b. Briefly describe uncorrected faults.
- CORRECTIVE ACTION d.
  - a. Explain corrective action taken.
  - b. If parts are needed, the PLL clerk orders them and enters the document numbers.
  - c. Faults that need support maintenance go on a DA Form 2407. Print DA Form 2407 (SPT) in column d.
  - d. The commander's designated representative decides what maintenance can be delayed. Faults that do not affect the operation of the equipment and the operators safety can be deferred because
    - (1) Support is backed up and cannot get to the equipment right away.
    - (2) The needed repair part is not on hand.
    - (3) Other reasons at the COs discretion.
  - e. Faults that the commander's designated representative decides to defer go on DA Form 2408–14. Print DA Form 2408–14 in column d for those items.
- 10. INITIAL WHEN CORRECTED e. The mechanic initials any faults that have been fixed. The initials go on the last line for the entry in column d. The maintenance supervisor reviews the faults corrected and those still not fixed to decide what other action is needed. For quality control, the inspector or a designated representative checks all corrected status symbol X faults. The inspector then initials the status symbol.

**Figure 3–28. Sample DA Form 2404 used for maintenance services and inspections**

DATE: 20031205

EQUIPMENT MAINTENANCE AND INSPECTION WORKSHEET

DA FORM 5988-E

W33VT7

HQ 3D BN 7TH IN

EQUIPMENT DATA

ADMIN NUM: HQ903 EQUIP SERIAL NUM: 038537
EQUIP MODEL: M998 REGISTRATION NUM: NG2PZX
EQUIP NOUN: TRK UTL CGO 1.25T 4X4 TYPE INSPECTION: A
EQUIP NSN: 2320011077155 CURRENT READING: M 002239

PUBLICATION: TM 9-2320-280-10 NUMBER DATE CHANGE NUMBER
PUBLICATION: TM 9-2320-280-10-HR 01/96 03
05/99 00

INSPECTORS LIC #: R0986 TIME: 0915 SIGNATURE: [Signature] TIME: 1100

PARTS REQUESTED

Table with columns: FAULT DOC NUM, NIIN, NOUN, QTY, STATUS, DATE, COMP, P D, R L, I C. Rows include GASKET, SEAL PLAIN, PACKING, PR, FILTER ELE, GASKET.

MAINTENANCE FAULTS

Table with columns: ITEM NUM, FAULT DATE, FAULT STATUS, FAULT DESCRIPTION, CORRECTIVE ACTION, OPER HRS LIC #. Includes handwritten entry: (1) 20031205 (X) Engine smokes excessively (CLEARED FOR LIMITED USE - TRANSFER TO DSU [Signature] CPT)

Legend for Figure 3-29; completion instructions follow. EQUIPMENT DATA.

a. ADMIN NUM, EQUIP MODEL, EQUIPMENT NOUN, EQUIP NSN, EQUIP SERIEL NUM, REGISTRATION NUM, TYPE INSPECTION, CURRENT READING, and the PUBLICATION NUMBER (s) (with changes) are retrieved from the equipment data file. No entries from the operator/crew chief are needed in these areas.

Figure 3-29. Sample ULLS-generated DA Form 5988-E used for changing "X" condition

b. The operator/crew chief must ensure that data contained in these areas are correct prior to pulling PMCS. If any fields are not current, notify the ULLS operator so he/she can update the data fields through the ULLS Menu process. For more information about these data fields, refer to AISM 25-L3Q-AWC-ZZZ-EM.

TYPE INSECTION. Operator/crew chief requests the ULLS operator to print an Equipment Maintenance and Inspection Worksheet with the type inspection to be performed. See ULLS End User Manual or chapter 3 of this pamphlet for an explanation of these symbols.

a. Use the same worksheet for more than 1 day. If you find no faults during the BEFORE OPERATION checks in the PMCS, write the calendar date under the fault description column. If no faults are found DURING or AFTER OPERATION CHECKS, enter your initials in the initial column.

b. When no faults are found, this worksheet can be used for more than 1 day even if the worksheet was used for concurrent PMCSs; that is, W/M. Just place the first letter of the type of PMCS performed (W/M) under the corrective action column by that day's date in the fault description column.

INSPECTORS LIC #. The person performing the inspection enters his/her license number.

TIME: Enter the local time the inspection is performed.

SIGNATURE. When a deficiency or shortcoming is found, the operator or supervisor signs and enters rank. A signature in this block keeps the form from being used past current dispatch.

TIME. Leave blank or use as needed locally.

PARTS REQUESTED. The system checks the Document Control Register (DCR) and print any parts that have been ordered against the admin number on the worksheet. Operator/crew chiefs and supervisors review this section and take appropriate action as required. For more information about this section, see AISM 25-L3Q-AWC-ZZZ-EM.

FAULT. Shows the fault number for which the part is requested.

DOC NUM. The document number under which the required part has been ordered.

NIIN. National item identification number.

NOUN. Part nomenclature.

QTY DUE/REC. Due-in quantity for the part on order, and quantity received.

STATUS DATE. Shows date of status code.

DATE COMP. The date that all parts were received for document number listed or transaction closed.

PRI. The priority for item ordered.

DLC. Deadline code. "D" if deadlined; "N" if not deadlined.

MAINTENANCE FAULTS.

ITEM NUM.

a. Write the PMCS item number that applies to the fault listed in this column. If the PMCS has no item numbers, list the page, paragraph, or sequence number. Circle the number if fault is listed in the "Equipment is not ready/available if" column or "Not Mission Capable if" column of the PMCS. If the PMCS has no ready/available or not mission capable column, circle the TM item number, page, or paragraph number of any fault that makes equipment NMC.

b. Pubs or TM sections other than PMCS may be required for safety faults or local dispatching. For example, AR 385-55 lists safety checks that may not be in the PMCS. Those faults are not counted as NMC for Materiel Condition Status Report reporting unless they are in the PMCS "not ready" column or the not mission capable column. But, list them if a problem is found with one of them.

c. For those faults not covered by the PMCS, leave this column blank.

FAULT DATE. Enter the calendar date the deficiency or shortcoming was found.

FAULT STATUS. Enter the status symbol that applies to the fault or deficiency. Repair of status symbol X faults cannot be postponed or delayed, but they may be changed to circle X status symbol for limited operation. The commander or the commander's designated representative may change an X status symbol fault to a circle X status symbol. Changing of status symbols should only be done when the equipment is crucial to the mission. No X status symbol faults are changed to a circle X if it endangers the operator/crew or may cause further damage to the equipment. Circle X conditions are for one-time operation or mission (common sense must be used).

FAULT DESCRIPTION.

a. If a fault is found that can be repaired, stop the PMCS and correct the fault. Do not enter faults that have been repaired or already listed on the worksheet. Continue the PMCS to make sure no other faults exist.

b. Briefly describe fault. Skip one or two lines between faults. This gives maintenance room to note actions they take.

c. When more than one TM covers the equipment, draw a line under the last entry for one TM. Under the line, write the TM number of the manual to be used next. After the PMCS is finished and all the faults that cannot be fixed are listed, give the form to the maintenance supervisor.

CORRECTIVE ACTION. Explain corrective actions taken.

a. Print "Cleared for Limited Operations." Provide the specific limits under which equipment can be operated. For example, limits may involve speed, type of mission, distance, weather, or time. The change may affect a subsystem of a system listed in AR 700-138. If so, make sure limits include that part of the mission the system can no longer do.

b. Deficiencies changed to a circle X return to an X status symbol at the end of the day or mission.

c. Equipment cleared for limited operations are still carried as NMC for the Materiel Condition Status Reporting.

d. When a deficiency is corrected or changed to a circle X, enter the miles and calendar date in the corrective action column at the end of the dispatch or operation.

**Figure 3–29. Sample ULLS-generated DA Form 5988–E used for changing "X" condition**

OPER HRS/LIC #. Enter the number of hours expended to correct the fault. The mechanic enters his/her license number for any faults that have been fixed. The mechanic gives it back to the maintenance supervisor. Maintenance supervisor reviews the faults corrected and those still not fixed to decide what other action is needed. For quality control, the inspector or a designated representative checks all corrected status symbol X faults. The inspector then initials the status symbol.

Figure 3-29. Sample ULLS-generated DA Form 5988-E used for changing "X" condition

EQUIPMENT INSPECTION AND MAINTENANCE WORKSHEET											
For use of this form, see DA PAM 750-8 and 738-751; the proponent agency is DCS, G4											
1. ORGANIZATION Co B 1/3 Inf					2. NOMENCLATURE AND MODEL Trk Tractor M915A2					B608	
3. REGISTRATION/SERIAL/NSN NK0CPF			4a. MILES 16122		b. HOURS 1238		c. ROUNDS FIRED		d. HOT STARTS	e. DATE 18 Jan 97	6. TYPE INSPECTION PMCS
7. APPLICABLE REFERENCE											
TM NUMBER 9-2320-363-10 w/c3					TM DATE Nov 91						
COLUMN a - Enter TM item number.					COLUMN d - Show corrective action for deficiency or shortcoming listed in Column c.						
COLUMN b - Enter the applicable condition status symbol.					COLUMN e - Individual ascertaining completed corrective action initial in this column.						
COLUMN c - Enter deficiencies and shortcomings.											
STATUS SYMBOLS											
"X"-Indicates a deficiency in the equipment that places it in an inoperable status.					DIAGONAL "/"-Indicates a materiel defect other than a deficiency which must be corrected to increase efficiency or to make the item completely serviceable.						
CIRCLED "X"-Indicates a deficiency, however, the equipment may be operated under specific limitations as directed by higher authority or as prescribed locally, until corrective action can be accomplished.					LAST NAME INITIAL IN BLACK, BLUE-BLACK INK, OR PENCIL-Indicates that a completely satisfactory condition exists.						
HORIZONTAL DASH ("-")-Indicates that a required inspection, component replacement, maintenance operation check, or test flight is due but has not been accomplished, or an overdue MWO has not been accomplished.					FOR AIRCRAFT-Status symbols will be recorded in red.						
ALL INSPECTIONS AND EQUIPMENT CONDITIONS RECORDED ON THIS FORM HAVE BEEN DETERMINED IN ACCORDANCE WITH DIAGNOSTIC PROCEDURES AND STANDARDS IN THE TM CITED HEREON.											
8a. SIGNATURE (Person (s) performing inspection)				8b. TIME		9a. SIGNATURE (Maintenance Supervisor)		9b. TIME		10. MANHOURS REQUIRED	
SGT Jerry Driestam						Ira Whitehead CPT					
TM ITEM NO. a	STATUS b	DEFICIENCIES AND SHORTCOMINGS c				CORRECTIVE ACTION d				INITIAL WHEN CORRECTED e	
		17 Jan 97									
(34h)	X	Parking Brake does not work				Cleared for limited operations to transfer vehicle to maintenance on 18 Jan 97				JD	
(34h)	X	Parking Brake does not work									

DA FORM 2404  
1 APR 79

Replaces edition of 1 Jan 64, which will be used

Notes:

<sup>1</sup> Administrative/bumper number is placed in upper right hand corner or as prescribed by local SOP.

Legend for Figure 3-30;

completion instructions follow.

Figure 3-30. Sample DA Form 2404 used for changing "X" condition

1. ORGANIZATION. Enter the name of the unit to which the equipment belongs.
  2. NOMENCLATURE AND MODEL.
    - a. Enter the noun abbreviation and the model of the equipment.
    - b. For watercraft, use the noun abbreviation and Hull Design Number.
  3. REGISTRATION/SERIAL/NSN.
    - a. Enter the serial or registration number. Enter the NSN when no serial or registration number is available.
    - b. For watercraft, enter the DA Hull Number.
  - 4a. MILES. When a deficiency or a shortcoming is found, enter the miles or kilometers on the equipments odometer. Round to the nearest mile or kilometer. Enter the letter K if the reading is kilometers. Leave blank if the item does not have an odometer or if no faults are found.
  - b. HOURS.
    - a. When a deficiency or a shortcoming is found, enter the hour meter reading.
    - d. Leave blank if hours do not apply to the equipment or if no faults are found.
  - c. ROUNDS FIRED. Leave blank.
  - d. HOT STARTS. Leave blank.
  5. DATE. Enter the calendar date the deficiency or shortcoming was found.
  6. TYPE INSPECTION. Enter PMCS.
    - a. Use the same DA Form 2404 for more than 1 day. If no faults are found during the BEFORE OPERATION checks in the PMCS, enter the date in column c. If no faults are found DURING or AFTER OPERATION, initial in column e.
    - b. When no faults are found, this form can be used for more than 1 day even if the form was used for concurrent PMCSs, for example, W/M. Just place the first letter of the type of PMCS performed (W/M) in column d, by that days date in column c.
  7. APPLICABLE REFERENCE.
 

TM NUMBER, TM DATE.

    - a. Enter the number and date of the PMCS TM. When two TMs cover an item, enter the second TM number and date in the second number and date block.
    - b. When the manual has changes, print W/C and the latest change number after the TM number. Then enter the latest change date in the TM date block.
  - 8a. SIGNATURE (*Person(s) performing inspection*). When a deficiency or shortcoming is found, the operator or supervisor signs and enters rank. A signature in this block keeps the form from being used past the current dispatch.
  - 8b. TIME. Leave blank or use as needed locally.
  - 9a. SIGNATURE (*Maintenance Supervisor*). The commander or the commander's designated representative signs name and rank when making a status symbol change or changing from an X to a CIRCLED X status symbol for one time operation.
  - 9b. TIME. Leave blank or use as needed locally. For missile system and missile subsystems reported under AR 700-138, chapter 4, enter the time when item was found to be NMC.
  10. MANHOURS REQUIRED. Leave blank or use as needed locally.
- TM ITEM NO. a.
- a. Enter the TM item number that applies to the fault listed in column c. If the PMCS has no item numbers, list the page, paragraph, or sequence number. Circle the number if the fault is listed in the Equipment not ready/available if column or Not Mission Capable if column of the PMCS. If the PMCS has no ready/available or NMC column, circle the TM item number, page, or paragraph number of any fault that makes the equipment NMC.
  - b. Pubs or TM sections other than PMCS may be required for safety faults or local dispatching. For example, AR 385-55 lists safety checks that may not be in the PMCS. Those faults are not counted as NMC for the Materiel Condition Status Report (MCSR) unless they are in the PMCS not ready column or the NMC column. But, list them if a problem is found with one of them.
  - c. For those faults not covered by the PMCS, leave this column blank.
- STATUS b. Repair of status symbol X faults cannot be postponed or delayed, but they may be changed to a CIRCLED X status symbol for limited operation. The commander or the commander's designated representative may change an X status symbol fault to a CIRCLED X status symbol. Changing of status symbols should only be done when the equipment is crucial to the mission. No X status symbol faults are changed to a CIRCLED X if it endangers the operator/crew or causes further damage to the equipment. CIRCLED X conditions are for one-time operation or mission. (Common sense must be used.)
- DEFICIENCIES AND SHORTCOMINGS c.
- a. If a fault that can be repaired is found, stop the PMCS and correct the fault. Do not enter faults that have been repaired on DA Form 2404. Continue the PMCS to make sure no other faults exist.
  - b. Briefly describe the fault. Skip one or two lines between faults. This gives maintenance room to note actions taken.
  - c. When more than one TM covers the equipment, draw a line under the last entry for one TM. Under the line, write the TM number of the manual to be used next. After the PMCS is finished and all faults that cannot be fixed are listed, give the form to the maintenance supervisor.
- CORRECTIVE ACTION d.
- a. Print Cleared for limited operations, and the specific limits under which the equipment can be operated. For example, limits may involve speed, type of mission, distance, weather, or time. The change may affect a subsystem of a system listed in AR 700-138. If so, make sure the limits include the part of the mission the system can no longer do.
  - b. Deficiencies changed to a CIRCLED X return to an X status symbol at the end of the day or mission.

**Figure 3-30. Sample DA Form 2404 used for changing "X" condition**





2. NOMENCLATURE AND MODEL.

- a. Enter the noun abbreviation and the model of the equipment.
- b. For watercraft, use the noun abbreviation and Hull Design Number.

3. REGISTRATION/SERIAL/NSN. Enter the serial or registration number. Enter the NSN when no serial or registration number is available. For watercraft, enter the DA Hull Number.

4a. MILES. Enter the miles or kilometers on the equipments odometer as of the date in block 5. Round to the nearest mile or kilometer. Enter the letter K before the number if the reading is kilometers. Leave blank if the item does not have an odometer.

b. HOURS.

1. Enter the hour meter reading in hours as of the date in block 5.

2. Leave blank if hours do not apply to the equipment.

c. ROUNDS FIRED. Leave blank.

d. HOT STARTS. Leave blank.

5. DATE. Enter the calendar date.

6. TYPE INSPECTION. Enter the letters BDAR.

7. APPLICABLE REFERENCE.

TM NUMBER, TM DATE.

a. Enter the number and date of the PMCS TM. When two TMs cover an item, enter the second TM number and date in the second TM number and date block.

b. When the manual has changes, print W/C and the latest change number after the TM number. Then, enter the latest change date in the TM date block.

8a. SIGNATURE (*Person(s) performing inspection*). Leave blank if the item does not have an odometer. When the repair or replacement has been accomplished, the person doing the job signs name and enters rank.

8b. TIME. Leave blank or use as needed locally.

9a. SIGNATURE (*Maintenance Supervisor*). The maintenance supervisor or the commander's designated representative signs name and enters rank. This is to ensure that when corrective actions are taken, no safety faults still exist that would endanger the operator or cause further damage to the equipment.

9b. TIME. Leave blank or use as needed locally.

10. MANHOURS REQUIRED. Leave blank or use as needed locally.

TM ITEM NO. a. Leave blank.

STATUS b. Leave blank.

DEFICIENCIES AND SHORTCOMINGS c. Briefly describe the fault. If more than one deficiency or shortcoming is noted, leave enough room between entries to allow for corrective action taken to be annotated.

CORRECTIVE ACTION d. Explain actions taken to correct or repair the fault. Note any parts replaced, parts ordered, and work done.

INITIAL WHEN CORRECTED e. The person making the corrective action initials here.

**Figure 3–31. Sample DA Form 2404 used for BDAR**

---

EQUIPMENT INSPECTION AND MAINTENANCE WORKSHEET						
For use of this form, see DA PAM 750-8 and 738-751; the proponent agency is DCS, G4						
1. ORGANIZATION 132 QM CO (WS)			2. NOMENCLATURE AND MODEL TRK CAR LMTY W/O WN M1078			
3. REGISTRATION/SERIAL/NSN NH0AB4	4a. MILES 3650	b. HOURS 249	c. ROUNDS FIRED	d. HOT STARTS	e. DATE 31 JAN 97	6. TYPE INSPECTION ECOD
7. APPLICABLE REFERENCE						
TM NUMBER 9-2320-365-20		TM DATE OCT 95		TM NUMBER 9-2320-365-24P		TM DATE FEB 96
COLUMN a - Enter TM item number.			COLUMN d - Show corrective action for deficiency or shortcoming listed in Column c.			
COLUMN b - Enter the applicable condition status symbol.			COLUMN e - Individual ascertaining completed corrective action initial in this column.			
COLUMN c - Enter deficiencies and shortcomings.						
STATUS SYMBOLS						
"X"-Indicates a deficiency in the equipment that places it in an inoperable status.			DIAGONAL "(/)"-Indicates a materiel defect other than a deficiency which must be corrected to increase efficiency or to make the item completely serviceable.			
CIRCLED "X"-Indicates a deficiency, however, the equipment may be operated under specific limitations as directed by higher authority or as prescribed locally, until corrective action can be accomplished.			LAST NAME INITIAL IN BLACK, BLUE-BLACK INK, OR PENCIL-Indicates that a completely satisfactory condition exists.			
HORIZONTAL DASH "-"-Indicates that a required inspection, component replacement, maintenance operation check, or test flight is due but has not been accomplished, or an overdue MWO has not been accomplished.			FOR AIRCRAFT-Status symbols will be recorded in red.			
ALL INSPECTIONS AND EQUIPMENT CONDITIONS RECORDED ON THIS FORM HAVE BEEN DETERMINED IN ACCORDANCE WITH DIAGNOSTIC PROCEDURES AND STANDARDS IN THE TM CITED HEREON.						
8a. SIGNATURE (Person performing inspection) Richard A. Trendera RICHARD A. TRENDA, SFC 3662 MCH E (-) 662-0408		8b. TIME	8c. SIGNATURE (Maintenance Supervisor) Robert D. Edkins ROBERT D. EDKINS, MSG 3662 MCH E (-) 662-0355		8d. TIME	8e. MANHOURS REQUIRED
TM ITEM NO. a	STATUS b	DEFICIENCIES AND SHORTCOMINGS c		CORRECTIVE ACTION d		INITIAL WHEN CORRECTED e
	STEP 1	TECHNICAL INSPECTION				
1	/	RIGHT FRONT FENDER CRUSHED		REPLACE		2.0
2	/	WINDSHIELD CRACKED		REPLACE		2.3
3	/	FRONT BUMPER TWISTED		REPLACE		4.0
4	/	FUEL TANK DENTED		REPLACE		1.5
5	/	RIGHT CAB STEP CRUSHED		REPLACE		1.0
6	/	RIGHT CAB DOOR BENT		REPLACE		5.0
7	/	CAB DENTED RIGHT REAR		REPAIR		3.5
8	/	RIGHT MIRROR BRACKET BENT		REPAIR		.3
	2	DATE OF MANUFACTURE :		1994		
	3	TIME SINCE NEW :		3650		
	4	OUTSTANDING MODIFICATION		WORK ORDERS : NONE		
	5	TOTAL MAN-HOURS TO REPAIR :		19.6 HRS		
	6	TOTAL MAN-HOUR COST :		19.6 x 28.43		557.23
	7	MAINTENANCE EXPENDITURE		Limits : TB 43-0002-81		
	8	REPAIR COST FACTOR :		71%		
	9	REQUIRED REPLACEMENT PARTS:				
		NSN	NOUN	QTY	COST	
		2510-01-390-3730	FENDER, VEH	1EA	389.19	

DA FORM 2404  
1 APR 79

Replaces edition of 1 Jan 64, which will be used

Figure 3-32. Sample DA Form 2404 used for ECOD (front)



- c. ROUNDS FIRED. Enter the rounds fired as of the date in block 5. Leave blank if rounds fired does not apply to the equipment.
- d. HOT STARTS. Leave blank.
- 5. DATE. Enter the calendar date.
- 6. TYPE INSPECTION. Enter the letters ECOD.
- 7. APPLICABLE REFERENCE.

TM NUMBER, TM DATE.

- 1. Enter the number and date of the PMCS TM. When two TMs cover an item, enter the second TM number and date in the second TM number and date block.
- 2. When the manual has changes, print W/C and the latest change number after the TM number. Then, enter the latest change date in the TM date block.
- 8a. SIGNATURE (*Person(s) performing inspection*). Enter the name, rank, duty phone number, signature, and organization of the inspector preparing DA Form 2404.
- 8b TIME. Leave blank or use as needed locally.
- 9a. SIGNATURE (*Maintenance Supervisor*). Enter name, grade, signature, and organization of the maintenance/motor officer or commanders authorized representative.
- 9b. TIME. Leave blank or use as needed locally.
- 10. MANHOURS REQUIRED. Leave blank or use as needed locally.

In columns a, b, c, d, and e, enter required information as instructed in the following steps. If additional space is required, use an additional DA Form 2404. Enter Step 1. Print Technical Inspection.

TM ITEM NO. a Enter the fault number.

STATUS b. Enter the status symbol that applies to the fault.

DEFICIENCIES AND SHORTCOMINGS c. Enter each fault detected during the technical inspection that requires repair or replacement to restore equipment serviceability.

CORRECTIVE ACTION d. Enter the maintenance action (repair or replace) required to correct the fault entered in column c.

INITIAL WHEN CORRECTED e. Enter the man-hours required to correct the fault identified in column c.

- 1. Enter Step 2. Print Date of Manufacture followed by the date the equipment was manufactured as shown on the equipment data plate or the date entered in block 11 of the items DA Form 2408-9.
- 2. Enter Step 3. Print Time Since New followed by the total (cumulative) miles or kilometers and hours on the equipment.
- 3. Enter Step 4. If an outstanding modification work order has not been applied to the equipment, print Outstanding Modification Work Orders. List all applicable modifications that have not been accomplished. Next to each modification, enter the man-hours required to apply the MWO.
- 4. Enter Step 5. Print Total Man-hours to Repair followed by the total estimated man-hours required to restore the equipment serviceability.
- 5. Enter Step 6. Print Total Man-hour Cost. In column d, enter total hours required to do the repair multiplied by the current local labor rate. In column e, enter total dollar cost.
- 6. Enter Step 7. Enter Maintenance Expenditure Limits followed by the number and date of the applicable TB.
- 7. Enter Step 8. Print Repair Cost Factor followed by the repair cost factor (percentage and dollar factor, if applicable) cited in the TB listed in step 7.
- 8. Enter Step 9. Print Required Replacement Parts followed by a listing of the parts (NSN, noun, qty, and cost) required to replace/repair the item.
- 9. Enter Step 10. Print Total Cost of Replacement Parts followed in column e by the total cost of required replacement parts (Total of Step 9).
- 10. Enter Step 11. Print Total Cost of Repairs followed by the total Step 6 and Step 10 entries. Enter total in column e.

**Figure 3-32. Sample DA Form 2404 used for ECOD (back)**







Legend for Figure 3-35;

completion instructions follow.

WORK ORDER NUMBER. Enter the ORG WON from DA Form 2407 or SAMS or ULLS.

EQUIP. Enter the noun abbreviation.

USA SER NO. Enter the equipment serial number, registration number, or other identifying number.

LOCATION. The person preparing the form enters the initial location of the equipment. As the equipment moves, the person receiving the equipment for work enters the new location.

SECTION. The mechanic who receives the equipment enters his or her section identification.

MECHANIC. The mechanic performing the work enters his or her initials.

DATE. Enter the ordinal date the equipment moved into the section.

Figure 3-35. Sample DA Form 3999-4

---

DATE: 20020822	MAINTENANCE REQUEST	DA FORM 5990-E
----- CUSTOMER DATA -----		
UIC: W33U1C	D TROOP, 6TH CBAC	PHONE: (601)723-7834
UTIL CODE: 0		
----- ACTIVITY DATA -----		
SUP WON:	D CO 703RD MAINT BN	PHONE: 723-1245
SUP UIC: WM4DRA		SHOP SEC:
----- EQUIPMENT DATA -----		
TYPE MNT REQ: 1	ID: A NSN: 2320000771619	MODEL: M36A2
NOUN: TRK CGO 2 1/2T	SER NUM: A2233	QTY: 00001
ORG WON: 33U1C1200098	PRIORITY: 12	FAILURE DETECTED: D
MI/KM: -----	HOURS: -----	ROUNDS:
IN WARRANTY:	LEVEL OF WORK: F	ADMIN NUM:
DEFICIENCY: BO DRIVE DEFECTIVE		
PD AUTHENTICATING SIGNATURE:		
----- SIGNATURE DATA -----		
SUBMITTED BY: _____	ORD DATE: _____	MIL TIME: _____
ACCEPTED BY: _____	STATUS: ___	ORD DATE: _____
		MIL TIME: _____
----- ACTION DATA -----		
WORK STARTED BY: _____	STATUS: ___	ORD DATE: _____
		MIL TIME: _____
INSPECTED BY: _____	STATUS: ___	ORD DATE: _____
		MIL TIME: _____
PICKED UP BY: _____	STATUS: ___	ORD DATE: _____
		MIL TIME: _____
----- COMPLETION DATA -----		
QTY RPR: _____	QTY CONDEMNED: _____	NRTS: _____
EVAC WON: _____	EVAC UNIT NAME: _____	

Legend for Figure 3-36;

completion instructions follow.

CUSTOMER DATA. Displays all ULLS-generated unit information.

UIC. Displays the UIC and unit name of the unit submitting the work request.

UNIT NAME. Displays the unit name submitting the work request.

Figure 3-36. Sample ULLS-generated DA Form 5990-E



PHONE. Displays the phone number of the unit submitting the request.

UTIL CODE. Displays the utilization code of the equipment item that is being submitted for maintenance support.

ACTIVITY DATA. Displays all support activity data.

SUP WON. Blank. Support work order number is assigned by support maintenance activity.

UNIT NAME. ULLS-generated name of maintenance activity. Self-explanatory.

PHONE. ULLS generated; self-explanatory.

SUP UIC. The support maintenance activity's UIC.

SHOP SEC. Blank. Assigned by support maintenance activity.

EQUIPMENT DATA:

TYPE MNT REQ. ULLS operator enters alpha/numeric code that identifies the type of maintenance required on an item of equipment. For a definition of the codes, see the ULLS EM.

ID. The identifying number code that identifies whether the equipment is for an NSN, part number, or other numbers.

NSN. The National Stock Number or other number for the equipment.

MODEL. Self-explanatory.

NOUN. Self-explanatory.

SER NUM. Serial Number. Self-explanatory.

QTY. Quantity. Enter the number of items on the work request.

ORG WON. The ULLS generated organizational work order number.

PRIORITY. The ULLS operator enters the priority designator (PD) for the request. Assign PDs based on the urgency of need designator and Force Activity Designator. AR 750-1, AR 710-2, and AR 725-50 cover assignment of PDs.

FAILURE DETECTED. For values and explanation, see, table B-3, or the ULLS EM.

MI/KM. The miles/kilometers recorded within ULLS.

HOURS. If applicable; ULLS generated entry.

ROUNDS. If applicable; manual entry.

IN WARRANTY. ULLS-generated entry. Y if under warranty; N if not under warranty.

LEVEL OF WORK. ULLS-generated entry.

ADMIN NUM. ULLS-generated based on ULLS operator input.

DEFICIENCY. The ULLS operator enters a brief description of the malfunction or symptom.

PD AUTHENTICATING SIGNATURE. The CO or the CO's designated representative signs for all priority 01 through 10 requests. The signature approves the use of the PD.

SIGNATURE DATA:

SUBMITTED BY. The person submitting the request signs on this line.

ORD DATE. The person submitting this request enters the ordinal date; for example, 10 Feb 04 would be entered as 04041.

MIL TIME. Enter the Military time the maintenance request was accepted.

ACCEPTED BY. The person receiving the request at support maintenance signs on this line.

STATUS. The person who signs the Accepted by annotates an initial inspection status. Table B-12 lists work request status codes (STA).

ORD DATE. The person receiving this request at support maintenance enters the ordinal date; for example, 10 Feb 04 would be entered as 04041.

MIL TIME. Enter the Military time the maintenance request was accepted.

ACTION DATA. Support Maintenance fills out the following blocks:

WORK STARTED BY. The person assigned to do the work reflected on the maintenance request signs on this line.

STATUS. The person who signs the Work Started By annotates completion status. Table B-12, lists work request status codes (STA).

ORD DATE. Annotate in the space provided.

MIL TIME. Annotate in the space provided.

INSPECTED BY. The person inspecting the equipment signs on this line.

STATUS. Annotate the work request status code that applies.

ORD DATE. Annotate in the space provided.

MIL TIME. Annotate in the space provided.

PICKED UP BY. The person picking up the equipment signs on this line.

STATUS. Always annotate U (pickup).

ORD DATE. Annotate in the space provided.

MIL TIME. Annotate in the space provided.

COMPLETION DATA:

QTY RPR. The support maintenance activity annotates the quantity of items repaired.

QTY CONDEMNED. The support maintenance activity annotates the quantity of items condemned.

NRTS. The support maintenance activity annotates the quantity of items not repairable this station.

EVAC WON. If item is evacuated, the work order number assigned by the receiving activity is annotated on this line.

EVAC UNIT NAME. Annotate the name of the unit to whom the equipment is evacuated.

**Figure 3-36. Sample ULLS-generated DA Form 5990-E**

MAINTENANCE REQUEST For use of this form, see DA PAM 750-8 and 738-751; the proponent agency is DCS, G4			PAGE NO	NO OF PAGES	REQUIREMENT CONTROL SYMBOL CSGLD-1047(R1)
SECTION I - CUSTOMER DATA			SECTION II - MAINTENANCE ACTIVITY DATA		
1a. UIC CUSTOMER WYDZAA	1b. CUSTOMER UNIT NAME HQ	1c. PHONE NO 113 INF 273-9131	3a. WORK ORDER NUMBER (WON)	3b. SHOP	3c. PHONE NO
2a. SAMS-2 UIC/SAMS-ITDA	2b. UTILIZATION CODE Φ	2c. MCSR Y	4a. UIC SUPPORT UNIT	4b. SUPPORT UNIT NAME	
SECTION III - EQUIPMENT DATA					
5. TYPE MNT REQ CODE 1	6. ID A	7. NSN 2320013601892	15a. FAILURE DETECTED DURING/WHEN DISCOVERED CODE (Enter code) See DA Pamphlets 738-750 and 738-751 A		
8. MODEL M1089	9. NOUN Trk Tractor MTV W/Wk		15b. FIRST INDICATION OF TROUBLE/HOW RECOGNIZED CODE (Enter Code) See DA Pamphlets 738-750 and 738-751		16. MILES/KILOMETERS/HOURS/ROUNDS M 1430 K
10a. ORG WON/DOC NO YDZAA 70321	10b. EIC BITZ		17. PROJECT CODE 387		18. ACCOUNT PROCESSING CODE H 106 R
11. SERIAL NUMBER T029888	12. QTY 01	13. PD 03	19. IN WARRANTY? (enter Y or N)	20. ADMIN NO N AB10	
14. MAJ. FUNCTION DESCRIPTION (for DSU, GSU/AVIM, DEPOT use)			21. REIMBURSABLE CUSTOMER (if Intransit customer enter Y or N)	22. LEVEL OF WORK F	
24. DESCRIBE DEFICIENCIES OR SYMPTOMS ON THE BASIS OF COMPLETE CHECKOUT AND DIAGNOSTIC PROCEDURES IN EQUIPMENT TM (Do not prescribe repairs)			23. SIGNATURE Chad Anthony		
25. REMARKS Vehicle lacks power					
PREPARATION INSTRUCTIONS FOR THIS PAGE					
<p><b>SECTION I</b></p> <p>Block 1a. Enter UIC of submitting organization. Block 1b. Enter name of submitting organization. Block 1c. Enter number to be called when maint. is completed. Block 2a. Enter UIC of supporting SAMS-2/SAMS-ITDA if work is requested while intransit and away from your support maintenance unit. Block 2b. Enter utilization code. See DA Pamphlets 738-750 and 738-751. Block 2c. Enter "Y" if reportable under AR 700-138. If not, leave blank.</p> <p><b>SECTION II</b></p> <p>Leave blank. To be completed by the support maintenance DSU/GSU/AVIM/DEPOT.</p> <p><b>SECTION III</b></p> <p>Block 5. Enter the Type Maintenance Request Code. See DA Pamphlets 738-750 and 738-751. Block 6. Enter ID associated with block 7. See DA Pamphlets 738-750 and 738-751. Block 7. Enter the NSN or stock number of the item being submitted. Block 8. Enter model of item being submitted. Block 9. Enter noun/nomenclature of item being submitted. Block 10a. Enter Work Order Number (WON)/DOC NO assigned when item is submitted. Otherwise, leave blank. Block 10b. Enter End Item Code. See AMDF. Block 11. Enter serial number of item being submitted.</p>			<p><b>SECTION III (Cont'd)</b></p> <p>Block 12. Enter the quantity of items being submitted. Block 13. Enter the maintenance priority designator determined from DA PAM 710-2-1. Block 14. For DSU, GSU/AVIM, DEPOT use. Block 15a. Enter the code that most accurately describes when the fault or deficiency was detected. See DA Pamphlets 738-750 and 738-751. Block 15b. Select one. Enter the code. See DA Pamphlets 738-750 and 738-751. Block 16. Enter the accumulated usage data in blocks, when equipment is subject to usage reporting. Block 17. Enter the project code if one has been assigned. If not, leave blank. Block 18. See DA Pamphlets 738-750 and 738-751. Block 19. Enter "Y" or "N" to indicate whether equipment is still under manufacturer's warranty. Block 20. Enter the admin number assigned for property control purposes for the equipment being submitted. Block 21. For DSU/GSU/AVIM/Depot use. Block 22. Enter level of work performed "O" for UNIT LEVEL/AVUM, "F" for DSU/AVIM, "H" for GSU, "D" for DEPOT, "K" for contractor or "L" for Spc Rpr Act. Block 23. Enter the signature of the CO or the CO's designated representative when the priority designator is 01-10. For priority designators 11-15, leave blank. Block 24. Enter a brief description of the deficiencies or symptoms that you feel require attention at this level of maint. Block 25. Self-explanatory.</p>		
34a. SUBMITTED BY C. Anthony	35a. ACCEPTED BY	35c. DATE	<p>Block 34a. Enter first initial and last name of submitter. Block 34b. Enter ordinal date submitted (YYDDD). Block 35a. Enter first initial and last name of person accepting maint. request. Block 35b. Enter the initial status. See DA Pamphlets 738-750 and 738-751. Block 35c. Enter ordinal date accepted (YYDDD). Block 35d. Enter military time.</p>		
34b. DATE 9.7027	35b. STATUS	35d. TIME			

DA FORM 2407, JUL 94

PREVIOUS EDITIONS OF DA FORM 2407 AND DA FORM 5504 ARE OBSOLETE

RECEIPT COPY 1

Legend for Figure 3-37;  
completion instructions to request support maintenance follow.

Figure 3-37. Sample DA Form 2407 used to request support maintenance

SECTION I—CUSTOMER DATA. Blocks 1, 5, 6, 7, 10a, 10b, 11, 12, 13, 15, 16, 20, and 24 are mandatory if equipment is inoperative. Inoperative equipment is equipment that is NMC, in accordance with AR 700–138, a subsystem of a reportable weapon system, or command maintenance significant.

1a. UIC CUSTOMER. Enter the UIC of the customer that owes the equipment.

1b. CUSTOMER UNIT NAME. Enter the name of the unit identified by the UIC in block 1a.

1c. PHONE NO. Enter the phone number of the unit identified by the UIC in block 1a.

2a. SAMS–2 UIC/SAMS–1/TDA. If in transit, enter UIC for SAMS–2 or SAMS–1/TDA unit.

2b. UTILIZATION CODE. Enter Utilization Code. See appendix B.

2c. MCSR. Print the word yes or the letter Y if the item is reported under AR 700–138. This applies to components and subsystems of an item/system that is reportable. If not, leave this block blank.

SECTION II—MAINTENANCE ACTIVITY DATA. To be completed by support maintenance DSU/AVIM/DEPOT.

SECTION III—EQUIPMENT DATA.

5. TYPE MNT REQ CODE. Enter the type Maintenance Request Code. Table B–20 lists the codes.

6. ID. Enter the Identification (ID) Code shown below that identifies the type of number to be entered in block 7: A—National/NATO Stock Number, C—Manufacturers Code and Reference Number (Part Number), D—Management Control Number (MCN), P—Other Numbers.

7. NSN. Enter the NSN or appropriate number identified in block 6 of the item being repaired (for example, engine of truck).

8. MODEL. Enter model number.

9. NOUN. Enter noun nomenclature of item.

10a. ORG WON/DOC NO. Enter organization work order number or organization document number. For assignment of the ORG WON, see paragraph 3–4.

10b. EIC. Enter the end item code (EIC) of the primary item. See Army Master Data File (AMDF).

11. SERIAL NUMBER.

a. Enter the serial number of the item shown block 9.

b. For nontactical-wheeled vehicles, use the registration number.

c. For ammunition, use the lot number.

d. Leave blank if the form is used for more than one item.

e. Leave blank if equipment has more than one serial number.

f. Mandatory entry if equipment is inoperative.

12. QTY. Enter the number of items. (Must be only one item listed if equipment is reportable under AR 700–138 and is NMC.)

13. PD. Enter the Priority Designator. (See AR 750–1, para 3–7.)

14. MALFUNCTION DESCRIPTION (for DSU, GSU/AVIM, DEPOT use). Failure detected during/when discovered code.

15a. FAILURE DETECTED DURING/WHEN DISCOVERED CODE (Enter code). Failure detected during from table B–3; when discovered code from DA Pam 738–751. Leave blank if no failure occurred.

15b. FIRST INDICATION OF TROUBLE/HOW RECOGNIZED CODE (Enter code). Enter first indication of trouble code from table B–4 or how recognized code from DA Pam 738–751.

16. MILES/KILOMETERS/HOURS/ROUNDS. Enter the miles or kilometers from the odometer on the equipment beside the M or K. Round to the nearest mile or kilometer. If the equipment has no odometer, leave blank. Enter the hour reading (to the nearest hour) beside the H from the hour meter mounted on the equipment. If the equipment has no meter, leave blank. Enter the total equivalent full charge (EFC) rounds fired beside the R. See the items DA Form 2408–4. If rounds do not apply to the equipment, leave blank.

17. PROJECT CODE (if assigned). Enter the project code if one has been assigned. If not, leave blank.

18. ACCOUNT PROCESSING CODE. Enter the account processing code (APC) if required by the unit. The APC is a code prescribed locally for costing and budget identification of customers and organizations. If not required, leave blank.

19. IN WARRANTY? Enter Y or N to indicate whether equipment is still under manufacturers warranty. If Y, submit one work request for each serial numbered item.

20. ADMIN NUMBER. Enter the bumper number/materiel control number, or administrative number assigned to the item of equipment.

21. REIMBURSABLE CUSTOMER (if Intransit customer enter Y or N). For DSU/GSU/AVIM/Depot use.

22. LEVEL OF WORK. Enter code for level of work from table B–24.

23. SIGNATURE. The commander or the commander's designated representative signs for all priority 01 through 10 requests. This signature approves the use of the PD.

24. DESCRIBE DEFICIENCIES OR SYMPTOMS ON THE BASIS OF COMPLETE CHECKOUT AND DIAGNOSTIC PROCEDURES IN EQUIPMENT TM (Do not prescribe repairs).

1. Using the information from DA Form 5988–E or DA Form 2404, briefly describe the fault or symptoms. For example, Print Engine does not develop full power or Equipment uses two quarts of oil daily. Do not ask for general or specific repair of parts to be replaced; for example, do not tell support to replace the hydraulic system or repair as needed.

2. When the form is asking for work on more than one item with the same NSN, list the number of items, their serial numbers (if they have serial numbers), and anything else support needs. Inoperative equipment (equipment reported on the Materiel Condition Status Report), components/subsystems of reportable equipment, or command maintenance significant equipment) must have its own separate forms.

**Figure 3–37. Sample DA Form 2407 used to request support maintenance**

3. When the form is for components or assemblies with a recoverability code of A, D, F, H, or L, give the end item NSN. Enter the NSN on the last line of block 25. Recoverability codes are found in the recoverability code column on the Army Master Data File (AMDF). The codes are also listed as part of the items source, maintenance, and recoverability code in the parts manual. If more room is needed, use a DA Form 2407-1. When the form is requesting standard repair after a battle-damage expedient repair has been applied, print BDAR in bold letters before describing the fault or symptoms.

REMARKS. Use as needed.

34a. SUBMITTED BY. The person sending in DA Form 2407 enters first initial and last name in this block.

34b. DATE. The person signing the forms enters the original ordinal date the form was given to support.

35a-35d. To be completed by the supporting DSU.

**Figure 3-37. Sample DA Form 2407 used to request support maintenance**

---

MAINTENANCE REQUEST For use of this form, see DA PAM 738-750 and 738-751; the proponent agency is DCSLOG				PAGE NO	NO OF PAGES	REQUIREMENT CONTROL SYMBOL CSGLD-1047(R1)								
SECTION I - CUSTOMER DATA				SECTION II - MAINTENANCE ACTIVITY DATA										
1a. UIC CUSTOMER WX3BFC	1b. CUSTOMER UNIT NAME 42D MAINT CO	1c. PHONE NO 273-931	3a. WORK ORDER NUMBER (WOM) CDRAA9400022		3b. SHOP A	3c. PHONE NO 272-4003								
2a. SAMS-2 UIC/SAMS-ITDA		2b. UTILIZATION CODE Ø	2c. MCSR Y	4a. UIC SUPPORT UNIT W.C.D.R.A.A		4b. SUPPORT UNIT NAME A CO, 710th MAINT BN								
SECTION III - EQUIPMENT DATA														
5. TYPE MNT REQ CODE A	6. ID A	7. NSN 2320014928224		15a. FAILURE DETECTED DURING/WHEN DISCOVERED CODE (Enter code) See DA Pamphlets 738-750 and 738-751			15b. FIRST INDICATION OF TROUBLE/HOW RECOGNIZED CODE (Enter Code) See DA Pamphlets 738-750 and 738-751							
8. MODEL M984A2		9. NOUN TRUCK, WRECKER 10 TON		16. MILES/KILOMETERS/HOURS/ROUNDS RECOGNIZED CODE (Enter Code) See DA Pamphlets 738-750 and 738-751			M	52310	K					
10a. ORG WORN/DOC NO X3BFCØ20001		10b. EIC B2X		Ø77			H	712	R					
11. SERIAL NUMBER 4214		12. QTY 1	13. PD 2	17. PROJECT CODE (if assigned)		18. ACCOUNT PROCESSING CODE		19. IN WARRANTY (enter Y or N)						
14. MALFUNCTION DESCRIPTION (for DSU, GSUIAVIM, DEPOT use)				21. REIMBURSABLE CUSTOMER (if intransit customer enter Y or N)		22. LEVEL OF WORK F		23. SIGNATURE Mar Carlson						
24. DESCRIBE DEFICIENCIES OR SYMPTOMS ON THE BASIS OF COMPLETE CHECKOUT AND DIAGNOSTIC PROCEDURES IN EQUIPMENT TM (Do not prescribe repairs)														
REQUEST ECOD														
25. REMARKS TOTAL COST OF ECOD \$821.36														
26. TECHNICAL REFERENCES TM 9-2320-279-34 B P TM 9-2320-357-246 P														
SECTION IV - TASK REQUIREMENTS DATA														
27a. FILE INPUT ACT CD	27b. TASK NO	27c. ACT CODE	27d. TASK DESCRIPTION		27e. QTY TO BE RPR	27f. WORK CENTER	27g. FAILURE CODE	27h. MH PROJ	27i. MH EXP					
A	I1	F	INITIAL INSPECTION			INSP	717	65	65					
A	I3	A	CHECK DAMAGED AREA			INSP	717	2	2					
A	I7	G	FINAL INSPECTION			INSP	717	65	65					
SECTION V - PART REQUIREMENTS														
28a. FILE INPUT ACT CD	28b. TASK ID NO	28c. ID NO	28d. NSN OR PART NUMBER		28e. SFK CD	28f. QTY REQ	28g. QTY ISSUED	28h. NMCS CD	28i. FAILURE CODE	28j. STORAGE LOCATION	28k. INITIALS	28l. COST \$		
28m. TOTAL MANHOURS 20														
28n. TOTAL MANHOURS COSTS \$				170.00				28o. TOTAL PARTS COSTS \$ 651.36						
SECTION VI - COMPLETION DATA														
29. QTY RPR			30. QTY CONDEMN			31. QTY NRTS			32. EVAC WON			33. EVAC UNIT NAME		
SECTION VII - ACTION SIGNATURES														
34a. SUBMITTED BY L Daniels		35a. ACCEPTED BY J Spener		35c. DATE 04212		36a. WORK STARTED BY S Geage		37a. INSPECTED BY J Spener		38a. PICKED UP BY L Daniels				
34b. DATE 04210		35b. STATUS A		35d. TIME 1900		36b. STATUS E		36c. DATE 04212		36d. TIME 1400		37b. STATUS F		
37c. DATE 04212		37d. TIME 1630		38b. STATUS U		38c. DATE 04212		38d. TIME 0800						

DA FORM 2407, JUL 94

NMP COPY 2

Legend for Figure 3-38;  
completion instructions follow for estimated cost of damage (ECOD).  
PAGE NO. Enter the page number when all needed entries are in Sections IV-VII. Enter page numbers as required.  
NO OF PAGES. Enter the total number of pages used when entries are in Sections IV-VII. Enter page numbers as required.  
SECTION I—CUSTOMER DATA. The unit requesting the support maintenance fills in this section.  
SECTION II—MAINTENANCE ACTIVITY DATA.

Figure 3-38. Sample DA Form 2407 used for ECOD

3a. WORK ORDER NUMBER (WON). Enter WON (see paragraph 3–4c for assignment of WONs).

3b. SHOP. Enter shop section code. These codes are assigned to uniquely identify a particular maintenance shop section. Each maintenance battalion operating SAMS assigns codes A through Z locally. Examples include A—automotive shop, B—battery shop, and C—communications shop.

3c. PHONE NO. Enter the phone number of the maintenance activity.

4a. UIC SUPPORT UNIT. Enter the UIC of the maintenance activity.

4b. SUPPORT UNIT NAME. Enter the unit name of the maintenance activity.

SECTION III—EQUIPMENT DATA. Items 5–13 and 15–23 to be filled out by requesting unit (fig 3–37). Malfunction description (for DSU/GSU use). Leave blank. Describe deficiencies or symptoms. Print Request ECOD.

25. REMARKS. Print Total Cost of ECOD. Figures from DA Form 2404 for total man-hour costs and total parts costs are added and entered in this block.

26. TECHNICAL REFERENCES. Enter the reference TM or technical publication.

SECTION IV—TASK REQUIREMENTS DATA. This section of the work order can be used in various ways by the support maintenance activity. Enter one task repair action for the work order; one task for each center/shop section that is to work on the equipment; or a task management to allow the capturing of man-hours expended on the equipment. The task sequence number is not to be confused with work order request status code changes.

27a. FILE INPUT ACT CD. Enter file input action code: A—Addition of new record file, C—Correction to the file records, D—Deletion of record from the file.

27b. TASK NO. Enter the task number. The use of this field is up to the support maintenance activity. However, at least one character (letter or number) must be used and task numbers must be different for each task listed. Some of the various ways this field can be used follows:

1. Single task (for example, task number 1) for all work needed to be done.
2. A task for each work center/shop section for work needed to be done at each work center/shop section. The task number can be the shop section code.
3. A task for each action specified to be done by inspectors. The task number can be the character for the shop followed by a different number for each task. For example, tasks A1, A2, and A3 for the automotive section and task S1 and S2 for the service section.

27c. ACT CODE. Enter Action Code. Table B–5 lists these codes.

27d. TASK DESCRIPTION. Enter brief description of task to be accomplished.

27e. QTY TO BE RPR. Enter number of items to be repaired or leave blank.

27f. WORK CENTER. Enter the Work Center Code of the shop that will do the task. (See unit SOP.)

27g. FAILURE CODE. Enter the appropriate failure code from table B-1.

27h. MH PROJ. Enter number of man-hours projected to accomplish the task.

27i. MH EXP. After completion, enter number of man-hours actually expended to accomplish the task.

SECTION V—PART REQUIREMENTS.

28m. TOTAL MANHOURS. Enter total of man-hours of ECOD from all pages (DA Forms 2404).

28n. TOTAL MANHOUR COSTS. Enter total man-hour cost. Get this figure by multiplying the current local labor rate times the total number of man-hours used in 28m.

28o. TOTAL PARTS COSTS. Enter total costs of parts listed on all pages (DA Forms 2404).

SECTION VI—COMPLETION DATA.

29. QTY RPR. Leave blank.

30. QTY CONDEMN. Leave blank.

31. QTY NRTS. Leave blank.

32. EVAC WON. Leave blank.

33. EVAC UNIT NAME. Leave blank.

SECTION VII—ACTION SIGNATURES.

35a. ACCEPTED BY. The person accepting the work request enters first initial and last name in this block.

35b. STATUS. Enter the work request status code. Table B–21 lists these codes.

35c. DATE. Enter ordinal date accepted (YYDDD).

35d. TIME. Enter the military time that the work was started.

36a. WORK STARTED BY. The person assigned the work enters employee number in this block.

36b. STATUS. Enter the completed work request status code. Table B–21 lists these codes.

36c. DATE. Enter the ordinal date the work was completed (YYDDD).

36d. TIME. Enter the military time that the inspection was completed.

37a. INSPECTED BY. The person clearing the work enters first initial and last name in this block.

37b. STATUS. Enter the work request status code. Table B–21 lists these codes.

37c. DATE. Enter the ordinal date the inspection was completed (YYDDD).

37d. TIME. Enter the military time that the inspection was completed.

38a. PICKED UP BY. The person picking up the equipment for the owner enters first initial and last name in this block.

38b. STATUS. The support maintenance clerk enters work request status code U (picked up). Table B–21 lists these codes.

38c. DATE. Enter ordinal date the equipment was picked up (YYDDD).

**Figure 3–38. Sample DA Form 2407 used for ECOD**

38d. TIME. Enter the military time that the equipment was picked up.

Figure 3-38. Sample DA Form 2407 used for ECOD

MAINTENANCE REQUEST For use of this form, see DA PAM 750 8 and 738-751; the proponent agency is DCS, G4				PAGE NO	NO OF PAGES	REQUIREMENT CONTROL SYMBOL CSGLD-1047(R1)	
SECTION I - CUSTOMER DATA				SECTION II - MAINTENANCE ACTIVITY DATA			
1a. UIC CUSTOMER WAF4AA	1b. CUSTOMER UNIT NAME ACo 112 <sup>th</sup> Inf	1c. PHONE NO 683-2696		3a. WORK ORDER NUMBER (WON)	3b. SHOP	3c. PHONE NO	
2a. SAMS-2 UIC/SAMS-I/TDA	2b. UTILIZATION CODE φ	2c. MCSR Y		4a. UIC SUPPORT UNIT		4b. SUPPORT UNIT NAME	
SECTION III - EQUIPMENT DATA							
5. TYPE MNT REQ CODE 2	6. ID A	7. NSN 232φφ111φ77155		15a. FAILURE DETECTED DURING/WHEN DISCOVERED CODE (Enter code) See DA Pamphlets 738-750 and 738-751			
8. MODEL M998		9. NOUN TRK Utility VHT 4x4		15b. FIRST INDICATION OF TROUBLE/HOW RECOGNIZED CODE (Enter Code) See DA Pamphlets 738-750 and 738-751		16. MILES/KILOMETERS/HOURS/ROUNDS M 13561 K	
10a. ORG WORN/DOC NO X.F.4.A.A.1.7.φ.3.2.2		10b. EIC B.B.D		17. PROJECT CODE		18. ACCOUNT PROCESSING CODE	
11. SERIAL NUMBER 064139		12. QTY φ		13. PD 1.3		19. IN WARRANTY (enter Y or N) N	
14. MALFUNCTION DESCRIPTION (for DSU, GSU/AVIM, DEPOT use) MWO 9-232φ-28φ-35-1				21. REIMBURSABLE CUSTOMER (if Intransit customer enter Y or N)		20. ADMIN NO (enter Y or N) N	
22. LEVEL OF WORK F				23. SIGNATURE			
24. DESCRIBE DEFICIENCIES OR SYMPTOMS ON THE BASIS OF COMPLETE CHECKOUT AND DIAGNOSTIC PROCEDURES IN EQUIPMENT TM (Do not prescribe repairs) Apply MWO 9-232φ-28φ-35-1							
25. REMARKS							
PREPARATION INSTRUCTIONS FOR THIS PAGE							
SECTION I				SECTION III (Cont'd)			
<p>Block 1a. Enter UIC of submitting organization. Block 1b. Enter name of submitting organization. Block 1c. Enter number to be called when maint. is completed. Block 2a. Enter UIC of supporting SAMS-2/SAMS-I/TDA if work is requested while intransit and away from your support maintenance unit. Block 2b. Enter utilization code. See DA Pamphlets 738-750 and 738-751. Block 2c. Enter "Y" if reportable under AR 700-138. If not, leave blank.</p>				<p>Block 12. Enter the quantity of items being submitted. Block 13. Enter the maintenance priority designator determined from DA PAM 710-2-1. Block 14. For DSU, GSU/AVIM, DEPOT use. Block 15a. Enter the code that most accurately describes when the fault or deficiency was detected. See DA Pamphlets 738-750 and 738-751. Block 15b. Select one. Enter the code. See DA Pamphlets 738-750 and 738-751. Block 16. Enter the accumulated usage data in blocks, when equipment is subject to usage reporting. Block 17. Enter the project code if one has been assigned. If not, leave blank. Block 18. See DA Pamphlets 738-750 and 738-751. Block 19. Enter "Y" or "N" to indicate whether equipment is still under manufacturer's warranty. Block 20. Enter the admin number assigned for property control purposes for the equipment being submitted. Block 21. For DSU/GSU/AVIM/Depot use. Block 22. Enter level of work performed "O" for UNIT LEVEL/AVUM, "F" for DSU/AVIM, "H" for GSU, "D" for DEPOT, "K" for contractor or "L" for Spc Rpr Act. Block 23. Enter the signature of the CO or the CO's designated representative when the priority designator is 01-10. For priority designators 11-15, leave blank. Block 24. Enter a brief description of the deficiencies or symptoms that you feel require attention at this level of maint. Block 25. Self-explanatory.</p>			
SECTION II							
Leave blank. To be completed by the support maintenance DSU/GSU/AVIM/DEPOT.							
SECTION III							
<p>Block 5. Enter the Type Maintenance Request Code. See DA Pamphlets 738-750 and 738-751. Block 6. Enter ID associated with block 7. See DA Pamphlets 738-750 and 738-751. Block 7. Enter the NSN or stock number of the item being submitted. Block 8. Enter model of item being submitted. Block 9. Enter noun/nomenclature of item being submitted. Block 10a. Enter Work Order Number (WON)/DOC NO assigned when item is submitted. Otherwise, leave blank. Block 10b. Enter End Item Code. See AMDF. Block 11. Enter serial number of item being submitted.</p>							
34a. SUBMITTED BY D. Dale	35a. ACCEPTED BY	35c. DATE		Block 34a. Enter first initial and last name of submitter. Block 34b. Enter ordinal date submitted (YYDDD). Block 35a. Enter first initial and last name of person accepting maint. request. Block 35b. Enter the initial status. See DA Pamphlets 738-750 and 738-751. Block 35c. Enter ordinal date accepted (YYDDD). Block 35d. Enter military time.			
34b. DATE 97φ28	35b. STATUS	35d. TIME					

DA FORM 2407, JUL 94

PREVIOUS EDITIONS OF DA FORM 2407 AND DA FORM 5604 ARE OBSOLETE

RECEIPT COPY 1

Notes:

<sup>1</sup> Blocks 1, 5, 6, 7, 10a, 10b, 11, 12, 13, 15, 16, 20, and 24 are mandatory if equipment is inoperative. Inoperative equipment is equipment that is NMC, in accordance with AR 700-138, a subsystem of a reportable weapon system, or command maintenance significant.

Figure 3-39. Sample DA Form 2407 used to request an MWO

Legend for Figure 3–39;

completion instructions to request an MWO follow.

SECTION I—CUSTOMER DATA.

- 1a. UIC CUSTOMER. Enter the UIC of the customer that owns the equipment.
- 1b. CUSTOMER UNIT NAME. Enter the name of the unit identified by the UIC in block 1a.
- 1c. PHONE NO. Enter the phone number of the unit identified by the UIC in block 1a.
- 2a. SAMS–2 UIC/SAMS-I/TDA. If in transit, enter UIC for SAMS–2 or SAMS-I/TDA unit.
- 2b. UTILIZATION CODE. Enter Utilization Code. See appendix B.
- 2c. MCSR. Print the word yes or the letter Y if the item is reported under AR 700–138. This also applies to components and subsystems of an item/system that is reportable. If not, leave this block blank.

SECTION II—MAINTENANCE ACTIVITY DATA. To be completed by support maintenance DSU/GSU/AVIM/DEPOT.

SECTION III—EQUIPMENT DATA.

5. TYPE MNT REQ CODE. Enter the Type Maintenance Request Code. Table B–20 lists the codes.
  6. ID. Enter the identification (ID) code as shown below that identifies the type of number to be entered in block 7: A—National NATO Stock Number, C—Manufacturers Code and Reference Number (Part Number), D—Management Control Number (MCN), P—Other Numbers.
  7. NSN. Enter the National Stock Number or appropriate number identified in block 6. When applying an MWO to a component, enter the end items NSN in this block.
  8. MODEL. Enter model number.
  9. NOUN. Enter noun nomenclature of item.
  - 10a. ORG WON/DOC No. Enter organization work order number or organization document number. For assignment of the ORG WON, see paragraph 3–4.
  - 10b. EIC. Enter the end item code (EIC). See AMDF.
  11. SERIAL NUMBER.
    - a. Enter the serial number of the item in block 9.
    - b. For nontactical-wheeled vehicles, use the registration number.
    - c. For ammunition, use the lot number.
    - d. For watercraft, use DA Hull number.
    - e. Leave blank if the form is used for more than one item.
    - f. Leave blank if equipment has more than one serial number.
    - g. Mandatory entry if equipment is inoperative.
  12. QTY. Enter the number of items. (Must be only one item listed if equipment is reportable under AR 700–138 and is NMC.)
  13. PD. Enter the Priority Designator (see AR 750–1, para 3–7).
  14. MALFUNCTION DESCRIPTION (*for DSU, GSU/AVIM, DEPOT use*). Enter MWO number, if known. Failure detected during/when discovered code. Leave blank. First indication of trouble/how recognized code. Leave blank.
  16. MILES/KILOMETERS/HOURS/ROUNDS. Enter the miles or kilometers from the odometer on the equipment beside the “M” or “K.” Round to the nearest mile or kilometer. If the equipment has no odometer, leave blank. Enter the hour reading (to the nearest hour) beside the “H” from the hour meter mounted on the equipment. If the equipment has no meter, leave blank. Enter the total EFC rounds fired beside the “R”. See the items DA Form 2408–4. If rounds do not apply to the equipment, leave blank.
  17. PROJECT CODE (*if assigned*). Enter the project code if one has been assigned. If not, leave blank.
  18. ACCOUNT PROCESSING CODE. Enter the Account Processing Code (APC) if required by the unit. The APC is a code prescribed locally for costing and budget identification of customers and organizations. If not required, leave blank.
  19. IN WARRANTY? Enter Y or N to indicate whether equipment is still under manufacturers warranty. If Y, submit one work request for each serial numbered item.
  20. ADMIN NUMBER. Enter the bumper number/materiel control number, or administrative number assigned to the item of equipment.
  21. REIMBURSABLE CUSTOMER (*if Intransit customer enter Y or N*). For DSU/GSU/AVIM/Depot use.
  22. LEVEL OF WORK. Enter code for level of work from table B–24.
  23. SIGNATURE. The commander or the commander’s designated representative signs for all priority 01 through 10 requests. The signature approves the use of the PD.
  24. DESCRIBE DEFICIENCIES OR SYMPTOMS ON THE BASIS OF COMPLETE CHECKOUT AND DIAGNOSTIC PROCEDURES IN EQUIPMENT TM (*Do not prescribe repairs*).
    1. Enter the MWO numbers. If more than one MWO is listed, make sure all the MWOs apply to each component or end item covered by the form.
    2. When applying MWOs to more than one nonreportable item, give the serial number of each item.
  25. REMARKS. Use as needed locally or as prescribed by the local SOP.
- SECTION VII—ACTION SIGNATURES
- 34a. Submitted by. The person sending in DA Form 2407 enters first initial and last name in this block.
  - 34b. Date. The person signing the forms enters the original ordinal date the form was given to support maintenance.
  - 35a–35d. To be completed by the supporting DSU.

**Figure 3–39. Sample DA Form 2407 used to request an MWO**



MAINTENANCE REQUEST For use of this form, see DA PAM 750-8 and 738-751; the proponent agency is DCS, G4				PAGE NO	NO OF PAGES	REQUIREMENT CONTROL SYMBOL CSGLD-1047(R#)					
SECTION I - CUSTOMER DATA				SECTION II - MAINTENANCE ACTIVITY DATA							
1a. UIC CUSTOMER WXE4AA	1b. CUSTOMER UNIT NAME ACO 112 <sup>th</sup> Inf	1c. PHONE NO 683-2696	3a. WORK ORDER NUMBER (WOM) X244AA712350	3b. SHOP A	3c. PHONE NO 683-3631						
2a. SAMS-2 UIC/SAMS-1/DA	2b. UTILIZATION CODE φ	2c. MCSR Y	4a. UIC SUPPORT UNIT WXE4AA	4b. SUPPORT UNIT NAME 2117 <sup>th</sup> Maint Co							
SECTION III - EQUIPMENT DATA											
5. TYPE MNT REQ CODE 2	6. ID A	7. NSN 2320011077155		15a. FAILURE DETECTED DURING/WHEN DISCOVERED CODE (Enter code) See DA Pamphlets 738-750 and 738-751			16. MILES/KILOMETERS/HOURS/ROUNDS RECOGNIZED CODE (Enter Code) See DA Pamphlets 738-750 and 738-751				
8. MODEL M998			9. NOUN TRK, utility 14T 4x4			M	13561	K			
10a. ORG W/M/DOC NO XFE4AA11700322		10b. EIC B.B.D		17. PROJECT CODE (if assigned)		18. ACCOUNT PROCESSING CODE		19. IN WARRANTY? 20. ADMIN NO (enter Y or N) N MS30			
11. SERIAL NUMBER 64139		12. QTY φ		13. PD 1.3		21. REIMBURSABLE CUSTOMER (if intransit customer enter Y or N)		22. LEVEL OF WORK F			
14. MALFUNCTION DESCRIPTION (for DSU, GSU/AVIM, DEPOT use) MWO 9-2320-280-35-1				23. SIGNATURE							
24. DESCRIBE DEFICIENCIES OR SYMPTOMS ON THE BASIS OF COMPLETE CHECKOUT AND DIAGNOSTIC PROCEDURES IN EQUIPMENT TM (Do not prescribe repairs) Apply MWO 9-2320-280-35-1											
25. REMARKS											
26. TECHNICAL REFERENCES TM 9-2320-280-34											
SECTION IV - TASK REQUIREMENTS DATA											
27a. FILE INPUT ACT CD	27b. TASK NO	27c. ACT CODE	27d. TASK DESCRIPTION	27e. QTY TO BE RPR	27f. WORK CENTER	27g. FAILURE CODE	27h. MH PROJ	27i. MH EXP			
A	11	F	Initial Inspection	φ	Insip		5	1.5			
A	11	H	Apply MWO 9-2320-280-35-1	φ	Auto		8.0	7.15			
A	12	G	Final Inspection	φ	Insip		5	1.5			
SECTION V - PART REQUIREMENTS											
28a. FILE INPUT ACT CD	28b. TASK NO	28c. ID NO	28d. NSN OR PART NUMBER	28e. SFX CD	28f. QTY RQD	28g. QTY ISSUED	28h. NMCS CD	28i. FAILURE CODE	28j. STORAGE LOCATION	28k. INITIALS	28l. COST \$
A	11	A	2530013121924		φ	φ	N		MWOAK	RS	
28m. TOTAL MANHOURS 8.5			28n. TOTAL MANHOURS COSTS \$			28o. TOTAL PARTS COSTS \$					
SECTION VI - COMPLETION DATA											
29. QTY RPR			30. QTY CONDEMN			31. QTY NRTS			32. EVAC WON		33. EVAC UNIT NAME
SECTION VII - ACTION SIGNATURES											
34a. SUBMITTED BY D Dale C. Carlson		35a. ACCEPTED BY C. Carlson		35c. DATE 97028		36a. WORK STARTED BY R. Spurlord		37a. INSPECTED BY M. Arnold		38a. PICKED UP BY J. Briscoe	
34b. DATE 97028		35b. STATUS A		35d. TIME 1300		36b. STATUS B		36d. DATE 97031		36f. TIME 1030	
37b. STATUS S		37c. DATE 97031		37d. TIME 1600		38b. STATUS U		38c. DATE 97030		38d. TIME 0930	

DA FORM 2407, JUL 94

ORGANIZATION COPY 4

Legend for Figure 3-40;

Completion instructions to document an MWO done at support maintenance follow.

PAGE NO. Enter the page number when all needed entries are in Sections IV-VII. Enter page numbers as required.

NO OF PAGES. Enter the total number of pages used when entries are in Sections IV-VII. Enter page numbers as required.

SECTION I—CUSTOMER DATA. Previously completed.

SECTION II—MAINTENANCE ACTIVITY DATA.

Figure 3-40. Sample DA Form 2407 used to document an MWO

3a. WORK ORDER NUMBER (WON). Enter WON (see paragraph 3–4 for assignment of WONs).

3b. SHOP. Enter shop section code. These codes are assigned to uniquely identify a particular maintenance shop section. Each maintenance battalion operating SAMS assigns codes A through Z locally. Examples: A—Automotive shop, B—Battery shop, C—Common shop, and so on.

3c. PHONE NO. Enter the phone number of the maintenance activity.

4a. UIC SUPPORT UNIT. Enter the UIC of the Maintenance Activity.

4b. SUPPORT UNIT NAME. Enter the unit name of the Maintenance Activity.

SECTION III—EQUIPMENT DATA. Blocks 5–24 previously completed.

21. REIMBURSABLE CUSTOMER (if Intransit customer enter Y or N). Enter Y if the customer must pay for maintenance cost.

25. REMARKS. Use as needed locally or as prescribed by SOP. Technical References. Enter the referenced TM or technical publication.

SECTION IV—TASK REQUIREMENTS DATA. This section of the work order can be used in various ways by the support maintenance activity. Enter one task repair action for the work order; one task for each center/shop section that is to work on the equipment; or a task management to allow the capturing of man-hours expended on equipment. The task sequence number is not to be confused with work order request status code changes.

27a. FILE INPUT ACT CD. Enter the file input action code: A—Addition of a new record file, C—Correction to the file records, D—Deletion of record from the file.

27b. TASK NO. Enter the task number. The use of this field is up to the support maintenance activity. However, at least one character (letter or number) must be used and task numbers must be different for each task listed. Some of the various ways this field can be used follows:

1. Single task (for example, task number 1) for all work needed to be done.
2. A task number for each work center/shop section for work needed to be done at each work center/shop section. The task number can be the shop section code.
3. A task for each action specified to be done by inspectors. The task number can then be the character for the shop followed by a different number for each task. For example, tasks A1, A2, and A3 for the automotive section and tasks S1 and S2 for the service section.

27c. ACT CODE. Enter Action Code. Table B–5 lists the action codes.

27d. TASK DESCRIPTION. Enter brief description of task to be accomplished.

27e. QTY TO BE RPR. Enter number of items to be repaired or leave blank.

27f. WORK CENTER. Enter the Work Center Code for the shop that will do the task. (See unit SOP.)

27g. FAILURE CODE. Leave blank.

27h. MH PROJ. Enter number of man-hours projected to accomplish the task.

27i. MH EXP. After completion, enter number of man-hours actually expended to accomplish the task.

SECTION V—PART REQUIREMENTS.

28a. FILE INPUT ACT CD. Enter the File Input Action Code: A—Addition of a new record file, C—Correction to the file records.

28b. TASK NO. Enter Task Number from block 27b, which justified the part requirement.

28c. ID NO. Enter Identifying Number. These codes identify the type of information in the NSN field: A—National Stock Number, C—Manufacturers Code and Reference Number, D—Management Control Number, P—Other Numbers.

26d. NSN Or Part Number. Enter National Stock Number, Manufacturers Part Number, or other number, as identified in block 28c, for the required part.

28e. SFX CD. If applicable, enter Suffix Identification Code. This code allows the operator to use the same record key (that is, work order number, task number, identification code, and NSN), when adding the same NSN to a file. It enables the operator to bypass edits that normally it would reject as being duplicate. Each new entry should be in sequential order. (Blank and A–Z are the allowed entries.)

28f. QTY RQD. Enter quantity of parts required.

28g. QTY ISSUED. When part(s) is issued to mechanic, enter quantity of part(s) issued.

28h. NMCS CD. If failure to get a part caused the item to become NMCS, enter Y (YES). If item will not become NMCS, enter N (NO).

28i. FAILURE CODE. Leave blank.

28j. STORAGE LOCATION. If SSL item, enter Storage Location Code. If not, leave blank.

28k. INITIALS. Enter initials of SSL clerk releasing parts to mechanic.

28l. COST. Leave blank or use as needed locally.

28m. TOTAL MANHOURS. Enter total man-hours of block 27 from all pages (DA Forms 2407/2407–1).

28n. TOTAL MANHOURS COST. Leave blank or use as needed locally.

28o. TOTAL PARTS COSTS. Leave blank or use as needed locally.

SECTION VII—ACTION SIGNATURES.

35a. ACCEPTED BY. The person accepting the work request enters first initial and last name in this block.

35b. STATUS. Enter the work request status code. Table B–21 lists these codes.

35c. DATE. Enter ordinal date accepted (YYDDD).

35d. TIME. Enter the military time that the work was started.

36a. WORK STARTED BY. The person assigned the work enters employee number in this block.

36b. STATUS. Enter the completed work request status code. Table B–21 lists these codes.

36c. DATE. Enter the ordinal date the work was completed (YYDDD).

**Figure 3–40. Sample DA Form 2407 used to document an MWO**

- 36d. TIME. Enter the military time that the inspection was completed.
- 37a. INSPECTED BY. The person clearing the work enters first initial and last name in this block.
- 37b. STATUS. Enter the work request status code. Table B-21 lists these codes.
- 37c. DATE. Enter the ordinal date the inspection was completed.
- 37d. TIME. Enter the military time that the inspection was completed.
- 38a. PICKED UP BY. The person picking up the equipment for the owner enters first initial and last name in this block.
- 38b. STATUS. The support maintenance clerk enters work request status code U (picked up). Table B-21 lists these codes.
- 38c. DATE. Enter the ordinal date the equipment was picked up (YYDDD).
- 38d. TIME. Enter the military time that the equipment was picked up.

Figure 3-40. Sample DA Form 2407 used to document an MWO

MAINTENANCE REQUEST For use of this form, see DA PAM 750-8 and 738-751; the proponent agency is DCS, G4										PAGE NO	NO OF PAGES	REQUIREMENT CONTROL SYMBOL CSGLD-1047(R1)
SECTION I - CUSTOMER DATA					SECTION II - MAINTENANCE ACTIVITY DATA							
1a. UIC CUSTOMER WGPPAA	1b. CUSTOMER UNIT NAME 27th Trans Bn	1c. PHONE NO 837-1009	3a. WORK ORDER NUMBER (WON) E7LAA712345	3b. SHOP C	3c. PHONE NO 955-9727							
2a. SAMS-2 UIC/SAMS-1/IDA φ	2b. UTILIZATION CODE φ	2c. MCSR Y	4a. UIC SUPPORT UNIT WIE7LAA	4b. SUPPORT UNIT NAME 596th OD Co.								
SECTION III - EQUIPMENT DATA												
5. TYPE MNT REQ CODE 1	6. ID A	7. NSN 58250129849161	15a. FAILURE DETECTED DURING/WHEN DISCOVERED CODE (Enter code) See DA Pamphlets 738-750 and 738-751									
8. MODEL AN/PRD-12			15b. FIRST INDICATION OF TROUBLE/HOW RECOGNIZED CODE (Enter Code) See DA Pamphlets 738-750 and 738-751			M	K					
9. NOUN Direction Finding System			16. MILES/KILOMETERS/HOURS/ROUNDS H 5597 R									
10a. ORG WON/DOC NO C.P.P.A.A.700001	10b. EIC L.61F											
11. SERIAL NUMBER 274	12. QTY 1	13. PD 03	17. PROJECT CODE (if assigned)	18. ACCOUNT PROCESSING CODE	19. IN WARRANTY (enter Y or N)	20. ADMIN NO Y AB9						
14. MALFUNCTION DESCRIPTION (for DSU, GSUIAVIM, DEPO1 use) Disciplinary, Final			21. REIMBURSABLE CUSTOMER (if intransit customer enter Y or N)		22. LEVEL OF WORK F		23. SIGNATURE Joe Spurlock					
24. DESCRIBE DEFICIENCIES OR SYMPTOMS ON THE BASIS OF COMPLETE CHECKOUT AND DIAGNOSTIC PROCEDURES IN EQUIPMENT TM (Do not prescribe repairs) Liquid Crystal Display on the Control Display Unit remains blank after power up.												
25. REMARKS Start Date: Jan 97 SFC Pellegrino DSN 992-5721 WE7LAA Contract #DAG-95-A472												
26. TECHNICAL REFERENCES												
SECTION IV - TASK REQUIREMENTS DATA												
27a. FILE INPUT ACT CD	27b. TASK NO	27c. ACT CODE	27d. TASK DESCRIPTION	27e. QTY TO BE RPR	27f. WORK CENTER	27g. FAILURE CODE	27h. MH PROJ	27i. MH EXP				
A	A01	F	Initial Inspection	1	FAW		1.5	1.5				
A	A01	A	Replace Display Unit	1	FAW	21515	1.0	1.0				
A	A02	G	Final Inspection	1	FAW		1.5	1.5				
SECTION V - PART REQUIREMENTS												
28a. FILE INPUT ACT CD	28b. TASK NO	28c. ID NO	28d. NSN OR PART NUMBER	28e. SFX CD	28f. QTY RQD	28g. QTY ISSUED	28h. NMCS CD	28i. FAILURE CODE	28j. STORAGE LOCATION	28k. INITIALS	28l. COST \$	
A	A01	A	20250130429816	A	1	1	N	255	B2503	cdc	21351	
28m. TOTAL MANHOURS			28n. TOTAL MANHOURS COSTS \$			28o. TOTAL PARTS COSTS \$						
2.0			13,914.0			2,481.11						
SECTION VI - COMPLETION DATA												
29. QTY RPR		30. QTY CONDEMN		31. QTY NRTS		32. EVAC WON		33. EVAC UNIT NAME				
SECTION VII - ACTION SIGNATURES												
34a. SUBMITTED BY B. Inouye		35a. ACCEPTED BY C. Daniels		35c. DATE 97003		36a. WORK STARTED BY M. Newton		37a. INSPECTED BY G. Carter		38a. PICKED UP BY J. Martin		
34b. DATE 97003		35b. STATUS A		35d. TIME 0730		36b. STATUS B		37b. DATE 97003		38b. TIME 0815		
								37c. DATE 97003		38c. TIME 1530		
										38d. TIME 0900		

Notes:  
 1 Blocks 1, 5, 6, 7, 10a, 10b, 11, 12, 13, 15, 16, 20, and 24 are mandatory if equipment is inoperative. Inoperative equipment is equipment that is NMC, in accordance with AR 700-138, a subsystem of a reportable weapon system, or command maintenance significant.

Figure 3-41. Sample DA Form 2407 used for warranty claim actions

Legend for Figure 3-41;

completion instructions for WCAs follow.

SECTION I—CUSTOMER DATA.

- 1a. UIC CUSTOMER. Enter the UIC of the customer that owns the equipment.
- 1b. CUSTOMER UNIT NAME. Enter the name of the unit identified by the UIC in block 1a.
- 1c. PHONE NO. Enter the phone number of the unit identified by the UIC in block 1a.
- 2a. SAMS-2 UIC/SAMS-I/TDA. IF in transit, enter the UIC of the SAMS-2 or SAMS-I/TDA unit.
- 2b. UTILIZATION CODE. Enter Utilization Code. See appendix B.
- 2c. MCSR. Print the word Yes or the letter Y if the item is reported under AR 700-138. This also applies to components and subsystems of an item/system that is reportable. If not, leave this block blank.

SECTION II—MAINTENANCE ACTIVITY DATA. To be completed by support maintenance DSU/GSU/AVIM/DEPOT.

SECTION III—EQUIPMENT DATA.

5. TYPE MNT REQ CODE. Enter the Type Maintenance Request Code. Table B-20 lists the codes.
6. ID. Enter the identification (ID) Code as shown below that identifies the type of number to be entered in block 7: A—National/NATO Stock Number, C—Manufacturers Code and Reference Number (Part Number), D—Management Control Number (MCN), P—Other Numbers.
7. NSN. Enter the National Stock Number of appropriate number identified in block 6.
8. MODEL. Enter model number.
9. NOUN. Enter noun nomenclature of item.
- 10a. ORG WON/DOC NO. Enter organization work order number or organization document number. For assignment of the ORG WON, see paragraph 3-4.
- 10b. EIC. Enter the end item code (EIC). See AMDF.
11. Serial number.
  - a. Enter the serial number of the item in block 9.
  - b. For nontactical wheeled vehicles, use the registration number.
  - c. For ammunition, use the lot number.
  - d. For watercraft, use DA Hull number.
  - e. Leave blank if the form is used for more than one item.
  - f. Leave blank if equipment has more than one serial number.
  - g. Mandatory entry if equipment is inoperative.
12. QTY. Enter the number of items. (Must be only one item listed if equipment is reportable under AR 700-138 and is NMC.)
13. PD. Enter the Priority Designator. (See AR 750-1, para 3-7.)
14. MALFUNCTION DESCRIPTION (*for DS, GSU/AVIM, DEPOT use*). Enter the appropriate description.
- 15a. FAILURE DETECTED DURING/WHEN DISCOVERED CODE (*Enter code*). Leave blank.
- 15b. FIRST INDICATION OF TROUBLE/HOW RECOGNIZED CODE (*Enter code*). Leave blank.
16. MILES/KILOMETERS/HOURS/ROUNDS. Enter the miles or kilometers from the odometer on the equipment beside the M or K. Round to the nearest mile or kilometer. If the equipment has no odometer, leave blank. Enter the hour reading (to the nearest hour) beside the H from the hourmeter mounted on the equipment. If the equipment has no meter, leave blank. Enter the total EFC rounds fired beside the R. See the items DA Form 2408-4. If rounds do not apply to the equipment, leave blank.
17. PROJECT CODE. Enter the project code if one has been assigned. If not, leave blank.
18. ACCOUNT PROCESSING CODE. Enter the Account Processing Code (APC) if required by the unit. The APC is a code prescribed locally for costing and budget identification of customers and organizations. If not required, leave blank.
19. IN WARRANTY? Enter Y to indicate that equipment is still under manufacturers warranty. Submit one work request for each serial numbered item.
20. ADMIN NO. Enter the bumper number, materiel control number, or administrative number assigned to the item of equipment.
21. REIMBURSABLE CUSTOMER (*if Intransit customer, enter Y or N*). For DSU/GSU/AVIM/Depot use.
22. LEVEL OF WORK. Enter code for level of work from table B-24.
23. SIGNATURE. The commander or the commander's designated representative signs for all priority 01 through 10 requests. The signature approves the use of the PD.
24. DESCRIBE DEFICIENCIES OR SYMPTOMS ON THE BASIS OF COMPLETE CHECKOUT AND DIAGNOSTIC PROCEDURES IN EQUIPMENT TM (*Do not prescribe repairs*).
  1. Enter brief, but specific description of failure as a result of complete checkout and diagnosis.
  2. Include such factors as weather conditions and type of operations. Provide a reason of why it failed. If more room is needed, use DA Form 2407-1.
  3. When the warranty technical bulletin provides instructions to ship the failed warranted item to another location, the WARCO enters the shipped to DODAAC.
25. REMARKS. Enter the warranty start date of the component/end item. That date is found on the warranty decal on the item or on DA Form 2408-9 of the item. The WARCO enters his or her name, complete phone number (DSN or commercial), UIC, and contract number.
26. TECHNICAL REFERENCES. Enter the referenced TM or technical publication.

**Figure 3-41. Sample DA Form 2407 used for warranty claim actions**

SECTION IV—TASK REQUIREMENTS DATA. This section of the work order can be used in various ways by the support maintenance activity. Enter one task repair action for the work order; one task for each center/shop section that is to work on the equipment, or a task management to allow the capturing of man-hours expended on equipment. The task sequence number is not to be confused with work request status code changes.

27a. FILE INPUT ACT CD. Enter File Input Action Code: A—Addition of a new record file, C—Correction to the file records, D—Deletion of record from the file.

27b. TASK NO. Enter the Task Number. The use of this field is up to the support maintenance activity. However, at least one character (letter or number) must be used and task numbers must be different for each task listed. Some of the various ways this field can be used follow:

1. A single task (for example, task number 1) for all work needed to be done.
2. A task number for each work center/shop section or work needed to be done at each work center/shop section. The task number can be the shop section code.
3. A task for each action specified to be done by inspectors. The task number can then be the character for the shop followed by a different number for each task. For example, tasks A1, A2, and A3 for the Automotive Section and tasks S1 and S2 for the Service Section.

27c. ACT CODE. Enter action code. Table B-5 lists the action codes.

27d. TASK DESCRIPTION. Enter brief description of task to be accomplished.

27e. QTY To Be RPR. Enter number of items to be repaired or leave blank.

27f. WORK CENTER. Enter the Work Center Code of the shop that will do the task (see Unit SOP).

27g. FAILURE CODE. Enter Failure Code from tables B-1 and B-2.

27h. MH PROJ. Enter number of man-hours projected to accomplish the task.

27i. MH EXP. After completion, enter number of man-hours actually expended to accomplish the task.

SECTION V—PART REQUIREMENTS.

28a. FILE INPUT ACT CD. Enter the File Input Action Code: A—Addition of a new record file, C—Correction to the file records.

28b. TASK NO. Enter the task number from block 27b, which justified the part requirement.

28c. ID NO. Enter Identifying Number. These codes identify the type of information in the NSN field: A—National Stock Number, C—Manufacturers Code and Reference Number, D—Management Control Number, P—Other numbers.

28d. NSN Or Part Number. Enter National Stock Number, Manufacturers Part Number, or other number, as identified in block 28c, for the required part.

28e. SFX CD. IF applicable, enter Suffix Identification Code. This code allows the operator to use the same record key (that is, work order number, task number, identification code, and NSN) when adding the same NSN to a file. It enables the operator to bypass edits that normally would reject as being duplicate. Each new entry should be in sequential order. (Blank and A-Z are the allowed entries.)

28f. QTY RQD. Enter quantity of part(s) required.

28g. QTY ISSUED. When part(s) is issued to mechanic, enter quantity of part(s) issued.

28h. NMCS CD. If failure to get a part caused the item to become NMCS, enter Y (YES). If item will not become NMCS, enter N (NO).

28i. FAILURE CODE. Enter Failure Code from tables B-1 and B-2.

28j. STORAGE LOCATION. If ASL item, enter Storage Location Code.

28k. INITIALS. Enter initials of ASL clerk releasing part to mechanic.

28l. COST. Leave blank or use as needed locally.

28m. TOTAL MANHOURS. Enter total man-hours of block 27 from all pages (DA Forms 2407/2407-1).

28n. TOTAL MANHOURS COSTS. Leave blank or use as needed locally.

28o. TOTAL PARTS COST. Leave blank or use as needed locally.

SECTION VII—ACTION SIGNATURES.

34a. SUBMITTED BY. The person sending in DA Form 2407 enters first initial and last name in this block.

34b. DATE. The person signing the forms enters the ordinal date the form was given to support maintenance (YYDDD).

35a. ACCEPTED BY. The person accepting the work request enters first initial and last name in this block.

35b. STATUS. Enter the work request status codes. Table B-21 lists these codes.

35c. DATE. Enter ordinal date accepted (YYDDD).

35d. TIME. Enter the military time that the work was started.

36a. WORK STARTED BY. The person assigned the work enters the first initial and last name in this block.

36b. STATUS. Enter the completed work request status code. Table B-21 lists these codes.

36c. DATE. Enter the ordinal date the work was completed (YYDDD).

36d. TIME. Enter the military time that the inspection was completed.

37a. INSPECTED BY. The person clearing the work enters employee number in this block.

37b. STATUS. Enter the work request status code. Table B-21 lists these codes.

37c. DATE. Enter the ordinal date the inspection was completed (YYDDD).

37d. TIME. Enter the military time that the inspection was completed.

38a. PICKED UP BY. The person picking up the equipment for the owner enters first initial and last name in this block.

38b. STATUS. The support maintenance clerk enters work request status code U (picked up). Table B-21 lists these codes.

38c. DATE. Enter the ordinal date the equipment was picked up (YYDDD).

**Figure 3-41. Sample DA Form 2407 used for warranty claim actions**

38d. TIME. Enter the military time that the equipment was picked up.

Figure 3-41. Sample DA Form 2407 used for warranty claim actions

MAINTENANCE REQUEST										PAGE NO	NO OF PAGES	REQUIREMENT CONTROL SYMBOL											
For use of this form, see DA PAM 750-8 and 738-751; the proponent agency is DCS, G4										1	1	CSGLD-1047(R)											
SECTION I - CUSTOMER DATA					SECTION II - MAINTENANCE ACTIVITY DATA																		
1a. UIC CUSTOMER	1b. CUSTOMER UNIT NAME	1c. PHONE NO	3a. WORK ORDER NUMBER (WON)		3b. SHOP	3c. PHONE NO																	
WAM7B0	Co B 169 AR Bn	232-1285	H88B2A700129		A	232-9375																	
2a. SAMS-2 UIC/SAMS-ITDA	2b. UTILIZATION CODE	2c. MCSR	4a. UIC SUPPORT UNIT		4b. SUPPORT UNIT NAME																		
		Y	W.H. 8.1.B.2		203 CS Bn																		
SECTION III - EQUIPMENT DATA																							
5. TYPE MNT REQ CODE	6. ID	7. NSN	15a. FAILURE DETECTED DURING/WHEN DISCOVERED CODE (Enter code)			15b. FIRST INDICATION OF TROUBLE/HOW RECOGNIZED CODE (Enter Code)			16. MILES/KILOMETERS/HOURS/ROUNDS														
I	A	2350010871095	A			M 10.500																	
8. MODEL	9. NOUN	10a. ORG WONDQCHD	10b. EIC	11. SERIAL NUMBER		12. QTY	13. PD	17. PROJECT CODE		18. ACCOUNT PROCESSING CODE	19. IN WARRANTY	20. ADMIN NO											
MVAI	Tank Combat FT	AM7B007000	A.A.B	67188		1	02	099			Y	Ball											
14. MAI FUNCTION DESCRIPTION (for DSU, GSU/AVIM, DEPOT use)										21. REIMBURSABLE CUSTOMER (if Intransit customer enter Y or N)		22. LEVEL OF WORK		23. SIGNATURE									
Eng Case Cracked, Cracked										F		Joe Simo											
24. DESCRIBE DEFICIENCIES OR SYMPTOMS ON THE BASIS OF COMPLETE CHECKOUT AND DIAGNOSTIC PROCEDURES IN EQUIPMENT TM (Do not prescribe repairs)																							
Engine Case Cracked, Task #A1 ID: A 2835-01-216-8639																							
25. REMARKS																							
Old SN - 1052 New SN - 2489																							
26. TECHNICAL REFERENCES																							
SECTION IV - TASK REQUIREMENTS DATA																							
27a. FILE INPUT ACT CD	27b. TASK NO	27c. ACT CODE	27d. TASK DESCRIPTION				27e. QTY TO BE RPR	27f. WORK CENTER	27g. FAILURE CODE	27h. MH PROJ	27i. MH EXP												
A	I1	F	Initial Inspection				1	01 Insp		5	5												
A	A1	A	Replace Engine				1	01 Auto	070	120	120												
A	I2	G	Final Inspection				1	01 Insp		5	5												
SECTION V - PART REQUIREMENTS																							
28a. FILE INPUT ACT CD	28b. TASK NO	28c. ID NO	28d. NSN OR PART NUMBER				28e. SFX CD	28f. QTY RQD	28g. QTY ISSUED	28h. NMCS CD	28i. FAILURE CODE	28j. STORAGE LOCATION	28k. INITIALS	28l. COST \$									
A	A1	A	2835012168639					1	1	Y	070	5F	CC	49430000									
28m. TOTAL MANHOURS			28n. TOTAL MANHOURS COSTS \$				28o. TOTAL PARTS COSTS \$																
1.3			36.9159				49430000																
SECTION VI - COMPLETION DATA																							
29. QTY RPR			30. QTY CONDEMN			31. QTY NRTS			32. EVAC WON		33. EVAC UNIT NAME												
SECTION VII - ACTION SIGNATURES																							
34a. SUBMITTED BY		35a. ACCEPTED BY		35c. DATE		36a. WORK STARTED BY		37a. INSPECTED BY		38a. PICKED UP BY													
J. Whitehead		M. Carlson		97015		D. Jackson		G. Briskam		J. Whitehead													
34b. DATE		35b. STATUS		35d. TIME		36b. STATUS		36c. DATE		36d. TIME		37b. STATUS		37c. DATE		37d. TIME		38b. STATUS		38c. DATE		38d. TIME	
97015		A		0930		B		97015		1000		R		97016		1330		U		97017		0830	

DA FORM 2407, JUL 94

CONTROL COPY 3

Legend for Figure 3-42;  
 completion instructions follow for showing work done at support maintenance for a serial number tracked item.  
 PAGE NO. Enter the page number when all needed entries are in Sections IV-VII. Enter page numbers as required.  
 NO OF PAGES. Enter the total number of pages used when entries are in Sections IV-VII. Enter page numbers as required.  
 SECTION I-CUSTOMER DATA. To be completed by unit requesting maintenance.  
 SECTION II-MAINTENANCE ACTIVITY DATA.  
 3a. WORK ORDER NUMBER (WON). Enter WON (see paragraph 3-4c for assignment of WONS).  
 3b. SHOP. Enter shop section code. These codes are assigned to uniquely identify a particular maintenance shop section. Each maintenance battalion operating SAMS assigns codes A-Z locally. Examples include A—automotive shop, B—battery shop, and C—communications shop.

Figure 3-42. Sample DA Form 2407 used for serial number tracking

3c. PHONE NO. Enter the phone number of the maintenance activity.

4a. UIC SUPPORT UNIT. Enter the UIC of the maintenance activity.

4b. SUPPORT UNIT NAME. Enter the unit name of the maintenance activity.

SECTION III—EQUIPMENT DATA.

14. MALFUNCTION DESCRIPTION (*for DSU, GSU/AVIM use*). Enter a short description of the problem (16-position entry).

21. REIMBURSABLE CUSTOMER (*if Intransit customer enter Y or N*). Enter Y if the customer must pay for maintenance cost.

24. DESCRIBE DEFICIENCIES OR SYMPTOMS ON THE BASIS OF COMPLETE CHECKOUT AND DIAGNOSTIC PROCEDURES IN EQUIPMENT TM (*Do not prescribe repairs*). The SAMS-1 work center foreman to enter appropriate SNT data use blocks 24 and 25. In block 24, enter the task no., the ID, and component NSN.

25. REMARKS. Enter the old serial number and new serial number, if applicable.

a. When the item in block 7 needs onsite or deferred maintenance, explain here. One of these entries is made for onsite or deferred work.

1. Maintenance request received on (date).
2. Onsite repair scheduled for (date).
3. Owner to return item on (date) for repair.

b. Block 35a is filled out only when the onsite repair is started or the deferred item is brought back.

c. Print "ORF candidate" when an ORF asset was issued or would have been issued if a serviceable ORF asset was available.

26. TECHNICAL REFERENCES. Enter the referenced TM or technical publication.

SECTION IV—TASK REQUIREMENTS DATA. This section of the work order can be used in various ways by the support maintenance activity. Enter one task repair action for the work order; one task for each center/shop section that is to work on the equipment; or a task management to allow the capturing of man-hours expended on equipment. The task sequence number is not to be confused with work request status code changes.

27a. FILE INPUT ACT CD. Enter file input action code: A—Addition of a new record file, C—Correction to file records, D—Deletion of a record from the file.

27b. TASK NO. Enter the task number. How to use this field is up to the support maintenance activity. However, at least one character (letter or number) must be used and task numbers must be different for each task listed. Some of the various ways this field can be used follow:

1. Single task (for example, task number 1) for all work needed to be done.
2. A task for each work center/shop section for work needed to be done at each work center/shop section. The task number can be shop section code.
3. A task for each action specified to be done by inspectors. The task number can then be the character for the shop followed by a different number for each task. For example, tasks A1, A2, and A3 for the automotive section and tasks S1, S2 and S3 for the service section.

27c. ACT CODE. Enter action code. Table B-5 lists the action codes.

27d. TASK DESCRIPTION. Enter brief description of task to be accomplished.

27e. QTY TO BE RPR. Enter number of items to be repaired.

27f. WORK CENTER. Enter the work center code of the shop that will do the task. (See unit SOP.)

27g. FAILURE CODE. Enter the failure code. Tables B-1 and B-2 list the failure codes.

27h. MH PROJ. Enter number of man-hours projected to accomplish the task.

27i. MH EXP. After completion, enter number of man-hours actually expended to accomplish the task.

SECTION V—PART REQUIREMENTS.

28a. FILE INPUT ACT CD. Enter file input action code: A—Addition of a new record file, C—Correction to the file records.

28b. TASK NO. Enter task number from block 26, which justified the part requirement.

28c. ID NO. Enter identifying number. These codes identify the type of information in the NSN field: A—National Stock Number, C—Manufacturers Code and Reference Number, D—Management Control Number, P—Other Numbers.

28d. NSN OR PART NUMBER. Enter National Stock Number, manufacturers part number, or other number as identified in block 28c, for the request part.

28e. SFX CD. If applicable, enter suffix identification code. This code allows the operator to use the same record key (that is, work order number, task number, identification code, and NSN) when adding the same NSN to a file. It enables the operator to bypass edits that normally would reject as being duplicate. Each new entry should be in sequential order. (Blank and A-Z are the allowed entries.)

28f. QTY RQD. Entry quantity of part(s) required.

28g. QTY ISSUED. When part(s) is issued to mechanic, enter quantity of part(s) issued.

28h. NMCS CD. If failure to get part caused the item to become NMCS, enter Y (yes). If item will not become NMCS, enter N (no).

28i. FAILURE CODE. Enter the failure code. Tables B-1 and B-2 list failure codes.

28j. STORAGE LOCATION. If ASL item, enter storage location code.

28k. INITIALS. Enter initials of ASL clerk releasing part to mechanic.

28l. COST \$. Enter Total Cost. (Multiply 28g by the AMDF unit price, and enter total (that is, \$50 x 3=\$150.)

28m. TOTAL MANHOURS. Enter total man-hours of block 27 from all pages (DA Forms 2407/2407-1).

28n. TOTAL MANHOURS COSTS \$. Enter total man-hour cost. Get this figure by multiplying the current local labor rate times the total number of man-hours used in 28m.

28o. TOTAL PARTS COST \$. Enter total cost of all blocks in the 28l column of all pages (DA Forms 2407/2407-1).

**Figure 3-42. Sample DA Form 2407 used for serial number tracking**

SECTION VI—COMPLETION DATA.

29. QTY RPR. Enter quantity of items repaired.

30. QTY CONDEMN. Enter quantity of items condemned.

31. QTY NRTS. Enter quantity of items not repairable at the repair activity.

32. EVAC WON. If item is evacuated, enter work order number assigned by receiving maintenance unit.

33. EVAC UNIT NAME. Enter name of unit to whom item is evacuated.

SECTION VII—ACTION SIGNATURES.

34a-b. To be completed by unit requesting maintenance.

35a. ACCEPTED BY. Block 35a is filled out only when the onsite repair is started or the deferred item is brought back. The person accepting the work order enters first initial and last name in this block.

35b. STATUS. Enter the work request status code. Table B-21 lists these codes.

35c. DATE. Enter ordinal date accepted (YYDDD).

35d. TIME. Enter the military time that the work was started.

36a. WORK STARTED BY. The person assigned the work enters employee number in this block.

36b. STATUS. Enter the completed work request status code. Table B-21 lists these codes.

36c. DATE. Enter the ordinal date the work was completed (YYDDD).

36d. TIME. Enter the military time that the inspection was completed.

37a. INSPECTED BY. The person clearing the work enters first initial and last name in this block. 37b. STATUS. Enter the work request status code. Appendix B lists these codes.

37c. DATE. Enter the ordinal date the inspection was completed.

37d. TIME. Enter the military time that the inspection was completed (YYDDD).

38a. PICKED UP BY. The person picking up the equipment for the owner enters first initial and last name in this block.

38b. STATUS. The support maintenance clerk enters work request status code U (picked up). Table B-21 lists these codes.

38c. DATE. Enter the ordinal date the equipment was picked up (YYDDD).

38d. TIME. Enter the military time that the equipment was picked up.

**Figure 3-42. Sample DA Form 2407 used for serial number tracking**

---



MAINTENANCE REQUEST (Continuation Sheet) For use of this form, see DA PAM 750-8 and 738-751; the proponent agency is DCS, G4		PAGE NO 2	NO OF PAGES 2	REQUIREMENT CONTROL SYMBOL CSGLD-1047(R1)							
SECTION II - MAINTENANCE ACTIVITY DATA											
3a. WORK ORDER NUMBER (WOM) H.C.X.A.A.A.7.0.0.1.1		3b. SHOP SECTION CODE A		3c. PHONE NO 955-9727							
SECTION III - EQUIPMENT DATA											
25. REMARKS											
SECTION IV - TASK REQUIREMENTS DATA											
27a. FILE INPUT ACT CD	27b. TASK NO	27c. ACT CODE	27d. TASK DESCRIPTION	27e. QTY TO BE RPR	27f. WORK CENTER	27g. FAILURE CODE	27h. MH PROJ	27i. MH EXP			
A	A7	A	Replaced Transf. Assy	01	Auto	190	5.2	5.2			
A	I2	G	Final Inspection	01	Insp.		1.0	1.0			
SECTION V - PART REQUIREMENTS											
28a. FILE INPUT ACT CD	28b. TASK NO	28c. ID NO	28d. NSN OR PART NUMBER	28e. SFX CD	28f. QTY RQD	28g. QTY ISSUED	28h. NMCS CD	28i. FAILURE CODE	28j. STORAGE LOCATION	28k. INITIALS	28l. COST \$
A	A7	A	2520014340822	A	01	01	N		5001A	cdc	1345.46
A	A7	A	915006982382	B	04	04	N		6134C	cdc	6.32
28m. TOTAL MANHOURS			28n. TOTAL MANHOURS COSTS \$			28o. TOTAL PARTS COSTS \$					
6.12			176.27			1251.78					

DA FORM 2407-1, JUL 94 PREVIOUS EDITIONS OF DA FORM 2407-1 AND DA FORM 5504-1 ARE OBSOLETE NMP COPY

Notes:  
 1 When used as a DA Form 2407 continuation sheet, fill in the following sections and blocks according to the instructions for the original form.  
 Legend for Figure 3-43; completion instructions follow.  
 PAGE NO. Enter the page number when all needed entries are in Sections IV-VII. Enter page numbers as required.  
 NO OF PAGES. Enter the total number of pages used when entries are in Sections IV-VII. Enter page numbers as required.

Figure 3-43. Sample DA Form 2407-1



5. If the delay is for a shop backup, enter the work or job request number in column c. Support work or job request numbers are entered only when the request has been deferred by support.
  6. Identification of a leak itself is not a fault or action that can be entered on DA Form 2408-14. But, delays required to correct a Class I or Class II leak may be entered. Each entry has a calendar date when the leak will be repaired or reevaluated. Under observation does not correct a leak and is not entered on DA Form 2408-14 as a reason for delay. Class I and II leak entries go on DA Form 2408-14 only when they require a repair or definitive action. Class III leaks are deficiencies. Repair of class III leaks cannot be deferred.
  7. Do not list faults that are on a support DA Form 2407 for repair, except support work order requests that do not render the equipment NMC (that is, communication shelters).
- DATE (From DA FORM 2404) d. Enter the calendar date the entry was transcribed to DA Form 2408-14.
- ENTRY APPROVED (Signature). The commander's designated representative signs in this block when the entry is made. Enter the first name and last name.
- DATE (To DA FORM 2407) f. Enter the calendar date the fault was actually corrected or transcribed to DA Form 2407. The individual correcting the fault enters his or her last name initial over the status symbol in column a.

**Figure 3-44. Sample of a DA Form 2408-14**

---



---

DATE: 20031203	COMMANDER'S EXCEPTION REPORT	AWCSF176				
DOCUMENT NUMBER	DESCRIPTION	ADMIN NUMBER	QTY	PRI	EXTENDED PRICE	INITIALS
W33VT7 3337 0222	TABLE, FOLD	HR02	00002	12	\$ 605.60	_____
W33VT7 3337 0224	MAPBOARD A	HR03	00004	12	\$ 575.20	_____
W33VT7 3337 0245	SCREEN, CAM	HR13	00003	12	\$ 588.00	_____
W33VT7 3337 0249	TRACK SHOE	HQ40	00016	12	\$ 1260.80	_____
W33VT7 3337 0250	LEVER, REMO	HQ85	00001	05	\$ 97.98	_____

-----  
COMMANDER'S SIGNATURE

Legend for Figure 3-45;

completion instructions follow. The Commander's Exception Report must be reviewed and initialed before the daily transactions are sent to the DSU. Any request not approved is canceled before transactions are sent to the DSU. The header information includes the date of the report.

DOCUMENT NUMBER. Self explanatory.

DESCRIPTION. Reflects the Noun of the item requested.

ADMIN NUMBER. Reflects the admin number of the equipment item.

QTY. Self explanatory.

PRI. Reflects the current priority of the item requisition.

EXTENDED PRICE. Reflect the extended price when ordering more than one item.

INITIALS. The commander or designated representative must initial each item prior to processing to the SSA. Any item not initialed is cancelled prior to submission.

COMMANDER'S SIGNATURE. Self explanatory.

**Figure 3-45. Sample ULLS-generated AWCSF176**

DATE: 20031205 SERVICE SCHEDULE DUE AWCMF450  
 DODAAC: W33VT3 A CO 3RD BN 7TH INF

-----  
 NSN: 1005010814582 MODEL: M231SMG NOUN: SUBMACH GUN 5.56MM

PUBLICATION: TM 9-1005-309-10 08/97  
 TM 9-1005-309-23&P 03 03/83

SERVICE DATA

ADMIN NUM	DATE SERVICE DUE		INTERVAL DAYS	READING DUE
A1K11L	20020518 Q		090	0
A1K11L	-----		0	0
A1K11L	-----			0
A1K11L	-----			0
A1K11L	-----			0
A1K11R	20020518 Q		090	0
A1K11R	-----		0	0
A1K11R	-----			0
A1K11R	-----			0
A1K11R	-----			0

Legend for Figure 3-46;

completion instructions follow. This report is produced by DODAAC and unit and is reflected at the top of the report. This report provides similar information to the manual DD Form 314.

NSN: Shows the National Stock Number of the item.

MODEL: Shows model number of the item.

NOUN: Shows the name of the item.

PUBLICATION: Displays the latest publications and date pertinent to the item.

SERVICE DATA: Heading for next section of the report.

ADMIN NUM: Self explanatory.

DATE SERVICE DUE: Reflects the date and type of service required.

INTERVAL DAYS: Shows days between services.

READING DUE: Shows K for kilometers or M for miles and reading for next service.

**Figure 3-46. Sample ULLS-generated AWCMF450 Report**

DATE: 20031201

COMMANDER'S FINANCIAL TRANSACTION LISTING

DOCUMENT NUMBER	DESCRIPTION	ADMIN NUMBER	QUANTITY	PRIORITY	EXTENDED PRICE
W33VT5 3330 2300	YOKE, UNIVE	PLL	00001	05	\$ 927.00
W33VT5 3330 2301	FEEDER, AUT	PLL	00001	05	\$ 26753.99
W33VT5 3330 2302	CONTROL BO	PLL	00001	05	\$ 36973.99
W33VT5 3330 2304	CANISTER, C	NBC	00099	12	\$ 1133.55
W33VT5 3330 2305	FACEPIECE	NBC	00015	12	\$ 1635.00
W33VT5 3330 2306	CANISTER, C	NBC	00099	12	\$ 1133.55
W33VT5 3330 2307	CANISTER, C	NBC	00099	12	\$ 1133.55
W33VT5 3330 2308	DRINK TUBE	NBC	00001	12	\$ 4.01
			GRAND TOTAL	\$	69,694.64

Legend for Figure 3-47;

completion instructions follow. This report provides a listing of all requests, since the last time the commander's financial transaction listing was printed. The header information includes the date of the report.

DOCUMENT NUMBER. Self-explanatory.

DESCRIPTION. Reflects the Noun of the item requested.

ADMIN NUMBER. Reflects the admin number of the equipment item.

QUANTITY. Self-explanatory.

PRIORITY. Reflects the current price of the item.

EXTENDED PRICE. Reflects the extended price when ordering more than one item.

GRAND TOTAL. Self-explanatory.

**Figure 3-47. Sample ULLS-generated Commander's Financial Transaction Listing**

UIC SUPPORT UNIT NAME SUPPORT UIC CUSTOMER UNIT NAME CUSTOMER  
 WJATBO B CO 3 FSB WAQYTO HHC 3/7 INF

SHP BUMPER								NMC	FROM	TO	CURRENT		
WON	PD	CD	NO	NSN	MODEL	SERIAL NO	QTY	CAT	DATE	TIME	DATE	TIME	STATUS
				ORG WON/DOC	MALFUNCTION	EVAC WON							
A305016	02	X	HQ53	2350-01-369-6082 0310493	M1064A3 ENGINE BLOWN	C5 M33DOR3M4728	1	M	03321 0251	PRESENT	03321 0251		M
A305144	02	F		5855-01-228-0939 1310537	ANPVS7A W/N WORK	05084C	1		03316 0137	PRESENT			R
A305145	02	F		5855-01-228-0939 1310538	ANPVS7A BTY DOOR INOP	085297B	1		03316 0142	PRESENT			R
A305146	02	F		5855-01-228-0939 1310539	ANPVS7A BTY CMPRMT INO	55960A	1		03316 0148	PRESENT			R
A305147	02	F		5855-01-228-0939 1310534	ANPVS7A W/N FOCUS	085044B	1		03316 0152	PRESENT			R
A305148	02	F		5855-01-228-0939 1310540	ANPVS7A BTY COMPRTMNT	04957C	1		03316 0156	PRESENT			R
A305149	02	F		5855-01-228-0939 1310531	ANPVS7A BTY COMPRTMNT	087209B	1		03316 0159	PRESENT			R
A305150	02	F		5855-01-228-0939 1310532	ANPVS7A W/N TURMN ON	04883C	1		03316 0204	PRESENT			R
A305151	02	F		5855-01-228-0939 1310533	ANPVS7A W/N TURN ON	88710	1		03316 0209	PRESENT			R
A305152	02	F		5855-01-228-0939 1310536	ANPVS7A W/N TURN ON	087957	1		03316 0214	PRESENT			R
A305153	02	F		5855-01-228-0939 1310535	ANPVS7A W/N FOCUS	085246	1		03316 0218	PRESENT			R
A305154	02	F		5855-01-228-0939 1310530	ANPVS7A BTY COMPRTMNT	02276	1		03316 0221	PRESENT			R
A305192	02	F		5855-01-432-0524 1310558	PVS14 EYE PIECE BROKEN	20748	1		03317 1353	PRESENT			R
A305193	02	F		5855-01-432-0524 1310557	PVS14 W/NOT FOCUS	22551	1		03317 1355	PRESENT			R
A305194	02	F		5855-01-432-0524 1310554	PVS14 DOOR CRACKED	23534	1		03317 1356	PRESENT			1
A305195	02	F		5855-01-432-0524 1310555	PVS14 BTY CLMP BROKEN	22620	1		03317 1400	PRESENT			1

Notes:

<sup>1</sup> The customer compares the list with his or her open Maintenance Request Forms (DA Form 2407) to ensure agreement. This report is used to determine what was sent to the DSU and provides current work order status on the as-of date of the report. Entries are NOT REQUIRED for end items not having an odometer or hourmeter refer to figure 4-2 for a sample of completed DD Form 2026.

Legend for Figure 3-48;

completion instructions follow.

Figure 3-48. Sample SAMS-1 Customer Work Order Reconciliation

UIC SUPPORT. Support unit UIC.  
 UNIT NAME SUPPORT. Name of support unit.  
 UIC CUSTOMER. Shows the UIC of the customer activity.  
 UNIT NAME CUSTOMER. The customer unit name, the unit for whom the list is prepared.  
 WON. The 12-position SPTWON assigned to the work order by the supporting DSU.  
 PD. Priority Designator.  
 SHP CD. Shop Code.  
 BUMPER NO. Equipment bumper number.  
 NSN ORG WON/DOC. The NSN or other identifying number of the item at support maintenance.  
 MODEL MALFUNCTION. The model and/or the name of the item.  
 SERIAL NO EVAC WON. The serial number of the specific item at support maintenance.  
 QTY. The quantity of these items that were accepted for repair.  
 NMC CAT (Not Mission Capable Category). This column has 3 entries: NMCM-M, NMCS-S, or EVAC-E. Each time there is a status change, the NMC category prints along with the date/time. This information is used by SAMS to produce the MCSR and can be used to verify NMCM and NMCS time.  
 FROM DATE/TIME. The ordinal date (YYDDD) and time covered by the indicated NMC category.  
 TO DATE/TIME. The ordinal date (YYDDD) and time covered by the indicated NMC category.  
 CURRENT STATUS. The current status of the work order. Table B-21 lists these status codes.

**Figure 3-48. Sample SAMS-1 Customer Work Order Reconciliation**

PREPARED 06 SEP 02 TIME 1529		SAMS-2 EQUIPMENT DEADLINED OVER 000 DAYS BY BATTALION										PCN AHO-026	
		PART I - REPORTABLE ITEMS										REPORT SORTED BY: MODEL/AGE	
		UICS SELECTED FOR THIS REPORT = WA4FAA											
		EICS SELECTED FOR THIS REPORT = ALL											
UIC BATTALION	UNIT NAME BATTALION												
WA4FAA	2/9 INF BN												
WPN SYS MODEL OR NOUN/	SERIAL NUMBER	SYS DL	WO	STA	WON	MH-RMN	DATE	MALFUNCTION	ERC	*DAYS	DL*		
END ITEM MODEL OR NOUN	BUMPER NO	SERIAL NUMBER	CD	DATE		STATUS	DL	DESCRIPTION					
DOC NO	REPAIR PART NOUN AND NSN	QTY RQD	QTY OH	SRCE	PD	CD	DATE	MAINT LVL					
M120C	HQ56M 120-10452	ORG	00000	A4FT00807468			98090				1621		
		SPT 1	98093	AJDA0A806698		.0	98090						
MISSING ORG DATA													
WT4XBR80960050	BOLT, SHOULD	5306-01-299-5923	1	0	A	02	BB 98120	S					
WT4XBR80960051	NUT, PLAIN,	5310-01-292-7757	1	0	A	02	BB 98120	S					
M120C	HQ54M 10780	ORG	98127	A4FT00807541			98126	FAILED BORE SC	A		1585		
W90DL881274015	CANNON, 120	1015-01-410-7421	1	0	A	02	BB 98129	O					
M35A2	HQ411 0125-32855	ORG M	98127	A4FT00807545			98127	INJECTOR PUMP	A		1584		
		SPT B	98131	AJDA0A877071		12.0	98131						
M977	HQ467 8D1021182	ORG M	98118	A4FT00807531			98118	GSRP	A		1593		
NO SUPPORT STATUS RECEIVED													
M966	HQ6 032969	ORG M	98126	A4FT00807544			98126	ENG REAR MAIN	A		1585		
**NMC TIME STOPPED AT SUPPORT**													
RECORD NOT CLOSED BY ORG													
M966	HQ6 032969	ORG M	98132	A4FT00807553			98132	ENGINE LOCKED	A		1579		
		SPT A	98134	AJDA0A877073		12.0	98134						
M998	HQ15A 006019	ORG M	98107	A4FT00807518			98107	GSRP REQUEST	A		1604		
		SPT M	98119	AJDA0A806932		12.0	98110						
		BMA B	98119	000000000000		.0	98119						
M998	C7 006456	ORG I	98131	A4FC00802985			98131	BELTS V POWERS	C		1580		
W90DLP81314303	YOKE, UNIVE	2520-01-120-9805	1	0	A	02		O					
W90DLP81314302	GENERATOR	2920-00-909-2483	1	0	A	02		O					
W90DLP81314304	PULLEY, GRO	3020-01-198-0633	1	0	A	02		O					

Notes:

<sup>1</sup> Headings on the report reflect the number of days that the user determines for the query cutoff. Part I reflects reportable items and Part II reflects maintenance significant items. The formats for both parts are identical.

<sup>2</sup> Parts data follow below each WON.

Legend for Figure 3-49;

completion instructions follow.

UICs SELECTED FOR THIS REPORT. The selections made in the reports activity appear here.

EICs SELECTED FOR THIS REPORT. The selections made in the reports activity appear here.

UIC BATTALION. Unit Identification Code of the battalion (UIC BN).

UNIT NAME BATTALION. Unit name.

**Figure 3-49. Sample SAMS-2 Equipment Deadlined Over NNN Days by Battalion**

WPN SYS MODEL OR NOUN/END ITEM MODEL. Name or model number of the item of equipment (WPN SYS not shown on Part II). / Serial number of the weapon system/end item.

END ITEM MODEL OR NOUN BUMPER NO. Name or model number of the item of equipment. Bumper number is a locally assigned number used to identify the item.

SYS DL. Weapon System Deadlined Code for the item (not shown on Part II). Codes are: Y—Deadlined System (NMC), N—Not System Applicable (does not deadline system), P—Impairs system (partial mission capable). Aviation only; not currently used in SAMS.

SERIAL NUMBER. System serial number.

WO CD. The Work Request Status Code, indicating the status of work being done.

STA DATE. The Status Date indicates when the status code was last changed.

WON. Work Order Number, assigned to identify and track the maintenance request.

MH—RMN. Man-hours remaining. Estimate of the number of man-hours still required to complete the work order.

DATE DL. Date the item was deadlined at unit level or date accepted at support.

MALFUNCTION DESCRIPTION. A brief description of the problem.

ERC. Equipment Readiness Code of the item is a code used to show whether the item is: A—primary weapons and equipment (PWE), B—Auxiliary Equipment (AE), C—Admin Support Equipment (ASE), P—Pacing Item (item so important it is subject to continuous monitoring.)

DAYS DL. Total number of days (as of the prepared date) the item has been deadlined. The following parts data fill follow each work order on subsequent lines.

DOC NO. Document number of the supply transaction requesting repair parts for the work order.

REPAIR PART NOUN AND NSN. Name and number of the repair part needed.

QTY RQD. Quantity Required. Quantity of the part needed to accomplish the repair.

QTY OH. Quantity on hand. Quantity of the part available to issue to the work order.

SRCE. Supply source code indicates where the part comes from.

PD. Priority designator. Priority assigned to the supply transaction.

STATUS CD AND DATE. Last status of the supply transaction and the date the status was assigned.

ESD. Estimated shipping date. This is the estimated date the part will be shipped (if provided by the supply source).

MAINT LEVEL. Level at which maintenance is being performed: O—Organization, S—Support.

**Figure 3–49. Sample SAMS–2 Equipment Deadlined Over NNN Days by Battalion**

PREPARED 06 SEP 02 TIME 1531		SAMS-2 WORK ORDER STATUS AND PARTS LISTING										PCN AHO-032				
PD 01-03 WORK ORDERS OVER 2 DAYS OLD, PD 04-08 WORK ORDERS OVER 0 DAYS OLD, PD 09-15 WORK ORDERS OVER 0 DAYS OLD		UIC'S SELECTED FOR THIS REPORT = ALL														
WO STATUSES SELECTED FOR THIS REPORT = ALL																
TYPE MAINTENANCES SELECTED FOR THIS REPORT = ALL																
ECC'S SELECTED FOR THIS REPORT = ALL																
UIC SPT	WAJBAA	UNIT NAME	HHC/MMC	DISCOM												
SPT	WON	PD	ECC	MODEL OR NOUN	QTY	NSN	UIC	TYPE	UTIL	PROJ	DATE	WO	WO	AGE	EVAC	WON
ORGWON																
***	DENOTES RECEIPT	DOC NO	PART NSN	PART NOUN	RQD	ISS	DI	SRCE	CD	DATE	ESD					
AJBAAA701352	12	ZZ		ADAPTER, RECOIL	1	1605-01-221-0624	WHZZD0	1	0		97293	K	97293	1783		
*	HZZD00729301															
				W90CGA73210002	1005-01-182-7477	ROD, PISTON	3	0	0	A						
				W90CGA73300002	1005-01-182-7477	ROD, PISTON	3	0	0	A	BA	97330				
				W90CGA73220002	5330-00-166-0969	O-RING	12	0	0	A						
				W90CGA73300003	5330-00-166-0969	O-RING	1	0	0	A	BB	98005				
				W90CGA73220003	5330-01-395-3022	O-RING	12	0	0	A						
				W90CGA73300004	5330-01-395-3022	O-RING	12	0	0	A						
				W90CGA73510001	5330-01-395-3022	O-RING	12	12	0	A	RC	98037				
AJBAAA701354	05	ZZ		ROTOR, DISK BRAKE	1	1630-01-260-0747	WHZZD0	1	0		97294	M	97337	1782	HQAAAA718323	
*	HZZD00729401															
AJBAAA701398	02	ZZ		ADAPTER, RECOIL	1	1005-01-221-0624	WHZZD0	1	F		97317	B	97317	1759		
*	HZZD00731603															
AJBAAA701410	02	KH		ANASN143	1	6605-01-161-3919	WHZZD0	1	F		97317	M	97317	1759	W0YAAA702547	
*	HZZD00731602															
AJBAAA701419	02	ZZ		ALQ-144	1	5865-01-323-4999	WHZZD0	1	0		97322	M	97322	1754	W0QAAA718541	
*	HZZD00732107															
AJBAAA701461	02	10		TURRET CONTROL BOX	1	5930-01-398-1523	WHZZD0	1	0		97329	O	97329	1747		
*	HZZD00731862															
AJBAAA701466	02	AW		TADS TURRET	1	1270-01-307-9447	WHZZD0	1	0		97335	O	97335	1741		
*	HZZD00733562															
AJBAAA701486	02	10		CYLINDER ACTUATING	1	1650-01-158-0894	WHZZD0	1	0		97342	M	97343	1734	DYAAAA702750	
*	HZZD00734204															

Legend for Figure 3–50;  
completion instructions follow.

**Figure 3–50. Sample SAMS–2 Work Order Status and Parts**



UIC's SELECTED FOR THIS REPORT. ECCs/EICs selected for this report. The selections made in the reports activity appear here.  
 WO STATUSES SELECTED FOR THIS REPORT. The selections made in the reports activity appear here.  
 TYPE MAINTENANCES SELECTED FOR THIS REPORT. The selections made in the reports activity appear here.  
 ECCs SELECTED FOR THIS REPORT. The selections made in the reports activity appear here.  
 UIC SPT and UNIT NAME. Support UIC and name or unit UIC and name. UICs and Unit names are printed in alpha numeric order with accompanying work order and parts data following.  
 SPTWON and ORGWON. The work order number of the item being repaired. The accompanying ORWON is listed underneath this number.  
 PD. The priority designator shows the priority assigned to the maintenance request by the supported unit (01-15).  
 ECC. The equipment category code of the item being repaired.  
 MODEL OR NOUN. The model or noun of the item being repaired.  
 QTY REC. Quantity received. The number of items to be repaired under this WON.  
 NSN. National stock number of the item being repaired.  
 UIC CUST. The unit identification code of the customer owning the item being repaired.  
 TYPE MNT. Type maintenance to be performed. The code that designates the major maintenance action to be taken.  
 UTIL CD. Equipment utilization code is used to identify the purpose to which a reportable end item is applied by the reporting unit.  
 PROJ CD. The project code is used to identify requisitions and documentation related to a common purpose. Displayed if one has been assigned.  
 DATE ACPT. Date accepted. The ordinal date when this job was accepted at the maintenance facility.  
 WO STA and DATE. The current status and the date that the work order status change took place.  
 WO AGE. Work order age is the prepared date minus the date accepted (14).  
 EVAC WON. The WON assigned this job by the activity to which it was evacuated.  
 \*\*\*DENOTES RECEIPT. Refers to the first column where three asterisks denote receipt of item listed.  
 DOC NO. The document number of the part.  
 PART NSN. NSN of the part on order for the piece of equipment listed above it on the report.  
 PART NOUN. Name of the part on order.  
 \*\*\* QUANTITIES\*\*\* RQD, ISS, and DI. Quantities required, issued, and due in for this work order.  
 SRCE CD. Source code indicates where part comes from (for example, ASL or SSL).  
 STATUS CD, DATE. Supply status code and date of status.  
 ESD. Estimated shipping date. This is the approximate date the item will be shipped (if provided by source of supply).

**Figure 3-50. Sample SAMS-2 Work Order Status and Parts**

UNCLASSIFIED												
PREPARED	06 SEP 02	TIME	1526	SAMS-2 MAINTENANCE COST BY CUSTOMER							PCN AHO-022	
REPORT START DATE	02222	EIC'S SELECTED FOR THIS REPORT = AAB										
REPORT END DATE	02227	UIC SUPPORT	UNIT NAME SUPPORT	UIC CUSTOMER	UNIT NAME CUSTOMER							
WON	MODEL OR NOUN	EIC	WO QTY	MIL DIRECT MH	LABOR COST	CIV DIRECT MH	LABOR COST	TOTAL DIRECT LABOR COST	INDIRECT LABOR COST	REPAIR PARTS COST	TOTAL COST OF MAINTENANCE	
A304902	M1A1 TANK	AAB	001	2.2	\$16.90	0.0	\$0.0	\$16.90	\$3.38	\$16,996.00	\$17,016.28	

Legend for Figure 3-51;  
 completion instructions follow.  
 REPORT START DATE. The start date of the period for which this report was prepared. The SAMS-2 manager enters the proper dates for the period to be covered.  
 EIC'S SELECTED FOR THIS REPORT. Reflects EICs.  
 REPORT END DATE. The end date of the period for which this report was prepared. The SAMS-2 manager enters the proper dates for the period to be covered.  
 UIC SUPPORT. The support maintenance unit UIC.  
 UNIT NAME SUPPORT. The name of the support maintenance activity.  
 UIC CUSTOMER. The customer's unit identification code.  
 UNIT NAME CUSTOMER. The customer unit name.  
 WON. Work Order Number. The SPTWON assigned to each of the work orders.  
 MODEL OR NOUN. The item model or name.  
 EIC. The end item code for this item.  
 WO QTY. Work order quantity. The total number of items on each work order.  
 MIL DIRECT LABOR MH AND COST. The military man-hours worked and the labor cost totals for this WON.  
 CIV DIRECT LABOR MH AND COST. The civilian man-hours worked and the labor cost totals for this WON.  
 TOTAL DIRECT LABOR COST. Combines the military and civilian labor costs into one total.  
 INDIRECT LABOR COST. A percentage (determined by the maintenance activity) of overall cost, used to compute overhead expenses.

**Figure 3-51. Sample SAMS-2 Maintenance Cost by Customer**

REPAIR PARTS COST. All repair parts costs for the WON.

TOTAL COST OF MAINTENANCE. All costs for direct labor, indirect labor, and repair parts are added to produce a total cost of maintenance for this WON.

TOTALS. The SPTWON totals roll up to customer unit totals at the bottom of the page.

**Figure 3-51. Sample SAMS-2 Maintenance Cost by Customer**

---

## **Chapter 4**

### **AOAP Nonaeronautical Equipment, Processes, Forms, Records, and Procedures**

#### **4-1. AOAP objectives**

- a.* The AOAP is a condition-monitoring program designed to—
  - (1) Improve equipment reliability and readiness by early detection of potential failures.
  - (2) Lower support costs by reducing the number of catastrophic failures and curtailing excessive component wear.
  - (3) Reduce resource usage by conserving petroleum products by adhering to the On Condition Oil Change (OCOC) policy. (See policy in (4-1a(3)(a) through (d) below.)
    - (a) This policy eliminates the unnecessary changing of component oil based on hours/miles/calendar days as currently specified by many TMs and LOs. Oil will not be changed unless recommended by the AOAP laboratory. When recommended, oil will be changed and the oil filter(s) will be changed or serviced at the same time. Note that oil filter(s) will be cleaned/changed when they are known to be contaminated, or clogged; service is recommended by AOAP laboratory analysis; or at prescribed hard time intervals as described in LO or TM.
    - (b) When a unit is deployed and oil analysis service is not readily available, the unit reverts to the equipment oil change schedule listed in the equipment technical manual or LO. An oil sample is submitted to the laboratory as soon as AOAP service becomes available or the unit is redeployed, whichever comes first. The remarks block of DA Form 5991-E (Oil Analysis Request) and DD Form 2026 accompanying this sample to the laboratory is annotated to reflect the oil and filter change, because it may affect the trend analysis performed by the AOAP laboratory.
    - (c) The OCOC policy does not change or modify procedures and guidance for new equipment under manufacturers warranty or seasonal oil change requirements in current TMs and LOs.
    - (d) Additional information, including AOAP sampling procedures, is outlined in TB 43-0211.
- b.* An effective AOAP is possible only when the AOAP is fully integrated into the maintenance system. This chapter provides pertinent information and instructions to commanders and equipment users and encourages efficient performance of the AOAP.
- c.* AOAP is an effective maintenance diagnostic tool and not a maintenance substitute. This chapter should not be interpreted to mean AOAP minimizes, in any way, the need to employ good maintenance practices and strong maintenance discipline.
- d.* Additional information including AOAP sampling methods are outlined in TB 43-0211.

#### **4-2. Description**

- a.* Oil, hydraulic fluid, and grease analyses are used as diagnostic tools to determine the physical condition of used lubricants and the internal condition of engines, transmissions, hydraulic systems, and other fluid-wetted components.
- b.* Spectrometric analysis is used to determine the concentrations of various wear metals in oil samples. Wear metals are metal particles of microscopic size, produced by the friction of moving parts within mechanical systems, that enter the oil stream and are dispersed and suspended throughout the lubricating oil system. The kinds of metal particles and the quantities in which they are present are detected by spectroscopy. Analysis helps determine which component parts may have generated the particles. By periodically sampling and testing the lubricants from mechanical systems, abnormal wear can be detected, and worn parts can be repaired or replaced before they cause damage.
- c.* Physical property tests are analytical tests used to detect property changes in used oil. For example, changes in viscosity, fuel dilution, or water content may be indicative of faulty equipment, operating conditions, or maintenance procedures.
- d.* Ferrographic analysis is used as a supplemental oil analysis test on selected components to monitor wear metals that cannot be detected by spectrometric analysis. Ferrography is used not only to determine the size, shape, and type of wear-metal particles being generated by a piece of equipment, but also to determine the kind of wear (spalling, cutting, and rubbing) producing the wear-metal particles.
- e.* A resample is a sample specifically requested by the laboratory, of the same oil taken under the same condition as the previous sample.
- f.* Designated equipment/components are those enrolled in AOAP.

g. Contamination is a problem that most frequently affects sample integrity. Wear-metal, water, unusual color, and particular matter are indications of contamination.

h. Installation management reports are computer-generated reports provided by the laboratories to installation/unit monitors and others on a monthly or as requested basis.

#### **4-3. AOAP participation**

AOAP participation is mandatory for enrolled equipment, as prescribed in AR 750-1. AOAP responsibilities of commanders of major Army commands, the U.S. Army Reserve, the Army National Guard, equipment owning commands, and PM AOAP are defined in AR 750-1.

#### **4-4. What to sample**

The enrolled equipment/components listed in TB 43-0211, and other equipment/components authorized by the PM AOAP, will be sampled. Exceptions will be documented through letters of authorization from HQ, AMC. TB 43-0211 provides oil-sampling intervals for each component and detailed program operating procedures.

#### **4-5. When to sample**

a. At scheduled intervals, equipment-owning units will extract samples of lubricants from enrolled equipment and submit the sample to AOAP laboratories for analysis. Equipment users will complete DD Form 2026 (see TB 43-0211) and submit the form with the sample to the AOAP laboratory. Units equipped with the Unit Level Logistics System may submit the automated DA Form 5991-E (fig 4-1) with the sample, in lieu of DD Form 2026 (fig 4-2). Detailed program operating procedures are outlined in TB 43-0211.

b. AOAP laboratories will analyze the lubricants and notify the unit of its findings.

c. When analytical test findings indicate a potential problem, the laboratory will forward a maintenance recommendation to the customer unit on DA Form 3254-R (Oil Analysis Recommendation and Feedback) (fig 4-3) (see TB 43-0211).

d. DA Form 2408-20 (Oil Analysis Log) (fig 5-15) will be maintained for each AOAP enrolled item of equipment. Unless directed by local requirements, AOAP participating units receiving and maintaining OASIS laboratory reports with data normally listed on DA Form 2408-20, are not required to maintain DA Form 2408-20.

#### **4-6. Maintenance feedback data**

a. Maintenance feedback is critical to the equipment failure analysis process. Every effort should be made to provide timely and accurate maintenance feedback to the laboratory.

b. Laboratory maintenance recommendations will be annotated on DA Form 3254. After personnel in the using unit have performed the laboratory-recommended inspection or maintenance action, they will complete the lower portion of DA Form 3254. Block 14 will be used to explain any diagnostics performed, discrepancies found, and actions taken to return the component to a serviceable condition. Also include in this block the PQDR/EIR number and work order number. DA Form 3254 will be returned to the laboratory within 5 working days after maintenance is accomplished.

c. If a component is evacuated for repair, a copy of the DA Form 3254 will accompany it along with other appropriate paperwork. The support maintenance or overhaul facility will record the maintenance accomplished on the DA Form 3254, and return it to the originating laboratory within 5 working days after maintenance is accomplished.



OIL ANALYSIS REQUEST						
TO	OIL ANALYSIS LABORATORY FORT BRAGG					
FROM	MAJOR COMMAND FORSCOM					
	OPERATING ACTIVITY (Include ZIP Code/APO/UIC) A CO, 313TH MI BN FORT BRAGG, NC 28301 WA77A0					
EQUIPMENT MODEL ENGINE CAT-3116-290						
EQUIPMENT SERIAL NUMBER 3R501181						
END ITEM MODEL/HULL NUMBER M1083						
END ITEM SERIAL NUMBER BT 3845 BCJ						
DATE SAMPLE TAKEN (Day, Mo., Yr) 18 AUG 00				LOCAL TIME SAMPLE TAKEN N/A		
HOURS/MILES SINCE OVERHAUL 50 HRS						
HOURS/MILES SINCE OIL CHANGE 50 HRS						
REASON FOR SAMPLE <input checked="" type="checkbox"/> ROUTINE <input type="checkbox"/> LAB REQUEST <input type="checkbox"/> TEST CELL <input type="checkbox"/> OTHER (Specify)						
OIL ADDED SINCE LAST SAMPLE (Oz, Pts, Qts, Gals) 0						
ACTION TAKEN						
DISCREPANT ITEM						
HOW MALFUNCTIONED						
HOW FOUND <input type="checkbox"/> LAB REQUEST <input type="checkbox"/> AIR OR GROUND CREW						
HOW TAKEN <input checked="" type="checkbox"/> DRAIN <input type="checkbox"/> TUBE		SAMPLE TEMPERATURE <input checked="" type="checkbox"/> HOT <input type="checkbox"/> COLD		TYPE OIL 15W40		
ENGINE POSITION: NAME: SGT J. LIN EMP NO:			REMARKS/MISC: MI 3486 PHONE: 555-1234 SIGNATURE: James Lin			
FOR LABORATORY USE ONLY						
SAMPLE RESPONSE TIME						
FE	AG	AL	CR	CU	MG	NA
NI	PB	SI	SN	TI	B	MO
ZN	LAB RECOMMENDATION					
SAMPLE NUMBER(S)				FILE MAINT	DATA SEQ	

DD FORM 2026, MAR 1999

PREVIOUS EDITION MAY BE USED.  
USAPA V1.00

Legend for Figure 4-2;

completion instructions follow. Vehicle administrative number (the bumper) may be annotated in the upper left hand corner for training purposes. *Note:* Entries are NOT REQUIRED for end items not having an odometer or hourmeter refer to figure 4-2 for a sample of completed DD Form 2026.

TO. OIL ANALYSIS LABORATORY: Name of supporting laboratory.

FROM. MAJOR COMMAND (U.S. Forces Command, Training and Doctrine Command (TRADOC), Eighth United States Army, and so on) full unit designation and address, and UIC, and OPERATING ACTIVITY.

Figure 4-2. DD Form 2026

EQUIPMENT MODEL. Nomenclature and model number of the component; for example, engine air cooled, V-engine configuration, diesel, superturbocharged, which would be shortened to AVDS; 1790-2A; Xmsn CD 850-6A; and Hydra Sys.

EQUIPMENT SERIAL NUMBER. Serial number of the engine or the components being sampled. On watercraft with twin engines, such as the LCM8s, identification consists of the serial number of the set and suffix identifying the particular engine. For example, the engines in serial number 12A7505-LD or LB, and 12A7485 are 12A7485-RD or RB.

END ITEM MODEL/HULL NUMBER. Self-explanatory.

END ITEM SERIAL NUMBER. End Item Serial Number and EIC.

DATE SAMPLE TAKEN. Self-explanatory.

LOCAL TIME SAMPLE TAKEN. Blank.

HOURS/MILES SINCE OVERHAUL. Cumulative number of hours/miles on the component since new or last overhaul.

HOURS/MILES SINCE OIL CHANGE. Number of hours/miles since last oil change on the component. If neither the component nor the end item has an odometer or hour meter, then the total estimated hours are entered.

REASON FOR SAMPLE. Applicable block is checked. When the reason is Other, such explanation is added under remarks. Initial sample, loss of engine power, or excessive smoke.

OIL ADDED SINCE LAST SAMPLE. Self-explanatory.

ACTION TAKEN. Blank.

DISCREPANT ITEM. Blank.

HOW MALFUNCTIONED. Blank.

HOW FOUND. Blank.

HOW TAKEN. Self-explanatory.

SAMPLE TEMPERATURE. Self-explanatory.

TYPE OIL. Self-explanatory.

ENGINE POSITION. Blank.

NAME. The individual who took the sample prints rank/grade, first initial and last name.

EMP NO: Users employee number if applicable.

REMARKS/MISC.

1. The odometer reading of the end item in which the component is installed, (Indicate whether the odometer reading represents miles (MI) or kilometers (KM). Readings are not converted from miles to kilometers or kilometers to miles.)

2. The end item hourmeter reading if the end item does not have an odometer; such as HRS 50.

3. If the end item has both an odometer and hourmeter, only the odometer reading is recorded.

4. Show total equipment usage (the current meter reading plus usage from replaced meter(s)). DD Form 314 (Remarks block) indicates if the equipment had a meter replaced and the usage of the old meter.

PHONE. Phone number of the point of contact.

SIGNATURE. The person taking the sample signs this block. Note, if the component is not installed in an end item, uninstalled is entered.

**Figure 4-2. DD Form 2026**

---

<b>OIL ANALYSIS RECOMMENDATION AND FEEDBACK</b> For use of this form, see TB 43-0106 and TB 43-0210; the proponent agency is DARCOM.		<i>REQUIREMENT CONTROL SYMBOL</i> USGLD - 1B18
1. TO: FIELD (Include ZIP Code and Telephone Number) COMMANDER 1ST BN 4INF ATTN: AOAP MONITOR	3. LAB RECOMMENDATION NUMBER  01-100-A213	
	4. END ITEM MODEL  M113A2	
	5. END ITEM SERIAL NUMBER  AAA17563XXX	
2. FROM: LABORATORY (Include ZIP Code) DIRECTOR USAREUR OIL ANALYSIS LABORATORY BAMBERG APO AE 09139	6. COMPONENT TYPE  ENGINE	
	7. COMPONENT SERIAL NUMBER  6D23456	
	8. COMPONENT TIME (Hours/Miles)  5000 HRS	
9. RECOMMENDATION AND REASON FOR ACTION RECOMMEND DO NOT OPERATE. EXCESSIVE FUEL CONTAMINATION IN OIL. POSSIBLE CAUSES: WORN INJECTION PUMP/LEAKING FUEL LINES/WORN INJECTORS/DEFECTIVE PREHEATER ASSEMBLY.  INSPECT AND REPAIR AS NECESSARY TO CORRECT PROBLEM. THEN CHANGE OIL FILTER (S) AND RESAMPLE AFTER 1- 2 HOURS OF OPERATION.		
10. SIGNATURE AND TITLE OF INITIATOR  I. M. GREISE, LAB CHIEF <i>I. M. Greise</i>	11. DATE (Day-Month-Year)  15 AUG 01	
12. NOTE FOR ARMY AVIATION ONLY: Quality Deficiency Report (QDR), SF 368, will be submitted when maintenance is performed due to impending or incipient failure indicated by oil analysis. Failure Code 916.	13. QDR NUMBER	
14. FEEDBACK (Maintenance Performed/Action Taken) INSPECTED AND DISCOVERED TWO CROSSOVER TUBES LEAKING. REPLACED TWO CROSSOVER TUBES. CHANGED OIL AND FILTER AND RESAMPLED.		
15. FROM: FIELD/DEPOT MAINTENANCE PERSONNEL  U. R. FIXED <i>U.R. Fixed</i>	16. DATE (Day-Month-Year)  29 AUG 01	
17. TO: LABORATORY DIRECTOR USAREUR OIL ANALYSIS LABORATORY BAMBERG, APO AE 09139	NOTE FOR ARMY AVIATION ONLY: Copy of this form with SF 368 (QDR) attached will be sent to: Commander, CCAD ATTN: DRSTS-MER, Stop 55 Corpus Christi, TX 78419	

DA FORM 3254-R, NOV 80

EDITION OF JUN 78 IS OBSOLETE.

USAPPC V1.00

Legend for Figure 4-3;

completion instructions follow.

BLOCKS 1 THROUGH 11. The laboratory completes these blocks.

13. QDR NUMBER. Aviation units complete block 13 for Failure Code 916.

Aviation units complete in accordance with instructions in block 12.

14. FEEDBACK (Maintenance Performed/Action Taken). Any diagnostics performed, discrepancies found, and actions taken to return the component to a serviceable condition is explained here. The following information, when applicable are included in this block. The PQDRs and EIR number and work order number.

15. FROM: FIELD/DEPOT MAINTENANCE PERSONNEL. Signature of the field depot maintenance representative preparing the report.

16. DATE (Day-Month-Year). The calendar date (DDMMYY) the report was completed.

17. TO: LABORATORY. Enter the supporting laboratory address.

Figure 4-3. DA Form 3254

## Chapter 5 Historical Processes, Forms, Records and Procedures Report Control Symbol (RCS) 1051

### 5-1. General information

*a.* Historical records are kept on specified items of equipment in accordance with AR 750-1, paragraph 3-5. The records show required information and events in the life cycle of the equipment.

*b.* These records may be paper, ledgers, and stored electronic records. The records are stored in the Army standard management information systems or Web accessible databases.

*c.* The records must be controlled and kept safe from loss or damage.

*d.* The records give commanders information on equipment transfers, gains, losses, usage, NSN redesignations/recapitalizations, vehicle overhauls, firing data, modifications, and the AOAP.

*e.* Historical records may be sent on dispatch. However, these records are normally sent on dispatch only when they are needed during the dispatch.

(1) A new form is not used until there is an entry needed on that form.

(2) A form is redone only when it has been lost or so damaged that it cannot be read.

*f.* Commanders may consolidate historical records in one or more binders.

*g.* Historical records are always filled out in ink or typewritten, unless the specific instructions for the form say to use pencil. Blue or black ink is used.

*h.* Historical records are automated in future Army maintenance STAMIS because of the critical nature of the information, and selected information is transmitted to LIDB.

### 5-2. Missing historical information or records

*a.* When none of these sources has the information needed, a letter or e-mail is sent to LOGSA to the Commander, USAMC Logistics Support Activity, ATTN: AMXLS-MD (TAMMS), Redstone Arsenal, AL 35898-7466. The e-mail address is tedb@logsa.army.mil. Provide the NSN, serial number, and registration number (if one has been assigned) for each item queried. LOGSA can usually provide the information for blocks 6, 7, 8, 9, 10, 11, and 12 of DA Form 2408-9 and the current owner. This information is based on the latest acceptance, transfer, AOAP, or usage reports submitted. If no reports were submitted, no information may exist. In that case, DA Form 2408-9 is completed. Unit information is entered in blocks 1, 2, 3, and 4.

(1) When the equipment comes from the Defense Logistics Agency or Defense Contract Administrative Services, units receiving the equipment fill out the required forms and send copies out as the paragraph on the form directs.

(2) When the equipment comes from an Army procurement activity, any needed information is obtained from the item manager. The equipments NSN on the AMDF should be noted. The FSC is the first four numbers in the NSN. Copies of the form are sent as directed.

(3) When the equipment comes from another Army activity, the needed information is obtained from the losing activity. Forms are sent as needed.

(4) The equipment data plate, property book office, and maintenance forms can sometimes be used to fill in the blanks on missing or damaged forms.

(5) If it is necessary to remake a DA Form 2408-9 because the original form was lost or damaged, all the information from the old form is moved to the new form. NEW FORM INITIATED and the date are written in the remarks blocks of the new form. If blocks 1, 2, 3, and 4 of the lost or damaged form are unknown, unit information is entered in these blocks. NMP copies of forms made to replace lost or damaged forms are discarded.

*b.* Components or assemblies should not be disassembled to see if an MWO has been applied or to determine how much usage they have had.

*c.* Items packaged and in storage at a supply activity should not be opened just to finish forms. The forms are completed when the item is issued.

### 5-3. DA Form 2408-4

*a.* DA Form 2408-4 is used to records firings and other information on the service life of weapons with cannon or mortar tubes. This information is important to safety (fig 5-1). The electronic 2408-4 is the preferred medium for recording all firing and nonfiring data for tank, artillery, and mortar tubes. The electronic gun card can be accessed from the Army Electronic Product Support home page at <https://aeprs.ria.army.mil/aeprspublic.cfm>.

*b.* DA Form 2408-4, used with TM 9-1000-202-14, provides the estimated remaining life of the tube, cannon serial number (the breech ring), and the weapon on which they are mounted. The electronic 2408-4 allows the same data to be recorded on line on a real time data base system. Use of the electronic 2408-4 negates the requirement to mail the completed 2408-4 to TACOM, Rock Island Arsenal, as outlined in paragraph 5-3j.



c. This form is used to figure the total EFC for the rounds. The electronic 2408-4 calculates EFC and remaining life.

d. A second DA Form 2408-4 is used solely to note zeroing and boresight information on the M1 and the Measured Correction and AFCS offsets of Azimuth, Elevation, and Roll on the M109A6 Paladin. The electronic form is used to enter nonfiring data such as boresight and pull over gauge readings. On Abrams tanks, the electronic form can be used to record zeroing and boresight information or a printed hard copy may be used to record this information.

e. A hard copy of DA Form 2408-4 is maintained with the gun, cannon, or mortar tube for operational purposes (when in use); to document rounds fired, to keep up with services pulled on a tube or capture other periodic maintenance inspections or actions taken. Appendix E indicates which items of equipment require this form.

f. The commander maintains hard copies of DA Form 2408-4 in a logbook binder for the purpose of keeping a working copy for dispatch, for firing or maintenance. The permanent record is entered into the electronic site each occasion the tube is fired or a nonfiring action is performed.

g. A hard copy may be printed from the electronic database as necessary. If historical information is needed from a DA Form 2408-4, it may be accessed from the Army Electronic Product Support (AEPS) database to obtain firing and nonfiring data from previously submitted information. If the information needed cannot be found, an e-mail is sent to [tacom-ri-gun-card-armor@ria.army.mil](mailto:tacom-ri-gun-card-armor@ria.army.mil) for tank information. For artillery information, an e-mail is sent to [tacom-ri-artillery-gun-card@ria.army.mil](mailto:tacom-ri-artillery-gun-card@ria.army.mil). For mortar information, an e-mail is sent to [tacom-ri-mortars-gun-card@ria.army.mil](mailto:tacom-ri-mortars-gun-card@ria.army.mil). When inquiring about specific cannon, the following information is included:

- (1) Tube serial number.
- (2) Cannon size, model or series.
- (3) Cannon serial number.
- (4) When the serial number, size, or model number is not available, all other information on hand is provided.

h. Entries on DA Form 2408-4 are made in blocks 10a through 10j by the section chief, crew chief, or someone designated in writing by the unit commander. These entries are made within 24 hours of firing.

i. The information on this form is critical to safety. All entries must be correct, add up, and be readable. The electronic 2408-4 makes the calculations.

j. If access to the AEPS Web site is not possible, a hard copy of DA Form 2408-4 is completed and mailed to TACOM, Rock Island, ATTN: AMSTA-LC-CIPPA, Rock Island, IL 61299-7630. Cards should be mailed in accordance with the following schedule.

- (1) Active Army units send in the form on 10 April and 10 October each year.
- (2) Reserve and National Guard units send in the forms on 10 October each year.
- (3) When mailing a card, a note is entered in the remarks block (column I) why the form is being sent in, such as April 1 report or condemned and the reason for the condemnation, if the tube is condemned.

(a) When the weapon is put in storage, transferred or turned in, the card is mailed if data cannot be entered into the AEPS system and a copy printed to forward with the weapon. A copy of DA Form 2408-4 is kept showing all the data from the form sent.

(b) A copy of DA Form 2408-4 goes with the weapon when it is evacuated for repair or maintenance, even if the data are entered in the AEPS database.

k. Support maintenance units enter the data into the electronic 2408-4 or mail in DA 2408-4 when—

- (1) The tube or cannon is condemned.
- (2) The tube, cannon, or weapon is lost to the Army inventory for any reason.

l. If access to AEPS is not possible, and before mailing DA Form 2408-4 to TACOM—Rock Island, the following must be done:

(1) A note in column i (Remarks) should be entered explaining why the form is being sent in. For example, 10 April report is written in column i for forms sent in on that date. “Condemned” is printed along with the reason in column i if the tube has been condemned. The date sent is entered in column a. The unit commander signs in column j.

(2) A new DA Form 2408-4 is started by bringing forward all necessary information. The unit commander signs in column j (fig 5-2).

m. A DA Form 2408-4 that shows only boresight and zero data, or Measured Correction and AFCS Offsets, is held until filled. When it is filled, the last boresight and zero information are entered on a new DA Form 2408-4. Boresight and Zero are printed in the top and bottom margins of the new DA Form 2408-4 (fig 5-3). The old DA Form 2408-4 is discarded.

#### **5-4. DA Form 2408-4 used for recording armament system and subsystems**

a. DA Form 2408-4 gives a record of firings and component replacements of the 25mm automatic gun and Air Defense Weapons Systems (figs 5-4, 5-5).

b. DA Form 2408-4 records the rounds fired on each armament subsystem and component. It is used when components are replaced, overhauled, or rebuilt on a rounds-fired basis. The armament system TM lists components handled on a rounds-fired basis.

- c. One DA Form 2408-4 is used for each weapon in a subsystem. One form is used for each weapon no matter how many barrels it has.
- d. Appendix E indicates what equipment requires DA Form 2408-4.
- e. Entries on this form are made by the section chief, crew chief, or someone designated in writing by the unit commander.
- f. This form is kept in a binder with all the unit's DA Forms 2408-4.
- g. This form is attached to the weapon when the armament subsystem is sent to support or depot, turned in or stored unmounted, and then placed in a protective cover.
- h. When the form is filled, needed information is entered on a new form. At the least the information from blocks 1 through 5, block 7, and the last entries in block 10 on the new form is entered. For the 25mm automatic gun, blocks 2 through 9 and the last entries in block 10 of the new form are completed.
- i. Completed forms are kept for 90 days or until another form is filled, whichever comes first. After information has been transcribed to a new DA Form 2408-4, the old form is kept for 90 days and then destroyed.
- j. When equipment is overhauled or rebuilt, DA Form 2408-4 is destroyed. A new form is started with zero rounds fired on it.
- k. Entries in blocks 1 and 3 are in pencil. The remainder of the form is completed in ink.

#### **5-5. DA Form 2408-5 (Equipment Modification Record)**

- a. DA Form 2408-5 (fig 5-6) is used to document changes to Army equipment (configuration) for both hardware and software. The MMIS is the preferred standard for recording all modifications that are developed, and applied to Army equipment. The electronic DA Form 2408-5 can be accessed from the Army Electronic Product Support home page at <https://aeps.ria.army.mil/aepspublic.cfm>.
- b. DA Form 2408-5 form shows published and applied MWOs.
- c. DA Form 2408-5 is a permanent record of—
  - (1) All equipment that lists DA Form 2408-5 in figures E-1 through E-4.
  - (2) Serial numbered missile components when an MWO applies to the component.
- d. A component NSN may be changed by an MWO. If the component is marked with the MWO number, a DA Form 2408-5 is not needed on the new item. A new form is started only when an MWO is issued for the item under its new NSN.
- e. DA Form 2408-5 lists all modifications required and reflects those that are completed:
  - (1) Blocks 1 through 4 show equipment and organizational information.
  - (2) Blocks 5 and 6 show data on required published modifications. This information is available from MWO, MMIS, or other sources.
  - (3) Blocks 7 through 9 show application data, man-hours, and the activity that applied the MWO. This information is available from DA Form 2407 or MMIS. The organization that applies the MWO usually makes the entries in this section.
    - (a) A DA Form 2408-5 is started only when an MWO has been issued on an item on hand that is listed in figures E-1 through E-4.
    - (b) MWO entries must be current. The MMIS and DA Form 2408-5 are the only historical records showing the current configuration of the equipment.
    - (c) When one MWO replaces another, the two publications are compared as follows:
      - 1. If the replaced MWO has been applied to equipment, the action is written up on DA Form 2408-5. If more work is needed on the new MWO, the replaced MWO entry is lined out. "Superseded by" is written in column 8 and (new MWO number) in column 9. New MWO information is entered in columns 8 through 14 on the next open line. The date the new MWO is required to be completed is entered in pencil in column 10. If no more work is needed for the MWO, columns 11 through 14 are completed on the new MWO.
      - 2. If the replaced MWO has not been applied, the replaced MWO entry is lined out on DA Form 2408-5. "Superseded by" is entered in column 8 and (new MWO number) in column 9. The new MWO information is entered in columns 10 through 14 on the next open line. The date the new MWO is required to be completed is entered in pencil in column 10.
    - (d) If an MWO is completed and cancelled, DA Form 2408-5 must show that information as follows:
      - 1. If the MWO has been applied and entries in blocks 10 through 14 have been made, no further action is taken.
      - 2. If the MWO has not been applied and entries are in columns 8 through 9, the publication that cancelled the MWO and the date it was cancelled are listed in column 10 with the words cancelled above it. In columns 1 and 12, the organization and PID of the activity making the entry are cited.
    - (e) If an MWO has been applied, but not entered on DA Form 2408-5, it is added to the form as follows:
      - 1. Columns 8 and 9 are filled in. The MWO provides the information for those blocks.
      - 2. In column 10, the date the MWO had been applied is entered.
      - 3. In column 13, the estimated man-hours listed in the MWO is entered.

4. In column 11, PCW (previously complied with) or whatever applies is printed. The name of the maintenance activity that verified that the MWO has been applied is then added.
5. The PID of the person who confirmed the MWOs in column 12 is entered.
6. The already applied MWO is reported on a DA Form 2407 or using MMIS. Paragraph 3–7 explains how to handle DA Form 2407.
  - (f) A completed MWO entry may be found on DA Form 2408–5 when the MWO has not been applied.
    1. The MWO entry is lined through.
    2. The MWO information is entered on the next open line in column 8 through 14. In pencil, the calendar date the MWO is required to be completed is noted in column 10.
    3. If an MWO that does not apply has been entered on DA Form 2408–5, the entry is lined through. “Not applicable” is entered in column 14 on the same line.
    4. If a change comes out on an MWO listed on DA Form 2408–5, draw a line through the entry. Enter the new information on the next open line.
    5. When a component or assembly that has a DA Form 2408–5 is removed for any reason to include evacuation to depot, the form is attached to that item and the form placed in a protective cover.
    6. When a component or assembly that has a DA Form 2408–5 is installed, the form is added to the missile system log.

### **5–6. Usage reporting through ULLS-G**

- a. Units operating with ULLS-G SCP 05 or greater are required to submit ground usage to LOGSA monthly using the AMSS end of period report process.
- b. Usage is reported through ULLS-G on all vehicles with a “Type Report Code” of “Y” in the MMDF. Appendix E of this pamphlet also provides usage-reporting information. Usage is reported through ULLS-G for all equipment with an X in columns “2408–9 USAGE” or “DD 2026 USAGE” in appendix E. Units review the actual equipment mileage/hours against the ULLS-G equipment usage report to identify and correct usage data inaccuracies prior to submitting to higher headquarters.
- c. Units produce the AMSS end of period report (which includes the monthly usage report) on the 16<sup>th</sup> of each month, or the closest working day after the 16<sup>th</sup>. Active Army units, Army National Guard, and Army Reserve units: The AMSS data must be received by LOGSA no later than midnight central standard time on the 19th day of each month. Units perform quarterly reconciliations between equipment data shown in units’ ULLS-G equipment data file and equipment data shown on unit property books to ensure data synchronization and accuracy.
- d. ULLS-G units supported by SAMS sends the monthly AMSS end of period report (which includes the monthly usage report) to the battalion. The battalion sends the data to the supporting SAMS site, where the data is forwarded to LOGSA via telecommunications.
- e. Units with ULLS-G that are NOT supported by SAMS send their monthly AMSS end of period report (which includes the monthly usage report) to the battalion level via e-mail or floppy diskette for battalion roll-up. The battalion sends the data directly to LOGSA via e-mail. The e-mail address for AMSS data is ridbdata@logsa.redstone.army.mil.
- f. Separate units who are not aligned with a battalion forward the monthly AMSS end of period report (which includes the monthly usage report) directly to the supporting SAMS site, where the data are sent to LOGSA. In a situation where a unit is not aligned with a battalion and is not supported by a SAMS site, data is forwarded directly to LOGSA via e-mail. The e-mail address for AMSS data is ridbdata@logsa.redstone.army.mil.

### **5–7. DA Form 2408–9**

- a. *Purpose.* DA Form 2408–9 gives maintenance managers at all levels a record of equipment acceptance and other inventory and maintenance data. It also tracks ownership, location, usage, transfers, gains, losses, and overhauls/rebuilds/recapitalizations. AR 710–3, chapter 5, controls registration numbers on specified Army vehicular equipment in order to be used on public roads and highways. The registration numbers of equipment is recorded on DA Form 2408–9.
- b. *Use.*
  - (1) This form is used to track equipment: acceptance, gains, losses, transfers, usage, overhaul, rebuilds, recapitalization, NSN changes, and registration number.
  - (2) Equipment requiring DA Forms 2408–9 are found in appendix E. Other equipment may need these forms when directed by HQDA or other command. AR 710–3, chapter 5, also has equipment requiring registration by equipment category. When both this pamphlet and AR 710–3 cover equipment, keep only one set of forms. Separate forms are not needed.
  - (3) LOGSA at Redstone Arsenal, AL, is responsible for maintaining the TAMMS equipment database (TEDB). DA Form 2408–9 is the prime source of information in support of the database. The database supports the Army’s budget, equipment procurement, operating tempo determinations, and provides data output summaries and reports in support of equipment age, ownership, asset position, usage, overhaul/rebuilds/recapitalization, and safety recall requirements. The TEDB is the repository of record for the Army Vehicle Registration Program. Requests for information are addressed

to Commander, USAMC Logistics Support Activity, ATTN: AMXLS-RRA, Redstone Arsenal, AL 35898-7466, or e-mailed to tedb@logsa.army.mil.

*c. Special information.*

(1) *Instructions and use.* DA Form 2408-9 instructions and use apply to all Army units, organizations, and activities as shown below.

(a) Army depots fill out and send in DA Forms 2408-9 even though the property accounts for depot stock are kept at the AMC major subordinate command level.

(b) The property book officer or the officer accountable for the property of the parent unit makes out DA Form 2408-9. Defense Reutilization and Marketing Offices (DRMOs) are not responsible for completing DA Form 2408-9 Loss Reports. Loss Reports are completed by the accountable officer of the unit of the owning organization prior to sending the equipment to DRMO. He or she is also responsible for distributing the copies to the appropriate elements and especially to LOGSA for the inclusion in the TEDB.

(c) For this pamphlet, a parent unit is one that owns equipment authorized under tables of organization and equipment (TOE) and the property book level for tables of distribution and allowances (TDA). For depot operating and mission stocks, the depot level is the parent unit. TOE separate companies that are not part of larger units are their own parent units.

(d) The maintenance officer is responsible for distributing copies of DA Form 2408-9 Usage Report when not reported by OASIS (AOAP) or AMSS.

(e) If a remark is needed on a DA Form 2408-9 because the original form was lost or damaged, move all the information from the old form to the new form. In the remarks block of the new form, print NEW FORM INITIATED and the date. If blocks 1, 2, 3, and 4 of the lost or damaged form are unknown, unit information is provided in these blocks. Throw away the NMP copies of forms made to replace lost or damaged forms.

(f) Serial numbers that have been assigned to an item are not changed during its life cycle, regardless of changes in configuration. The exception to this rule is for the correction of errors resulting in duplication of numbers. Any item declared as excess does not have its serial numbers destroyed or removed, in accordance with AR 750-1, para 3-6.

(2) *Electronic 2408-9.* Automated systems are now available and operational at LOGSA and take precedence over manual reporting of DA Form 2408-9. DA Form 2408-9 is located on the LOGSA Weblog: <https://weblog.logsa.army.mil>. Enter WebLOG using the WebLOG icon and look for the Asset Management column (right of the web page) and click on DA Form 2408-9. A password, which can be attained on the Web site by submitting a System Access Request, is required to access DA Form 2408-9 reporting. All data requirements to complete the form either manually or electronically are outlined in this pamphlet.

(3) *Acceptance and registration.* A DA Form 2408-9 is used when equipment needing this form is accepted into the U.S. Army inventory as shown below (fig 5-7).

(a) Equipment may be accepted on delivery from a manufacturer.

(b) Normally the Government representative at the manufacturing facility accepts equipment into the Army inventory, and the Acceptance Report is forwarded to LOGSA; however, some equipment may arrive from a manufacturer without a completed Acceptance Report. When this happens, the organization that discovers the need for the form fills out, distributes and submits a copy of the DA Form 2408-9 to LOGSA. This also applies when equipment is locally purchased.

(c) Use tables 5-1 and 5-2 to reduce required data for transmission to LOGSA.

**Table 5-1**  
**Data input format (acceptance and registration) code "G"**

Block	Field legend	Position from/to	Text length	A	N	A/N	Remarks
N/A	Control No.	1 6	6			X	
3	Unit ident code	7 12	6			X	
4	Utilization code	13	1			X	
5	Vehicle use code	14	1	X			
6	Nomenclature	15 34	20			X	
7	Model	35 49	15			X	
8	NSN	50 62	13			X	No dashes.
9	Serial no.	63 82	20			X	
10	Registration no.	83 92	10			X	
11	Year of MFG	93 96	4			X	
12	Manufacturer	97 101	5			X	
	Warranty period	102 116	15				
17	Report code	117	1	X			Enter A or B.
23	Julian date	118 122	5		X		

**Table 5-1**  
**Data input format (acceptance and registration) code “G”—Continued**

Block	Field legend	Position from/to	Text length	A	N	A/N	Remarks
N/A	Card code	123	1	X			Enter G.

Notes:

<sup>1</sup> Make sure all alphanumeric characters making up the serial number are listed, to include any preprinted prefix or suffix.

<sup>2</sup> Source: DA Form 2408-9, block 17. A and B are acceptable entries.

**Table 5-2**  
**Data input format (acceptance and registration) trailer (card code “H”)**

Block	Field legend	Position from/to	Text length	A	N	A/N	Remarks
N/A	Control No.	1 6	6			X	
13	Contract no.	7 30	24			X	
8	NSN	50 62	13			X	No dashes.
9	Serial no.	63 82	20			X	Note 1.
10	Registration no.	83 92	10			X	
14	Purchase order no.	93 107	15			X	Do not prefix with zeros.
N/A	Blank	108 122	15				Leave blank.
N/A	Card code	123	1	X			Enter H.

Notes:

<sup>1</sup> Make sure all alphanumeric characters making up the serial number are listed, to include any preprinted prefix or suffix.

<sup>2</sup> This transaction must accompany all Card Code “G” transactions.

<sup>3</sup> Source: DA Form 2408-9, block 17. A and B are acceptable entries.

(4) *Usage.*

(a) Units with the ULLS-G are no longer required to report usage on DA Form 2408-9. Units with ULLS-G now report usage monthly to LOGSA on all ground usage reportable equipment (as indicated by an X in the columns labeled “2408-9 USAGE” or “DD 2026 USAGE” in appendix E) by utilizing the Army Materiel Status System (AMSS) end of period report as outlined in paragraph 5-6.

(b) Units without ULLS-G or not enrolled in AOAP are still required to report usage on DA Form 2408-9 on equipment indicated in appendix E. A DA Form 2408-9 is used to report total miles or kilometers on the equipment. Equipment needing this report has DA Form 2408-9 usage specifically listed after the item in appendix E (fig 5-8).

(c) Usage reports (hardcopy only) are filled out on different dates as follows:

1. As of 1 October for nontactical vehicles.
2. As of 1 November for tactical vehicles.
3. As of 1 February and 1 August for floating craft.

(d) Appendix E identifies items on which usage data is to be reported. These items include tactical vehicles, selected items in the construction and support equipment categories, and selected wheeled vehicles listed as part of missile systems. This information is automatically provided through the ULLS-G AMSS process or AOAP. If neither of these systems is available, a hardcopy DA Form 2408-9 is still submitted for the periods shown in (4)(c) above.

(e) Usage Reports are needed on equipment both in use and in storage. This includes Army Prepositioned Stocks (APS) and war reserve stocks that have been used for a major exercise during the reporting period.

(f) Usage reports are NOT needed for uneconomically repairable vehicles awaiting disposition instructions from higher headquarters. Reports are not needed on tactical vehicles in a depot for repair. Those items have a condition code of M. Do not report tactical vehicles in stock that have a DD Form 1348 (DOD Single Line Item Requisition System Document (Manual)) issued for them.

(g) Use table 5-3 to reduce required data for transmission to LOGSA.

**Table 5-3**  
**Data input format (usage or overhaul) code “J”**

Block	Field legend	Position from/to	Text length	A	N	A/N	Remarks
N/A	Control No.	1 6	6			X	
3	Unit ident code	7 12	6			X	
4	Utilization code	13	1			X	
5	Vehicle use code	14	1			X	
7	Model	15 29	15			X	
8	NSN	30 42	13			X	No dashes.
9	Serial no.	43 62	20			X	See note 1.
10	Registration no.	63 72	10			X	See note 2.
11	Number of overhauls	73	1			X	See note 3.
11	Overhaul/rebuild						
11	Usage, overhaul or rebuild type action	74	1		X		See note 3. Must be B, H, or R.
11	Year of MFG	75 78	4	X			See note 3.
18b		79	1	X			Must be M or K.
17	Report code	80	1	X			Must be C, D, or V.
18a	Hours	81 86	6		X		Leave blank.
18b	Miles	87 92	6		X		Prefix with zeros.
18c	Rounds	93 98	6		X		Leave blank.
19	Filler	99 117					
23	Julian date	118 122	5		X		
N/A	Card code	123	1	X			Enter J

Notes:

<sup>1</sup> Make sure all alphanumeric characters making up the serial number are listed, to include any preprinted prefix or suffix.

<sup>2</sup> O & I (alpha) is entered as zero and one.

<sup>3</sup> Positions 73 and 74 will contain the number and type maintenance action except when the report is for usage when they will remain blank.

(5) *Transfers.* A Transfer report is needed each time equipment needing a DA Form 2408-9 is transferred by owning UICs as shown below (fig 5-9).

(a) After a reportable item is accepted into the Army inventory, and the item is transferred between owning UICs, a DA Form 2408-9 must be prepared and submitted by both the losing organization (report code 1) and the gaining organization (report code 2). Transportation activities, ports, and agencies involved in the shipment are not to be considered “owning UICs” but shipping activities ensure a copy of the transfer report is protected and on the equipment.

(b) A Transfer Report is NOT sent when the item is shipped or received on a loan basis. An item in installation supply that is marked for issue within 7 days is not reported. Transfer Reports are not needed as long as equipment stays on the unit property book or supply account, so a report is not needed when equipment is transferred within the same UIC or sent to a maintenance facility and returned to the user and no property book transfer is involved.

(c) When a unit is redesignated and/or the UIC of a unit changes, a letter is sent to the Commander, LOGSA, ATTN: AMXLS-RRA, Redstone Arsenal, AL 35898-7466 or e-mail is sent to tedb@logsa.army.mil. Both the old and the new UIC are included. The letter or e-mail acts as a Transfer Report for all equipment. The old UIC on the logbook copy of DA Form 2408-9 is lined through and the new UIC written above it.

(d) When an item is received that is to be entered into use (service) for the first time, the end item and major components are checked for a label stating that a warranty applies. If a warranty appears to apply, the Control Copy of the Received from Transfer Report is sent to the supporting WARCO. The WARCO adds the in-service date to the Remarks block of the form and forwards the form as directed by the particular warranty TB. If the TB has no instruction, the form is discarded.

(e) Table 5-4 is used to reduce required data for transmission to LOGSA.

**Table 5-4**  
**Data input format (transfer, gain, or loss) code "K"**

Block	Field legend	Position from/to	Text length	A	N	A/N	Remarks
N/A	Control No.	1 6	6			X	
3	Unit ident Code	7 12	6			X	
4	Utilization code	13	1			X	
5	Vehicle use code	14	1			X	
7	Model	15 29	15			X	
8	NSN	30 42	13			X	No dashes
9	Serial no.	43 62	20			X	See note 1.
10	Registration no.	63 72	10			X	See note 2.
11	Year of mfg	75 78	4			X	
	Filler	73 74					
17	Report code	80	1	X			See note 3.
18a	Hours	81 86	6		X		Prefix with zeros, may be blank.
18b	Miles	87 92	6		X		Prefix with zeros, may be blank.
18c	Rounds	93 98	6		X		Prefix with zeros, may be blank.
19/20	Unit ident code	99 104	6			X	
21	Old NSN	105 117	13			X	
23	Julian date	118 122	5		X		
N/A	Card code	123	1	X			Enter K

Notes:

<sup>1</sup> Make sure all alphanumeric characters making up the serial number are listed, to include any preprinted prefix or suffix.

<sup>2</sup> O&I (alpha) will be entered as zero and one.

<sup>3</sup> When block 17 equals "S" enter the new NSN in positions 30-42 and the report code "S" in position 80. Enter the old NSN in position 105-117 with the report code "M" from the remarks block.

<sup>4</sup> Source: DA Form 2408-9, block 17. S and M are acceptable entries.

(6) *Loss.* Send in a DA Form 2408-9 each time an item needing the form is lost to the Army inventory (fig 5-10). Losses can be physical or administrative. Send in Loss Reports when items are integrated into higher assemblies. A loss report is needed on each item going into a higher assembly when the items require a DA Form 2408-9 as shown in appendix E. A Loss Report is not prepared when equipment has been shipped from one unit/organization to another unit/organization; this is a Transfer Report (Code 1). Refer to table 5-4 for data reduction instructions and table B-15 for proper codes and definitions.

(7) *Gain.* Gain Reports cover items that come into the inventory from other than a manufacturer or local purchase (fig 5-11). Report equipment received from other services (Marine Corps, Air Force), property disposal offices, and so on, on a Gain Report. Send in a Gain Report on the new item when equipment is integrated into a higher assembly. Also, a Gain Report is sent in on an item taken out of higher assembly when the items require a DA Form 2408-9, as shown in appendix E. A Gain Report is not prepared when equipment has been received by the unit/organization from another unit/organization; this is a Transfer Report (Code 2). Refer to table 5-4 for data reduction instructions and table B-16 for proper codes and definitions.

(8) *Repair program for selected combat and tactical vehicles (fig 5-12).*

(a) A DA Form 2408-9 is required each time a selected combat or tactical vehicle is repaired under the continental United States (CONUS) Tactical Wheeled Vehicle Program, outside the continental United States (OCONUS) Theater General Support Repair Program (formerly the Transfer Army Repair Program, or other DA-approved programs requiring DA Form 2408-9 reports. Currently this pertains to vehicles repaired under the two programs mentioned above and performed only at GS shops, depots, or under contract. Items of equipment requiring DA Form 2408-9 are designated in the DA Form 2408-9 Repair column in appendix E. DA Form 2408-9 is prepared and submitted by the organization that performs the repair action.

(b) Use table 5-5 to reduce required data for transmission to LOGSA.

**Table 5-5**  
**Data input format (repair action) code "M"**

Block	Field legend	Position from/to	Text length	A	N	A/N	Remarks
N/A	Control no.	1 6	6			X	
3	Unit ident code	7 12	6			X	
4	Utilization code	13	1			X	
5	Vehicle use code	14	1			X	
7	Model	15 29	15			X	
8	NSN	30 42	13			X	No dashes.
9	Serial no.	43 62	20			X	See note 1.
10	Registration no.	63 72	10			X	See note 2.
	Filler	73 74	2	X			
11	Year of MFG	75 78	4		X		Enter calendar year.
17	Report code	80	1	X			Enter W.
18a	Hours	81 86	6		X		Prefix with zeros, may be blank.
18b	Miles	87 92	6		X		Prefix with zeros, may be blank.
18c	Rounds	93 98	6		X		Prefix with zeros, may be blank
	Filler	99 117	19				
23	Julian date	118 122	5		X		
N/A	Card code	123	1	X			Enter M

Notes:

<sup>1</sup> Make sure all alphanumeric characters making up the serial number are listed, to include any preprinted prefix or suffix.

<sup>2</sup> O&I (alpha) will be entered as zero and one.

<sup>3</sup> Source: DA Form 2408-9, block 17. W is an acceptable entry.

(9) *Overhaul.*

(a) Army depots and contractors who overhaul Army equipment report on a DA Form 2408-9 (fig 5-13). Overhaul Reports are sent in on all equipment needing a Usage Report. When the overhaul changes the NSN of an item, report the overhaul on the old NSN, not the new one.

(b) On the completion of an Overhaul Report, the date of overhaul and the name of the facility performing the action must be in block 21 of the logbook copy of the Acceptance or Gain Report. The number of the overhaul action is entered in block 11. An "H" for the overhaul, "R, for the rebuild, or "B" for the recap and the two-digit year of action are entered after the number. For an item whose action is in 2003, 1H03 is entered. If the first action was in 2001 and this action is in 2004, 2H04 is entered. If at the time of overhaul the odometer is NOT reset to "0" miles/kilometers (M or K), the odometer reading will be recorded in block 21 of the log book copy of the Acceptance or Gain Report.

(c) Table 5-3 is used to reduce required data for transmission to LOGSA.

(10) *NSN redesignation.*

(a) When for any reason the NSN of an item requiring a DA Form 2408-9 is redesignated/changed, the organization performing the maintenance action that changes the NSN prepares and sends in a DA Form 2408-9 reporting the change (fig 5-14).

(b) When the serial number and/or registration number does not change, one DA Form 2408-9 with a Report Code S (Gain) makes the change in NSN.

(c) When the NSN and the serial number and/or registration number change, two DA Forms 2408-9s are completed. A loss Report on the old item is sent using Report Code N. A Gain Report on the new information is sent using Report Code T. LOGSA is contacted for any serial number and/or registration number change. The serial number and/or registration number should only be changed if a correction is being made.

d. *Disposition.* DA Form 2408-9 is a multicopy form and distributed as follows should no electronic means be available:

(1) *NMP copy one.* This copy is sent to the Commander, LOGSA, ATTN: AMXLS-RRA (TAMMS), Redstone Arsenal, AL 35898-7466. Usage Reports must be sent within 30 working days after the report due date (see para 5-7c(4)(c)). Other reports must go in within 15 working days after the action. If DA Form 2408-9 is sent through a data processing center, a copy of the form is NOT sent to LOGSA. The information is sent from the data processing center electronically. Hard copies (the form) of Usage Reports on floating craft now go directly to the Commander, U.S. Army LOGSA, ATTN: AMXLS-RRA (TAMMS), Redstone Arsenal, AL 35898-7466.

(2) *Control copy two.*

(a) This copy is used or disposed of as local command or commander directs.

(b) For equipment under warranty, the control copy of Transfer Reports if forwarded to the warranty control office.

(3) *Logbook copy three.*



(a) "Permanent Log Book Copy" is written in block 21 of the Acceptance or Gain Report. These forms are kept in a binder of all the units DA Form 2408-9 Acceptance and Gain Reports.

(b) The latest Usage Report is kept until the next reports are sent in. A copy of the latest Usage Report goes with an item when it is evacuated to depot for overhaul.

(c) The Loss and Overhaul Report is discarded after overhaul information has been written in block 21 of permanent logbook copy of the Acceptance or Gain Report.

(d) The latest Transfer Report is kept until the next transfer action. When a Transfer Report (code 1, table B-14) is complete, the logbook copy goes with the vehicle. When a unit receives a vehicle, the Transfer Report (code 1) that came with it is destroyed when the Transfer Report (code 2) is made. If no current Transfer Report exists in the logbook binder, it is not reconstructed just for the purpose of complying with this paragraph.

(e) For items repaired under the Repair Program for selected combat and tactical vehicles, this copy of DA Form 2408-9 is maintained at the owning unit level in the equipment logbook binder. This copy should remain with the item of equipment throughout its life cycle.

(4) *Process and distribute the form.* Paragraph 5-7f and tables 5-1 through 5-5 tell ADP and data reduction activities how to process and distribute the form after data is reduced.

(5) *Integrated equipment.* When equipment is integrated into a higher assembly, only DA Form 2408-9 is kept on the higher assembly. The logbook copies of any DA Form 2408-9 reports on the items that went into the higher assembly are discarded.

*e. Corrections.* DA Form 2408-9 information is sent to LOGSA and is entered into a computer. A corrected copy of the original form is completed as shown below.

(1) "Corrected Copy" is printed in large letters across the front of the new form.

(2) The information from the old form is copied onto the corrected copy.

(3) The information to be corrected is entered on the corrected copy in block 21. and circled in red.

(4) The NMP copies of the forms are sent to the Commander, LOGSA, ATTN: AMXLS-RRA (TAMMS), Redstone Arsenal, AL 35898-7466. The actual form is sent. The information is NOT SENT through the data reduction center.

(5) The other copies of the corrected form are distributed as outlined in *d* above. All copies of the incorrect form are discarded.

*f. Data collection and submission.*

(1) *General.* These procedures apply to all units/organizations, under the jurisdiction of Headquarters, Department of the Army, submitting DA Form 2408-9 and are applicable to the collection, editing, reduction, processing of such data. Implementation of these procedures may require establishment of a control point, under the control of a command staff element such as the G-4. The control point would be responsible for these procedures and their submission per the timeframes established in paragraph 5-7d(1).

(2) *Responsibilities.*

(a) Unit, organization, and activity commanders are responsible for the accuracy and completeness of recorded information and timely submission of prescribed data.

(b) Major Army commanders provide necessary ADP data reduction facilities and trained personnel to accomplish prescribed operating functions.

(c) Commanders ensure that DA Forms 2408-9 are edited, corrected, and data reduced. Editing instructions are contained in figures 5-7 through 5-14. Data reduction instructions are in tables 5-1 through 5-5. When editing the form, ensure that blocks in figures 5-7 through 5-14 requiring entries are completed. Without these entries, the entire form rejects in the Army's logistics database and limits, if not eliminates, the record.

(3) *Inaccurate control numbers.* To correct inaccurate control numbers and adjust to the required six characters, the following action are taken:

(a) *Seven characters.* The first numeric character is deleted.

(b) *Five characters.* These are prefixed with an alpha X.

(c) *Duplicate numbers.* The first character for one of the forms is changed to an alpha X.

(4) *Different numbers on the copies of one form.* The control number is used on the NMP copy. The numbers on the other copies may be changed to establish and audit trail for local use.

(5) *Accepted methods of data submission.* After data has been thoroughly edited, it may be submitted to LOGSA by E-mail, or hard copy. Automated systems are now available and operational at LOGSA and are now the preferred order of submission. All data requirements to complete the form are outlined in the pamphlet still apply: E-mail specifications, 104 characters per record, ASCII Standard Data Format, file name "DA 2408-9.SDF" first record header. Positions are follows:

(a) Position 1-6 Submitting unit UIC.

(b) Position 7-40 Submitting unit POC.

(c) Position 41-53 POC Telephone number (DSN or COMM).

(d) Position 54-65 Data prepared.

(e) Position 66-70 Station Code.

- (f) Position 71–103 Organization/location.
- (g) Position 104 L.
- (h) Refer to tables 5–1 to 5–5 for the report formats. E-mail address is tedb@logsa.army.mil.
- (i) Place hard copy DA Forms in envelopes or boxes with a DA Form 200 (Transmittal Record) enclosed as prescribed below and securely sealed.

#### **5–8. DA Form 2408–20 (Oil Analysis Log)**

- a. *Purpose.* This form is a record of oil samples taken and lab analysis of those samples.
- b. *Use.* DA Form 2408–20 is used to record oil sample results for equipment enrolled in the AOAP. The equipment is identified in TB 43–0211. However, if the supporting AOAP laboratory is automated, and printout(s) with all the data from DA Form 2408–20 are received, DA Form 2408–20 is not required, unless directed by local standing operating procedures.
- c. *Disposition.*
  - (1) Hour meter changes and other needed information are transcribed to a new DA Form 2408–20 (fig 5–15). The completed DA Form 2408–20 is kept for 6 months after the last entry is made in column 4 then destroyed. The most recent printout is kept on hand until receipt of next printout (normally, the unit receives these printouts monthly).
  - (2) If a component requiring this form is removed for any reason, DA Form 2408–20 goes with the component. If the supporting AOAP laboratory is automated, a Component History printout showing the results of the last six samples goes with the evacuated component in place of DA Form 2408–20. The printout is given to the supporting AOAP laboratory at the new location. DA Form 2408–20 or a printout goes with items sent to depot for repair or overhaul. The printout is requested from the supporting laboratory prior to evacuation of the component.
- d. *Special instructions.*
  - (1) If the AOAP lab recommends that a warranty component be removed or maintenance action performed, the AOAP monitor contacts the supporting warranty control office. The warranty control office researches the warranty provision and gives permission to take the lab-directed action, take other action, or request the lab report used for a warranty claim.
  - (2) The warranty control office notifies the unit of disposition to take on warranted components affected by a warranty claim.
  - (3) The warranty control office notifies the unit when the warranty no longer applies. Lab-directed oil changes and other actions directed then apply.

#### **5–9. DD Form 1650 (Ammunition Data Card)**

- a. *Purpose.* This card gives a history of ammunition lots, explosive materiel, and serial numbered complete round guided missiles (fig 5–16).
- b. *Use.*
  - (1) When and how to use this form as a history of ammo, explosive materiel, and guided missile items is in MIL–STD–1168B.
  - (2) This DD Form 1650 is also used to keep up with changes of serial numbered components on selected missile systems. This pamphlet directs the use of DD Form 1650 as a component register for missile systems.
  - (3) DD Form 1650 is used to keep up with changes of serial numbered components on the TOW missile systems. Other missile systems coming into the inventory later may be added to this list.
- c. *Disposition.* The form is discarded as directed by a command Letter of Instruction on DD Form 1650.

#### **5–10. Equipment logbook binder (historical records)**

- a. Units keep all like historical forms in a binder (NSN 7510–00–889–3494). That is, all the units DA Form 2408–4 go in one binder. The units DA Form 2408–9 Transfer Reports go in one binder. When the combined forms are too large for one binder, they are divided into two or more binders.
- b. DA Form 2408–9 normally needs the following binders:
  - (1) Acceptance or Gain Reports.
  - (2) Transfer Reports.
  - (3) Usage Reports (Units with ULLS-G, this does not apply).
  - (4) Repair Reports.
- c. Equipment logbook binders may also be used to hold forms required on a missile system while on dispatch when more forms are needed than can be kept in an equipment record folder.
- d. Units with six or fewer items of equipment may keep like forms in a binder or keep all the forms on an item of equipment in a binder
- e. USAMC activities may also keep all the forms on an APS item of equipment in a binder.

## 5-11. Records that go with equipment

*a. General.* The following forms go with the equipment when it is—

(1) *Manufactured, assembled, overhauled, or rebuilt.* Depots and supply activities make sure the required forms are with the equipment in an equipment record folder or binder. A copy of DA Form 2404 used to show a technical inspection on the item also goes with the equipment.

(2) *Turned-in or transferred.* DD Form 314, as well as equipment records, goes with the equipment.

(3) *Sent to Defense Reutilization and Marketing Office (DRMO).* The organization or activity that has the equipment just before sending it to the DRMO or salvage handles the forms as follows:

(a) DA Form 2408-9 Loss Report (NMP copy) is sent to the Commander, LOGSA, ATTN: AMXLS-MD, Redstone Arsenal, AL 35898-7466. Automated systems are now available and operational at LOGSA and are now the preferred order of submission.

(b) DA Form 2408-20 and DA Form 2408-4 are sent with the equipment.

(c) DA Form 2408-9 logbook copies are destroyed.

(d) A copy of the most current DA Form 5988E/DA Form 2404 is sent with the equipment.

(4) *Fired missiles.* The missile log and all its records are sent to the Commander, AMCOM, Air Defense Systems or Land Combat Systems, ATTN: AMSAM-MMC-LS-MM, Redstone Arsenal, AL 35898.

*b. U.S. Army equipment on loan.* Send the records with equipment listed in appendix E when the equipment is loaned to other DOD agencies. Send the records with equipment loaned or contracted to other U.S. Government departments or agencies when directed to do so.

*c. U.S. Army equipment transferred.* U.S. Army equipment transferred to other U.S. Government departments and agencies is handled as follows:

(1) Send records with equipment transferred to other departments or agencies when directed to do so.

(2) DA Form 2408-9, Loss Report for equipment transferred to other departments or agencies is sent to the Commander, LOGSA as directed in paragraph 5-11a(3)(a). Automated systems are now available and operational at LOGSA and are now the preferred order of submission.

*d. Military assistance programs.*

(1) Records with equipment given to other nations under the military assistance program are sent as follows:

(a) A new DA Form 2408-4 with block 3 blank. All information must be current. The old form is sent to TACOM—Rock Island, AMSTA-LC-CIPPA, Rock Island, IL 61299-6000.

(b) DA Form 2408-9 Loss Report to Commander, LOGSA, ATTN: AMXLS-RRA (TAMMS), Redstone Arsenal, AL 35898-7466, as directed in 5-11a (3)(a).

(c) A DA Form 2408-5 for all MWOs applied.

(2) Any other forms are destroyed.

WEAPON RECORD DATA						REQUIREMENT CONTROL SYMBOL CSGLD-1051					
For use of this form, see DA PAM 750-8 and 738-751; the proponent agency is DCS, G4											
1. TUBE SERIAL NO. <b>23415</b>		2. CANNON TYPE, MODEL OR SERIES <b>155 MM, M185</b>		3. ORGANIZATION (UIC) <b>A-4/50TH FA WABLAQ</b>		4. SPECIAL LIFE DATA <b>6375</b> EFC RDS Life or 6.250 P.O., RECUF Pins <b>8107</b> Cum RDS, TORQUE KEY <b>3510</b> Cum RDS, Muzzle BRK + Bore EVC-REM + CIND <b>8209</b> + Quarterly. CRADLE BEARINGS LUBED <b>8209</b> CUM RDS.					
5. END ITEM IDENTIFICATION <b>HOW, MED, SP, 155MM, M109A3 SN: 1745</b>				6. RDS/EFC COMPUTATION							
7. CANNON SERIAL NO. <b>18911</b>				8. RETUBINGS <b>1</b> <b>6010EFC</b>		9. REBUSHINGS					
10. Date		Projectile Type	Zone or Charge	Rounds Fired	EFC RDS Fired	Cumulative RDS Fired	Cumulative EFC RDS	Remaining Life (EFC RDS)	Remarks: Recoil Exercise (RE), Gage or Velocity Reading, Safety Inspection (SI)	Signature	
<b>10 APR 00</b>		(Previous DA Form 2408-4 final entries)			<b>8028</b>	<b>1507.75</b>	<b>1343.25</b>	<b>206.00</b>	<b>3318.00</b>	<b>LAST (RE) 5 APR 00</b> BORE SP + GAGED P.O. <b>4A VE 7-14</b> <b>VE 4-1.2</b>	<b>William Emerick LT</b>
<b>20 APR 00</b>	<b>HEM107</b>	<b>3</b> <b>MAA1</b>	<b>7</b>	<b>1.75</b>	<b>8035</b>	<b>1509.50</b>	<b>1343.25</b>	<b>206.00</b>	<b>3316.25</b>		
	<b>SMM116</b>	<b>7</b> <b>MAA1</b>	<b>3</b>	<b>2.25</b>	<b>8038</b>	<b>1509.50</b>	<b>1345.50</b>	<b>206.00</b>	<b>3314.00</b>		
<b>2 JUL 00</b>											
<b>2 SEP 00</b>	<b>HEM 549A1</b>	<b>8</b> <b>MAA1</b>	<b>10</b>	<b>10.00</b>	<b>8048</b>	<b>1509.50</b>	<b>1345.50</b>	<b>216.00</b>	<b>3304.00</b>		
	<b>HEM 107</b>	<b>4</b> <b>MAA1</b>	<b>40</b>	<b>10.00</b>	<b>8088</b>	<b>1519.50</b>	<b>1345.50</b>	<b>216.00</b>	<b>3294.00</b>	<b>BORE SP + GAGED, A.O.</b> <b>L-134 SERVICABLE</b> <b>IAW</b> <b>TM 9-1000-202-14</b>	<b>William Emerick SSG</b>
<b>9 SEP 00</b>	<b>HEM 107</b>	<b>7</b> <b>MAA1</b>	<b>10</b>	<b>7.50</b>	<b>8098</b>	<b>1519.50</b>	<b>1353.00</b>	<b>216.00</b>	<b>3286.50</b>		<b>Mark Johnson SSG</b>
	<b>HEM 107</b>	<b>7</b> <b>MAA1</b>	<b>3</b>	<b>0.75</b>	<b>8101</b>	<b>1520.25</b>	<b>1353.00</b>	<b>221.00</b>	<b>3278.50</b>		
<b>2 OCT 00</b>	<b>HEM 107</b>	<b>8</b> <b>MAA1</b>	<b>5</b>	<b>5.00</b>	<b>8106</b>	<b>1520.25</b>	<b>1353.00</b>				<b>Franklin Brown SSG</b>
<b>10 OCT 00</b>										<b>10 OCT 00 REPORT</b> <b>NEW FORM</b> <b>INITIATED</b>	<b>Emerick LT</b>

DA FORM 2408-4, JAN 79

EDITION OF 1 DEC 77 WILL BE USED

USAPPC V1.00

Legend for Figure 5-1;  
completion instructions follow.

1. TUBE SERIAL NO. Enter the cannon tube serial number. TM 9-1000-202-14 shows where tube serial numbers are on cannons. For the 106mm Recoilless Rifle, enter the assembly serial number here.
2. CANNON TYPE, MODEL OR SERIES. The cannon type, model series, 105mm, M68, for example, or 155mm, M185, goes in this block.
3. ORGANIZATION (UIC). Owing organization name and Unit Identification Code (UIC). Pencil entry only.
4. SPECIAL LIFE DATA. Enter special life data on the specific weapon. Use this space to record EFC round life and other tube life information, when needed. Note any maintenance to be pulled on a round-fired basis (pencil entry). For the 106mm Recoilless Rifle, use this space to keep a total round count on the installed vent. For the 105mm, M68 Gun, compare the remaining EFC life of the breech mechanism assembly to the remaining life of the gun tube in column 10h. If the EFC life of the breech assembly is less than the entry in column 10h, print in column 10g, "Do not exceed (whatever the remaining breech mechanism EFC life is)."
5. END ITEM IDENTIFICATION. Enter the weapon end item identification, type series and model. For example, Howitzer, Medium, towed, M198 or Tank, Combat, M1A1. Also enter the end item chassis serial number in this block.
6. RDS/EFC COMPUTATION. Enter equivalent full charge (EFC) factors for various rounds here. TM 9-1000-202-14 gives EFC factor values. Write the zone figures above the sub columns in column 10g.
7. CANNON SERIAL NO. Enter the cannon serial number. TM 9-1000-202-14 shows where the cannon serial numbers (breech ring) are.
8. RETUBINGS. Divide this block into 2 sections by drawing a diagonal (slanted) line from the upper right to the lower left corner. In the first section, enter the number of times the installed breech ring has been retubed. See TM 9-1000-202-14 for details. If the initial tube is in the breech ring, enter a zero in this section. In the second section enter the total EFC rounds for the breech mechanism, for the 105mm, M68 Gun. For other equipment, in the second section, enter the total cumulative EFC rounds fired on the end item at the time of the last retubing. This figure is the total rounds on the whole system, the chassis or carriage, for overhaul.
9. REBUSHINGS. Enter the number of times the installed breech ring has been rebushed. For the 106mm Recoilless Rifle, enter the number of times the breech ring has been revented. Leave this block blank on weapons that do not require rebushing or reventing.
10. This block is divided into 10 columns, a through j.  
Date a. Write the calendar date when the action occurred. For example, 14 Aug 83. Do not use Julian dates.  
Projective Type b. Enter the type of projectile and cartridge model.  
Zone or Charge c. Enter the charge and zone number. Leave this column blank when it does not apply to weapons.  
Rounds Fired d. Write the number of rounds actually fired.  
EFC RDS Fired e. Multiply the rounds fired in column d by the EFC factor value for that type round or propellant.  
Cumulative RDS Fired f. Add the number of rounds fired in column 10d to the last entry made in column 10f.

Figure 5-1. Sample DA Form 2408-4

Cumulative EFC RDS *g*. Add the number in column 10e to the last entry made in column 10g in the sub column for the zone that applies to the rounds fired.

Remaining Life (EFC RDS) *h*. Subtract the EFC rounds fired in column 10e from the last entry made in column 10h. The difference between those two numbers is the remaining life of the cannon tube. Be very careful, recheck the figures, when making an entry in column 10h. Making a mistake in this column can put a life in danger.

Remarks *i*. Enter any remarks needed on the operation or maintenance of the weapon. This includes information on borescoping, gaging, velocity, pull over gauge readings and recoil exercises.

Signature *j*. The person designated by the unit commander to make entries on this form signs in this column. Enter both signature and rank or title here. When support personnel make entries, enter the support unit identity under the signature and rank. The unit commander signs in this column on the first line and last line entries.

Figure 5-1. Sample DA Form 2408-4

WEAPON RECORD DATA							REQUIREMENT CONTROL SYMBOL CSGLD-1051					
For use of this form, see DA PAM 750-8 and 738-751; the proponent agency is DCS, G4												
1. TUBE SERIAL NO. <b>23415</b>		2. CANNON TYPE, MODEL OR SERIES <b>155 MM, M185</b>			3. ORGANIZATION (UIC) <b>A 4/50TH FA WARQYN</b>			4. SPECIAL LIFE DATA <b>6375</b> EFC RDS LIFE OR <b>0.25</b> P.O., RECLP PINS <b>0107</b> CUM RDS, TORQUE KEY				
5. END ITEM IDENTIFICATION <b>HOW, MED, SP, 155 MM, M109A3</b> SN: <b>1745</b>					6. RDS/EFC COMPUTATION							
7. CANNON SERIAL NO. <b>18911</b>					8. RETUBINGS <b>601 EFC</b>		9. REBUSHINGS					
10. Date <b>10 OCT 00</b>		Projectile Type <i>(Previous DA Form 2408-4 final entries)</i>			EFC RDS Fired <b>8106</b>		Cumulative RDS Fired <b>1520.25 1353.00 221.00</b>		Cumulative EFC RDS <b>3270.50</b>	Remaining Life (EFC RDS) <b>0.25 0.75 1.00</b>	Remarks: Recoil Exercise (RE), Gauge or Velocity Reading, Safety Inspection (SI)	Signature <b>John Emrick 1LT (P)</b>
ZONE <b>1-6</b> <b>7</b> <b>0</b>												
EFC <b>0.25</b> <b>0.75</b> <b>1.00</b>												
9510 CUM RDS, MURBLE BRK 1 BORE EVC - RGM + CIND 0209 + QUARTERLY CRAPLE BEARINGS LUBED 0209 CUM RDS												
BORE ST 1 GAGED P.O. 6-124 SERVICABLE I.A.W. TM 9-1000-202-14												

CONTINUE ON REVERSE

DA FORM 2408-4, JAN 79

EDITION OF 1 DEC 77 WILL BE USED

USAPPC V1.00

Legend for Figure 5-2;  
completion instructions follow.

1. TUBE SERIAL NO. Enter the cannon tube serial number from previous 2408-4. (TM 9-1000-202-14 shows where tube serial numbers are on cannons.) For the 106mm Recoilless Rifle, enter the assembly serial number here.
2. CANNON TYPE, MODEL OR SERIES. The cannon type, model series, 105mm, M68, for example, or 155mm, M185, from previous 2408-4, goes in this block.
3. ORGANIZATION (UIC). Owing organization name and Unit Identification Code (UIC) from previous 2408-4.
4. SPECIAL LIFE DATA. Enter any special life data from the form to be sent in. EFC round life is entered here. Enter any information on maintenance to be done on a round count basis.
5. END ITEM IDENTIFICATION. Enter the weapon end item identification, type series and model. For example, Howitzer, Medium, towed, M198, or Tank, Combat, M60A1. Also enter the end item chassis serial number in this block.
6. RDS/EFC COMPUTATION. Enter equivalent full charge (EFC) factors for various rounds here. TM 9-1000-202-14 gives EFC factor values. Write the zone figures above the sub columns in column 10g.
7. CANNON SERIAL NO. Enter the cannon serial number. TM 9-1000-202-14 shows where the cannon serial numbers (breech ring) are.
8. RETUBINGS. Enter the information from both sections in the previous forms block 8. For 105mm M68 Gun, take the total EFC rounds for the breech mechanism from the previous forms block 8. Add the number to the difference between the first and last entries in column 10g of the previous DA Form 2408-4. Enter this number on the new form in the second section of block 8.
9. REBUSHINGS. Leave blank.
10. This block is divided into 10 columns, *a* through *j*.  
Date *a*. Enter the current date.

Figure 5-2. Sample DA Form 2408-4 with information to keep when sending a DA Form 2408-4

Projectile Type *b*. Leave blank.  
 Zone or Charge *c*. Leave blank.  
 Rounds Fired *d*. Leave blank.  
 EFC RDS Fired *e*. Leave blank.

Cumulative RDS Fired *f*. Enter the total rounds fired from the last entry in column 10f of the form to be sent in.

Cumulative EFC RDS *g*. Enter the total EFC rounds fired from the last entry in column 10g of the form to be sent in.

Remaining Life (EFC RDS) *h*. Enter the remaining life. Make sure this number matches the last entry in column 10h of the previous DA Form 2408-4.

Remarks *i*. Transfer any needed remarks from the previous form. For example, enter the date of the last borescope, special maintenance inspection, last pullover gauge reading, calibration (VE) and Recoil Exercise (R.E.).

Signature *j*. The unit commander signs in this column on the first line and last line entries. The unit commanders signature shows that all the information has been checked on the previous form and is correct. It also means all current and needed information has been transcribed to a new DA Form 2408-4.

**Figure 5-2. Sample DA Form 2408-4 with information to keep when sending a DA Form 2408-4**

*Boresight and Zero*

WEAPON RECORD DATA							REQUIREMENT CONTROL SYMBOL CSG.D. 1051		
1. TUBE SERIAL NO.		2. CANNON TYPE, MODEL OR SERIES			3. ORGANIZATION (UIC) <b>WAAQYN</b>		4. SPECIAL LIFE DATA		
5. END ITEM IDENTIFICATION <b>Tank Combat, M1</b>					6. RDS/EFC COMPUTATION				
7. CANNON SERIAL NO.			8. RETUBINGS		9. REBUSHINGS				
Date <i>a</i>	Projectile Type <i>b</i>	Zone or Charge <i>c</i>	Rounds Fired <i>d</i>	EFC RDS Fired <i>e</i>	Cumulative RDS Fired <i>f</i>	Cumulative EFC RDS <i>g</i>	Remaining Life (EFC RDS) <i>h</i>	Remarks: Recoil Exercise (RE), Gauge or Velocity Reading, Safety Inspection (SI) <i>i</i>	Signature <i>j</i>
<i>(Previous DA Form 2408-4 final entries)</i>									
20 Jan 97	HEP-T M456							Periscope Elev U6D M3221 Trav LR4	Redus Little SSG
20 Jan 97	HEP-T M456							Telescope UDI M145D Trav L3 R	Mark Carlson SFC
30 Jan 97	APDS-T M728							Periscope Elev U5D M3221 Trav L R3	Jon Martin SSG

CONTINUE ON REVERSE

**DA FORM 2408-4** (JAN 79) EDITION OF 1 DEC 77 WILL BE USED

Legend for Figure 5-3;  
 completion instructions follow.

1. TUBE SERIAL NUMBER. Leave blank.
2. CANNON TYPE MODEL OR SERIES. Leave blank.
3. ORGANIZATION (UIC). Enter the Unit Identification Code (UIC).
4. SPECIAL LIFE DATA. Leave blank.
5. END ITEM IDENTIFICATION. Enter the weapon and item identification, type series and model.
6. RDS/EFC COMPUTATIONS. Leave blank.
7. CANNON SERIAL NUMBER. Leave blank.
8. RETUBINGS. Leave blank.
9. REBUSHINGS. Leave blank.
10. This block is divided into columns *a* through *j*:  
 Date *a*. Write the calendar date when the action occurred.  
 Projectile Type *b*. Enter the type of projectile and cartridge model.  
 Zone or Charge *c*. Leave blank.  
 Rounds Fired *d*. Leave blank.

**Figure 5-3. Sample DA Form 2408-4 used for boresight and zero**

EFC RDS Fired e. Leave blank.

Cumulative RDS Fired f. Leave blank.

Cumulative EFC RDS g. Leave blank.

Remaining Life EFC RDS h. Leave blank.

Remarks i. For M1, enter boresights and zero information. For M109A6 Paladin, enter Measured Correction and AFCS offsets. Record all boresight and zero data for different type ammunition being fired. For M109A6, enter Measured Correction and AFCS offsets each time a Fire Control alignment is performed.

Signature j. The person doing the boresight and zeroing signs and enters rank.

Figure 5-3. Sample DA Form 2408-4 used for boresight and zero

WEAPON RECORD DATA										REQUIREMENT CONTROL NUMBER (NSAID - 951)	
For use of this form, see DA PAM 750-8 and 738-751; the proponent agency is DCS, G4											
1. TUBE SERIAL NO.		2. CANNON TYPE, MODEL OR SERIES			3. ORGANIZATION (UIC)			4. SPECIAL LIFE DATA			
		Gun, 25mm, M242			ECO 1/29 Inf W2L58K			Replace Breech 25000 Rds			
5. END ITEM IDENTIFICATION					6. RDS/EFC COMPUTATIONS						
M3, CFV, SN 1245					All rounds have an EFC of 1.0					Replace Firing Pin (PN 12524325) 8000 Rds	
7. CANNON SERIAL NO.		8. RETUBINGS		9. REFINISHINGS							
Rcc #364		0		0							
10. Date	Projectile Type	Zone or Charge	Rounds Fired	EFC RDS Fired	Cumulative RDS Fired	Cumulative EFC RDS	Remaining Life (EFC RDS)	Remarks: Recal Exercise (REL, Gauge or Velocity Reading, Safety Inspection (SI))	Signature		
10 Feb 97					0		25000 8000		John Tracy CPT		
12 Feb 97	AP		550		550		24450 7450		Tom Ross SSG		
15 Mar 97	HE		950		1500		23500 6500		Scott Ball SFC		
15 Jun 97	HE		2500		4000		21000 4000		Robert Spaldin SSG		
8 Jul 97	AP		4000		8000		17000 -0-		Tom Ross SSG		
8 Jul 97							17000 8000	8 Jul 97 - New Firing Pin Installed - 17000 Rds	Tom Ross SSG		
8 Jul 97								New Form Initiated	John Tracy CPT		

CONTINUE ON REVERSE

**DA FORM 2408-4** 1 JAN 79

Notes:

1 When DA Form 2408-4 is filled up and after the information has been transcribed to a new DA Form 2408-4, keep the old form for 90 days, and then destroy.

2 When it is necessary to replace the entire weapon, forward the up-to-date DA Form 2408-4 with the unserviceable weapon.

Legend for Figure 5-4;

completion instructions follow.

1. TUBE SERIAL NUMBER. No entry required.
2. CANNON TYPE MODEL OR SERIES. Enter Gun, 25mm, M242.
3. ORGANIZATION (UIC). Enter owning organization name and unit identification code.
4. SPECIAL LIFE DATA. Dry fire is currently not accounted for. Entry for dry fire accountability is no longer required. If an individual unit desires to keep this information, it is its decision. Enter replace breach at 25,000 rounds and replace firing pin (PN 12524325) at 8,000 rounds, and (PN 12524512) every 12,000 rounds.
5. END ITEM IDENTIFICATION. Enter the vehicle identification, Model and vehicle chassis serial number. Example: M3 CFV, serial number 1245.
6. RDS/EFC COMPUTATIONS. Enter all rounds that have an EFC of 1.0.
7. CANNON SERIAL NUMBER. Enter serial number of receiver.
8. RETUBINGS. Note this block is used for accountability of firing pins as replacement occurs. If the initial pin is in the gun, place a zero in this block. Upon first pin replacement, the zero is changed to a 1 and so on. When a pin is replaced, a note is placed in column 10i (remarks) to include date pin was changed and total rounds on weapon at the time of pin replacement. The remaining life column, 10h lower portion, has 8,000 or 12,000 placed in it at time of pin replacement to reflect the remaining life of the new pin.

Figure 5-4. Sample DA Form 2408-4 used for a 25mm automatic gun

9. REBUSHINGS. Note this block is used for accountability of breach as it is replaced. If the initial breach is in the gun, place a zero in this block. Upon first breach replacement, the zero is changed to a 1 and so on. When a breach is replaced, a note is placed in column 10i (remarks) to include date breach was changed and total rounds on the weapon at the time of replacement. The remaining life column, 10h, upper portion, has 25,000 placed in it at the time of breach replacement to reflect remaining life of the new breach.

10. This block is divided into columns a through j:

Date a. Enter current date.

Projectile Type b. Enter the type of round fired.

Zone or Charge c. No entry required.

Rounds Fired d. Enter number of rounds fired.

EFC RDS Fired e. No entry required.

Cumulative RDS Fired f. Add the number of rounds fired (last entry 10d) to the last of this column.

Cumulative EFC RDS g. No entry required.

Remaining Life h. This block is divided into two sections by drawing a horizontal line from side to side in the middle of the block. The upper portion contains the rounds remaining for the breach and the lower portion contains the rounds for the firing pin. Each time, an entry is made in 10d, the same entry is subtracted from the last entry for the breach and firing pin in 10h. This subtraction yields the remaining life in rounds of each of the two parts. When a part is replaced, the remaining life block shows this by adding either 8,000 or 25,000 in the appropriate portion of this block.

Remarks i. This column is used for replacement information as described in paragraphs 8 and 9.

Signature j. The unit commander signs in this column on the first and last entries. The unit commanders signature shows that the information on the previous form has been checked and found correct. Also, that all current and necessary information has been transcribed to a new DA Form 2408-4. The person designated by the unit commander signs name and rank on the entries between the commanders two signatures.

Figure 5-4. Sample DA Form 2408-4 used for a 25mm automatic gun

WEAPON RECORD DATA										REAR BREACH LIFE CYCLE NUMBER (USED 25K)	
For use of this form, see DA PAM 750-8 and 738-751; the proponent agency is DCS, G4											
1. TUBE SERIAL NO.		2. CANNON TYPE, MODEL OR SERIES			3. ORGANIZATION (UIC)			4. SPECIAL LIFE DATA			
Φ314		Cannon, 20mm, M168			"A" Battery, 1/3 ADA			144,800			
5. END ITEM IDENTIFICATION					6. THIS EFC RDS APPLICATION						
Gun, ADA, SP, 20mm, M163A1											
7. CANNON SERIAL NO.		8. REBUSHINGS		9. REPAIRS/REPAIRS							
10000234											
10. Date	Projectile Type	Zone or Charge	Rounds Fired	EFC RDS Fired	Cumulative RDS Fired	Cumulative EFC RDS	Remaining Life (EFC RDS)	Remarks, Recol Exercise (RE), Gauge or Velocity Reading, Safety Inspection (SI)	Signature		
a	b	c	d	e	f	g	h	i	j		
1 Feb 97					32,450		111,550	Barrels gauged at Φ30 (serviceable)	Lee Cantu SPC		
2 Feb 97			2,370		34,820		109,180		John Warner SSG		

CONTINUE ON REVERSE

DA FORM 2408-4

USE PREVIOUS EDITIONS WILL BE USED

Legend for Figure 5-5;

completion instructions follow. Draw a line below columns a through j after each days entries. Complete blocks 1 through 7, 10a, f, h, i and j when forwarding information to a new form.

1. TUBE SERIAL NO. Enter the serial number of the end item listed in block 5. Pencil entry.

2. CANNON TYPE, MODEL OR SERIES. Write Cannon, 20mm, M168.

3. ORGANIZATION (UIC). Enter the unit organization. Pencil entry.

4. SPECIAL LIFE DATA. Enter the life cycle of the cannon, for example, 144,000.

5. END ITEM IDENTIFICATION. Enter end item nomenclature, that is, Gun, ADA, SP, 20mm, M163A1, or Gun, ADA, Towed, 20mm, M167A1.

Figure 5-5. Sample DA Form 2408-4 used for the Air Defense Weapon System





5. UIC. List the Owning unit UIC.
6. END ITEM/AIRCRAFT SERIAL NUMBER. List the complete serial number of the item. Make sure ALL alphanumeric characters making up the serial number are listed, to include any preprinted suffix or prefix.
7. REGISTRATION NUMBER. Enter the registration number if known, otherwise leave blank.
8. MATERIEL CHANGE NUMBER. Enter the Materiel Change Number (MCN) for the Modification work order that is applied to the end item. Example 9-01-22-1245.
9. MWO NUMBER. Enter the complete MWO number.
10. DATE OF APPLICATION. Enter the date the MWO was applied to the end item. Enter the date as year, month, day. Example: 20021103.
11. ORGANIZATION APPLYING MWO. Enter the organization that applied the MWO. Example: 202nd Maint Company, (WB1ZAT). Include the name of the organization and UIC. If a contractor applies the MWO, enter the contract number.
12. NAME OR PID. Enter the name or the Personal identification number (PID) of the inspector performing the final quality control inspection of the MWO application.
13. MANHOURS REQUIRED FOR APPLICATION. Enter the actual man-hours required to apply the MWO. Round to the nearest tenth of an hour.
14. SOFTWARE VERSION. Enter the software version if the MWO resulted in the replacement of software to the end item. Example: Version 2.2 or SCP 2.4.

Figure 5-6. Sample DA Form 2408-5

CONTROL NO. <b>L 053757</b>	1. ORGANIZATION <b>DCMC, STEWART &amp; STEVENSON</b>	2. LOCATION <b>SEALY, TX 77474</b>	3. UNIT IDENT CODE <b>WIWLAA</b>	4. UTILIZATION CODE <b>U</b>	5. VEHICLE USE CODE
6. NOMENCLATURE <b>TRK CGO</b>		7. MODEL <b>M1083 WO/W</b>	8. NATIONAL STOCK NO. <b>2320-01-354-3386</b>	9. SERIAL NO. <b>BT3733BCJE</b>	10. REGISTRATION NO. <b>NL16M</b>
11. YEAR OF MFG <b>M96</b>	12. MANUFACTURER (MFG Code) <b>STEW &amp; STEV OFW39</b>	13. CONTRACT NO. <b>DAAE07-92-C-R001</b>	14. PURCHASE ORDER NO.		15. WARRANTY PERIOD
16. <b>TRK REPORT</b>		17. REPORT CODE <b>A</b>	18. USAGE		FOR PASSENGER CARRYING AND GENERAL PURPOSE VEHICLES COMPLETE BOTH 4 AND 5
a. ACCEPTANCE AND...			a. HOURS		
b. USA			b. MILES		
c. TR			20. RECEIVED FROM		
d. LOSS			a. ORGANIZATION		
e. GAIN			b. RECEIVED FROM UIC		
f. OTHER			c. ROUNDS		
21. REMARKS <b>"PERMANENT LOGBOOK COPY"</b>					
TELEPHONE NUMBER (DSN OR COMMERCIAL) OF INSPECTING OFFICIAL					
22. INSPECTOR'S SIGNATURE <b>Sandra A Lore (205) 955 9708</b>				23. JULIAN DATE <b>7097</b>	
<b>EQUIPMENT CONTROL RECORD</b>				<b>REPORTS CONTROL SYMBOL</b>	
<small>For use of this form, see DA PAM 750-8; the proponent agency is DCS, G4</small>				<small>CSGLD-1608</small>	

DA FORM 2408-9, 1 OCT 1972 REPLACES DA FORMS 2408-7, 1 JAN 1964, AND 2408-8, 1 JAN 1964, WHICH ARE OBSOLETE USAPA V1.00  
NMP COPY 1 CONTROL COPY 2 LOG BOOK COPY 3

Legend for Figure 5-7;

completion instructions follow.

CONTROL NO. Contains a six-character control number. HARD COPY USE ONLY—automated systems are now available and operational, so this field is no longer needed unless it is used to replace a missing serial number.

1. ORGANIZATION. Enter the name of the activity or organization accepting the item into the Army inventory.
2. LOCATION. Enter the location and zip code of the activity in block 1.
3. UNIT IDENT CODE. Enter the UIC of the activity in block 1 (cannot be blank). Do not use the six-position DODAAC.
4. UTILIZATION CODE.
  - a. Enter the code from table B-6 that applies to the reporting unit and equipment.
  - b. Contains code V for passenger-carrying and general-purpose vehicles (formerly called admin-use vehicles).
5. VEHICLE USE CODE.

Figure 5-7. Sample DA Form 2408-9 used for acceptance and registration

- a. For all nontactical wheeled vehicles, as listed in figure E-4, enter the code that applies to the equipment's use in this block: A—Army operated, includes any Army-owned passenger carrying and general purpose vehicles listed in figure E-4, used or operated by Army personnel (Government owned, Government operated, or GOGO); B—Contractor operated, includes any Army-owned passenger carrying and general-purpose vehicles listed in figure E-4, that are furnished to contractors by the Department of the Army for contractor use (Government owned, contractor operated, or GOCO); R—Facilities engineering vehicles, includes special purpose (commercial) and military design vehicles used by installation real property management activities; X—All other special purpose vehicles, includes all other special purpose vehicles not covered by code R.
- b. Leave blank for other equipment.
6. NOMENCLATURE. Enter the noun of the equipment.
7. MODEL. For OTHER than passenger carrying and general-purpose vehicle, enter the model of the item. For passenger-carrying and general purpose vehicles, this block contains the LIN for the item as listed in figure E-4, or the FED LOG. For watercraft, enter the hull design number.
8. NATIONAL STOCK NO. Contains the NSN of the item.
9. SERIAL NO.
- a. Enter the complete serial number of the item. Make sure to list ALL characters and numbers making up the serial number and to include any preprinted suffix or prefix.
- b. For equipment with no serial number, use the preprinted control number on the form. The control number becomes the permanent serial number for the equipment on all forms and records.
- c. For watercraft, enter the hull number.
- d. For vehicle mounted weapon systems, like the M113A2 TOW, and so on. Use the vehicle's serial number.
10. REGISTRATION NO.
- a. Enter the registration number assigned to the item. Do not use the alpha character "O" or "I"—always use 0 (zero) or 1 (one).
- b. If the equipment is not under the Army Vehicle Registration Program, leave blank. If a registration number is needed, contact LOGSA.
- c. For watercraft, enter the registration number if one has been assigned. If not, use the hull number.
11. YEAR OF MFG. Enter the four-digit model year, for example, 2004.
- a. For OTHER than passenger carrying and general-purpose vehicles, enter the two-digit year the equipment was manufactured. Enter the letter M before the two numbers. For example, for an item manufactured in 1990, enter M90.
- b. For nontactical passenger carrying and general-purpose vehicles, enter the four-digit model year (1998, 1999, and so).
12. MANUFACTURER (*MFG Code*). Enter the name and five-digit code for the manufacturer here. Manufacturers codes are found in SB 708-43.
13. CONTRACT NO. Enter the contract number under which the item was bought. For passenger carrying and general-purpose vehicles, this block contains the procurement contract number, for example, DAAE07-71KK-C-005 or GS-00S-05892.
14. PURCHASE ORDER NO. Leave blank.
15. WARRANTY PERIOD. Enter the warranty period as stated in the contract.
16. TYPE REPORT. Leave blank.
17. REPORT CODE. On line a, enter the code for the source of the item in the corresponding box: A—For equipment accepted from the manufacturer, B—For items accepted from local procurement.
18. USAGE. Leave blank.
19. SHIPPED TO.
- a. ORGANIZATION. Leave blank.
- b. SHIPPED TO UIC. Leave blank.
20. RECEIVED FROM.
- a. ORGANIZATION. Leave blank.
- b. RECEIVED FROM UIC. Leave blank.
21. REMARKS.
- a. Print "Permanent Logbook Copy" here.
- b. For vehicles with radio mounts, identify the installation kit. This information is needed to identify the equipment for local use and when the equipment is transferred.
22. INSPECTOR'S SIGNATURE. The person accepting the item into the Army inventory signs and enters his or her telephone number.
23. JULIAN DATE. Enter the four-digit Julian date of acceptance (for example, 4045).

**Figure 5-7. Sample DA Form 2408-9 used for acceptance and registration**

---

CONTROL NO. <b>D 03287</b>		1. ORGANIZATION 845th Signal Battalion		2. LOCATION Pascagoula, MS 39563		3. UNIT IDENT CODE WSVMAA		4. UTILIZATION CODE A		5. VEHICLE USE CODE	
6. NOMENCLATURE TRUCK, UTL, TAC, 3/4 T			7. MODEL M1009		8. NATIONAL STOCK NO. 2320-01-123-2665			9. SERIAL NO. 1G8ED18JXFF120336		10. REGISTRATION NO. NF08W5	
11. YEAR OF MFG M84		12. MANUFACTURER (MFG Code)			13. CONTRACT NO.		14. PURCHASE ORDER NO.		15. WARRANTY PERIOD		
16. TYPE REPORT			17. REPORT CODE		18. USAGE		19. SHIPPED TO a. ORGANIZATION		b. SHIPPED TO UIC		
a. ACCEPTANCE AND REGISTRATION					a. HOURS						
b. USAGE			C								
c. TRANSFER					b. MILES						
d. LOSS					M64,964						
e. GAIN					c. ROUNDS		20. RECEIVED FROM a. ORGANIZATION		b. RECEIVED FROM UIC		
f. OTHER											
21. REMARKS					DON'T FORGET THE "M" FOR MILES OR THE "K" FOR KILOMETERS WHEN YOU ENTER THE USAGE						
22. INSPECTOR'S SIGNATURE <i>John W. Smith</i>								23. JULIAN DATE 5309			
EQUIPMENT CONTROL RECORD For use of this form, see DA PAM 750-8; the proponent agency is DCS, G4								REPORTS CONTROL SYMBOL CSGLD-1608			

DA FORM 2408-9  
1 OCT 72

REPLACES DA FORMS 2408-7, 1 JAN 64, AND 2408-8, 1 JAN 64, WHICH ARE OBSOLETE.

NMP COPY 1

Notes:

- 1 All units with ULLS-G report monthly using the AMSS automated process.
- 2 The maintenance officer is responsible for completing and distributing Usage Reports as of these dates: As of 1 Oct for nontactical vehicles; as of 1 Nov for tactical vehicles; as of 1 Feb and 1 Aug for watercraft.

Legend for Figure 5-8;  
completion instructions follow.

CONTROL NUMBER. Contains a six-character control number. HARD COPY USE ONLY—automated systems are now available and operational, so this field is no longer needed unless it is used to replace a missing serial number.

1. ORGANIZATION. Enter the name of the reporting unit (parent unit).
2. LOCATION. Enter the location and zip code or Army post office (APO) of the activity in block 1.
3. UNIT IDENT CODE. Enter the UIC of the activity in block 1. Must not be blank. Do not use the six-position DODAAC.
4. UTILIZATION CODE.
  - a. Enter the code from table B-6 that applies to the reporting unit and equipment.
  - b. Contains code V for passenger-carrying and general-purpose vehicles (formerly called admin-use vehicles).
5. VEHICLE USE CODE.
  - a. For all nontactical wheeled vehicles, as listed in figure E-4, enter the code that applies to the equipments use in this block: A—Army operated, includes any Army-owned passenger carrying and general purpose vehicles listed in figure E-4, used or operated by the Army personnel (GOGO); B—Contractor operated, includes any Army-owned passenger carrying and general purpose vehicles listed in figure E-4, that are furnished to contractors by the Department of the Army for contractor use (GOCO); R—Facilities engineering vehicles, includes special purpose (commercial) and military design vehicles used by installation real property management activities; X—All other special purpose vehicles, includes all other special purpose vehicles not covered by code R.
  - b. Leave blank for other equipment.
6. NOMENCLATURE. Enter the noun of the equipment.
7. MODEL.
  - a. For OTHER than passenger carrying and general-purpose vehicles enter the model of the equipment.
  - b. For passenger-carrying and general purpose vehicles, this block contains the LIN for the item as it is listed in figure E-4, or the FED LOG.
8. NATIONAL STOCK NO. Contains the NSN of the item.
9. SERIAL NO.
  - a. Enter the complete serial number of the item. Make sure ALL characters and numbers making up the serial number are listed, to include any preprinted suffix or prefix.
  - b. For equipment with no serial number, use the preprinted control number on the Acceptance or Gain Report (DA Form 2408-9).
  - c. For watercraft, enter the hull number.

Figure 5-8. Sample DA Form 2408-9 used to record usage

10. REGISTRATION NO.
- a. Enter the registration number assigned to the equipment. Do not use the alpha character of "O" or "I"—always use 0 (zero) or 1 (one).
  - b. For watercraft, enter the registration number if one has been assigned. If no registration number has been assigned, and one is required, contact LOGSA.
11. YEAR OF MFG. Enter the four-digit model year, for example, 2004.
- a. For usage reports on passenger-carrying and general-purpose vehicles, enter the four-digit model year, for example: 1990 or 1993.
  - b. For all other equipment, enter a three-character position entry. This entry contains the two-digit year that the equipment was manufactured. Enter the letter M before the numbers. For an item manufactured in 1990, enter M90 in this block.
12. MANUFACTURER (*MFG Code*). Leave blank.
13. CONTRACT NO. Leave blank.
14. PURCHASE ORDER NO. Leave blank.
15. WARRANTY PERIOD. Leave blank.
16. TYPE REPORT. Leave report.
17. REPORT CODE.
- a. For a periodic usage report, enter the letter C on line *b*.
  - b. For a special DA-directed usage report, enter the letter D on line *b*.
18. USAGE.
- a. Enter the total kilometers or miles in block 18*b* only, as applies to the equipment. Enter the letter M before the number for miles. Enter the letter K before the number for kilometers. Make sure this block shows the total use over the lifetime of the equipment, up to and including the day the form is completed. Add the current meter reading to the total usage from previous meters. DD Form 314 provides total usage at the time the current meter was installed.
  - b. For equipment with no meter or an inoperative meter, enter the estimated miles in block 18*b*.
  - c. For overhauled equipment, enter the total usage in block 18*b* since overhauled.
19. SHIPPED TO.
- a. ORGANIZATION. Leave blank.
  - b. SHIPPED TO UIC.
20. RECEIVED FROM. Leave blank.
- a. ORGANIZATION. Leave blank.
  - b. RECEIVED FROM UIC. Leave blank.
21. REMARKS. For usage reports on watercraft, enter usage data on all engines in this block: serial number, identifying application of the engine, location and usage since the last report went in. For example: Ser No. ID/APP Location Usage 671RC3567 - Main Engine - Port-Engine Room - 525 Hrs 671RC3568 - Main Engine - Starboard - Engine Room - 525 Hrs 678253 - Emergency Generator Engine - Emergency Generator Room - 10 Hrs 85C3A1 - Generator - Port - Engine Room - 1500 Hrs 85C3A2 - Generator - Starboard - Engine Room - 1650 Hrs.
22. INSPECTOR'S SIGNATURE. The person completing the form signs and enters his or her telephone number.
23. JULIAN DATE. Enter the four-digit Julian date of the appropriate reporting date: 1 Feb (4032), 1 Aug (4213), 1 Oct (4274), or 1 Nov (4305).

**Figure 5–8. Sample DA Form 2408–9 used to record usage**

---

CONTROL NO. <b>J865111</b>		1. ORGANIZATION ECS #103(G)		2. LOCATION Franklin, PA 16323		3. UNIT IDENT CODE W3EH55		4. UTILIZATION CODE A		5. VEHICLE USE CODE	
6. NOMENCLATURE TRK UT TAC			7. MODEL M1009		8. NATIONAL STOCK NO. 2320-01-123-2665			9. SERIAL NO. 1G8ED18JXGF116627		10. REGISTRATION NO NFOFS8	
11. YEAR OF MFG		12. MANUFACTURER (MFG Code)		13. CONTRACT NO.		14. PURCHASE ORDER NO.					
18. TYPE REPORT			17. REPORT CODE		18. USAGE		19. SHIPPED TO a. ORGANIZATION			b. SHIPPED TO UIC	
a. ACCEPTANCE AND REGISTRATION					a. HOURS		20. RECEIVED FROM a. ORGANIZATION 321 OD BN Charleston, WV 25313			b. RECEIVED FROM UIC WQ05AA	
b. USAGE					b. MILES						
c. TRANSFER			2								
d. LOSS											
e. GAIN					c. ROUNDS						
f. OTHER											
21. REMARKS											
22. INSPECTOR'S SIGNATURE <i>Jorge Huertas (445) 662-4411</i>								23. JULIAN DATE 6206			
<b>EQUIPMENT CONTROL RECORD</b> <small>For use of this form, see DA PAM 750-8; the proponent agency is DCS, G4</small>								<small>REPORTS CONTROL SYMBOL CSGLD-1608</small>			

DA FORM 2408-9  
1 OCT 72

REPLACES DA FORMS 2408-7, 1 JAN 64, AND 2408-8, 1 JAN 64, WHICH ARE OBSOLETE.

NMP COPY 1

Legend for Figure 5-9;

completion instructions follow.

CONTROL NO. Contains a six-character control number. HARD COPY USE ONLY—automated systems are now available and operational, so this field is no longer needed unless it is used to replace a missing serial number.

1. ORGANIZATION. Enter the name of the reporting unit.
2. LOCATION. Enter the location and zip code of the activity in block 1.
3. UNIT IDENT CODE. Enter the UIC of the activity in block 1. Must not be blank. Do not use the six-position DODAAC.
4. UTILIZATION CODE.
  - a. Enter the code from table B-6 that applies to the reporting unit and equipment.
  - b. Enter code V for passenger-carrying and general-purpose vehicles (formerly called admin-use vehicles).
5. VEHICLE USE CODE.
  - a. For all nontactical wheeled vehicles, as listed in figure E-4, enter the code that applies to the equipments use in this block: A—Army operated, includes any Army-owned passenger carrying and general purpose vehicles listed in figure E-4, used or operated by Army personnel (GOGO); B—Contractor operator, includes any Army-owned passenger carrying and general-purpose vehicles listed in figure E-4 that are furnished to contractors by the Department of the Army for contractor use (GOCO); R—Facilities engineering vehicles, includes special purpose (commercial) and military design vehicles used by installation real property management activities; X—All other special purpose vehicles, includes all other special purpose vehicles not covered by code R.
  - b. Leave blank for other equipment.
6. NOMENCLATURE. Enter the noun of the equipment.
7. MODEL.
  - a. Enter the model of the item.
  - b. For passenger-carrying and general purpose vehicles, this block contains the LIN for the item as it is listed in figure E-4, or the FED LOG.
  - c. For watercraft, enter the hull design number.
8. NATIONAL STOCK NO. Contains the NSN in this block.
9. SERIAL NO.
  - a. Enter the complete serial number of the item. Make sure ALL characters and numbers that make up the serial number are listed, to include any preprinted suffix or prefix.
  - b. If the item has no serial number, use the control number of the Acceptance or Gain Report (DA Form 2408-9).
  - c. For vehicle mounted weapon systems, for example, the M113A2 TOW, use the vehicle serial number.
10. REGISTRATION NO.
  - a. Enter the registration number of the equipment. Do not use the alpha character of "O" or "I"—always use 0 (zero) or 1 (one).
  - b. If no registration number has been assigned, leave the block blank.

Figure 5-9. Sample DA Form 2408-9 used to record transfer

- c. For watercraft, enter the registration number, if one has been assigned. If it has no registration number, use the hull number.
11. YEAR OF MFG. Enter the four-digit model year, for example, 2004..
12. MANUFACTURER (*MFG Code*). Leave blank.
13. CONTRACT NO. Leave blank.
14. PURCHASE ORDER NO. Leave blank.
15. WARRANTY PERIOD. Leave blank.
16. TYPE REPORT. Leave blank.
17. REPORT CODE. Enter the applicable report code on line c. Report codes are:
- a. to another property account.
  - b. from another property account.
18. USAGE. Leave blank.
19. SHIPPED TO.
- a. ORGANIZATION. If report code 1 is in block 17c, enter the name and location of the organization to which the item is being sent.
  - b. SHIPPED TO UIC. If a report code 1 is in block 17c, enter the UIC of the organization to which the item is being sent. When a report code (1 ) appears in block 17c, there will be a UIC (not a DODAAC) in block 19b.
20. RECEIVED FROM.
- a. ORGANIZATION. If report code 2 is in block 17c, enter the name and location of the organization from which the item is being sent.
  - b. RECEIVED FROM UIC. If a report code 2 is in block 17c, enter the UIC of the organization to which the item is being sent.
21. REMARKS. Leave blank.
22. INSPECTOR'S SIGNATURE. The person completing the form signs and enters his or her telephone number.
23. JULIAN DATE. Enter the four-digit Julian date of the report, for example, 4045.

**Figure 5-9. Sample DA Form 2408-9 used to record transfer**

---

CONTROL NO. <b>L 053783</b>		1. ORGANIZATION Anniston Army Depot		2. LOCATION Anniston, AL 36201		3. UNIT IDENT CODE W0LXAA		4. UTILIZATION CODE 1		5. VEHICLE USE CODE	
6. NOMENCLATURE Tank, Combat FT 105mm			7. MODEL M60A1		8. NATIONAL STOCK NO. 2350-00-756-8497		9. SERIAL NO. 6713		10. REGISTRATION NO. JJ0078		
11. YEAR OF MFG		12. MANUFACTURER (MFG Code)		13. CONTRACT NO.		14. PURCHASE ORDER NO.		15. WARRANTY PERIOD			
16. TYPE REPORT			17. REPORT CODE		18. USAGE		19. SHIPPED TO g. ORGANIZATION		20. SHIPPED TO UIC		
d. ACCEPTANCE AND REGISTRATION					a. HOURS						
b. USAGE											
c. TRANSFER					b. MILES						
d. LOSS			K				20. RECEIVED FROM g. ORGANIZATION		21. RECEIVED FROM UIC		
e. GAIN					c. ROUNDS						
f. OTHER											
21. REMARKS											
22. INSPECTOR'S SIGNATURE <i>Richard Oker</i> (256) 444-6289								23. JULIAN DATE 7050			
<b>EQUIPMENT CONTROL RECORD</b> For use of this form, see DA PAM 750-8; the proponent agency is DCS, G4								REPORTS CONTROL SYMBOL CSGLD-1608			
DA FORM 1 OCT 72 2408-9		REPLACES DA FORMS 2408-7, 1 JAN 64, AND 2408-8, 1 JAN 64, WHICH ARE OBSOLETE.						NMP COPY 1			

Legend for Figure 5-10;  
completion instructions follow.

CONTROL NO. Contains a six-character control number. HARD COPY USE ONLY—automated systems are now available and operational, so this field is no longer needed unless it is used to replace a missing serial number.

1. ORGANIZATION. Enter the name of the reporting unit.
2. LOCATION. Enter the location and zip code of the activity in block 1.
3. UNIT IDENT CODE. Enter the UIC of the activity in block 1. Must not be blank. Do not use the six-position DODAAC.
4. UTILIZATION CODE.
  - a. Enter the code from table B-6 that applies to the reporting unit and equipment.
  - b. Enter code V for passenger-carrying and general-purpose vehicles (formerly called admin-use vehicles).
5. VEHICLE USE CODE.
  - a. For all nontactical wheeled vehicles, as listed in figure E-4, enter the code that applies to the equipment's use in this block: A—Army operated, includes any Army-owned passenger carrying and general purpose vehicles listed in figure E-4, used or operated by Army personnel (GOGO); B—Contractor operator, includes any Army-owned passenger carrying and general-purpose vehicles listed in figure E-4, that are furnished to contractors by the Department of the Army for contractor use (GOCO); R—Facilities engineering vehicle, includes special purpose (commercial) and military design vehicles used by installation real property management activities; X—All other special purpose vehicles, includes all other special purpose vehicles not covered by code R.
  - b. Leave blank for other equipment.
6. NOMENCLATURE. Enter the noun of the equipment.
7. MODEL.
  - a. Enter the model of the item.
  - b. For passenger-carrying and general purpose vehicles, this block contains the LIN for the item as it is listed in figure E-4, or the FED LOG.
  - c. For watercraft, enter the hull design number.
8. NATIONAL STOCK NO. Enter the NSN in this block.
9. SERIAL NO.
  - a. Enter the complete serial number of the item. Make sure ALL characters and numbers that make up the serial number are entered, to include any preprinted suffix or prefix.
  - b. If the item has no serial number, use the control number of the Acceptance or Gain Report (DA Form 2408-9).
  - c. For vehicle mounted weapon systems, for example, the M113A2 TOW, use the vehicle serial number.
10. REGISTRATION NO.
  - a. Enter the registration number of the equipment. Do not use the alpha character of "O" or "I"—always use 0 (zero) or 1 (one).
  - b. If no registration number has been assigned, leave the block blank. If a registration number is required, contact LOGSA.
  - c. For watercraft, enter the registration number, if one has been assigned. If it has no registration number, use the hull number.
11. YEAR OF MFG. Enter the four-digit model year, for example, 2004.
12. MANUFACTURER (MFG Code). Enter the name and five-digit code for the manufacturer here. Manufacturer's codes are in equipment manual SB 708-43.

Figure 5-10. Sample DA Form 2408-9 used to record loss



13. CONTRACT NO. Enter the contract number under which the item was bought. For passenger-carrying and general-purpose vehicles, this block will contain the procurement contract number, for example, DAAE07-71KK-C-005 or GS-00S-05892.
14. PURCHASE ORDER NO. Leave blank.
15. WARRANTY PERIOD. Leave blank.
16. TYPE REPORT. Leave blank.
17. REPORT CODE. Enter the applicable loss code on line *d*. Loss codes are: E—loss due to disassembly of a reportable integrated set/assembly; I—combat loss (abandoned, captured, destroyed); J—turned into DRMO or cannibalization point; K—shipped to other (non-Army) Government departments, agencies, services, MAP, Foreign Military Sales; L—physical loss other than combat (pilferage, theft, and so on.); N—identification loss, integrated into a set assembly or system; or change of equipment serial number or registration number; Z—Reconciliation.
18. USAGE. Leave blank.
19. SHIPPED TO.
- a. ORGANIZATION. Leave blank.
- b. SHIPPED TO UIC. Leave blank.
20. RECEIVED FROM.
- b. SHIPPED TO UIC. Leave blank
- a. ORGANIZATION. Leave blank.
21. REMARKS. Leave blank.
22. INSPECTOR'S SIGNATURE. The person completing the form signs and enters his or her telephone number.
23. JULIAN DATE. Enter the four-digit Julian date the report was completed, for example, 4045.

Figure 5-10. Sample DA Form 2408-9 used to record loss

CONTROL NO. <b>L 053758</b>	1. ORGANIZATION 142d ENGR CBT BN	2. LOCATION FARGO, ND 58102	3. UNIT IDENT CODE WV44AA	4. UTILIZATION CODE 7	5. VEHICLE USE CODE
6. NOMENCLATURE TRK DMP WW	7. MODEL M930A2 WW	8. NATIONAL STOCK NO. 2320-01-230-0306	9. SERIAL NO. 0125-28014	10. REGISTRATION NO 4J3807	
11. YEAR OF MFG M84	12. MANUFACTURER (MFG Order)	13. CONTRACT NO.	14. PURCHASE ORDER NO.		15. WARRANTY PERIOD
16. TYPE REPORT	17. REPORT CODE	18. USAGE	19. SHIPPED TO a. ORGANIZATION		b. SHIPPED TO UIC
a. ACCEPTANCE AND REGISTRATION		a. HOURS			
b. USAGE		b. MILES			
c. TRANSFER			20. RECEIVED FROM a. ORGANIZATION		b. RECEIVED FROM UIC
d. LOSS					
e. GAIN	Q	c. ROUNDS			
f. OTHER					
21. REMARKS Vehicle obtained from DRMO "PERMANENT LOGBOOK COPY"					
22. INSPECTOR'S SIGNATURE <i>Joseph Jones</i> EQUIPMENT CONTROL RECORD For use of this form, see DA PAM 750-8; the proponent agency is DCS, G4			23. JULIAN DATE 0892 REPORTS CONTROL SYMBOL CSGLD-1608		

DA FORM 2408-9, 1 OCT 1972 REPLACES DA FORMS 2408-7, 1 JAN 1964, AND 2408-8, 1 JAN 1964, WHICH ARE OBSOLETE USAPA V1.00  
NMP COPY 1 CONTROL COPY 2 LOG BOOK COPY 3

Legend for Figure 5-11;

completion instructions follow.

CONTROL NO. Contains a six-character control number. HARD COPY USE ONLY—automated systems are now available and operational, so this field is no longer needed unless it is used to replace a missing serial number.

1. ORGANIZATION. Enter the name of the reporting unit.
2. LOCATION. Enter the location and zip code of the activity in block 1.
3. UNIT IDENT CODE. Enter the UIC of the activity in block 1. Must not be blank. Do not use the six-position DODAAC.
4. UTILIZATION CODE.
  - a. Enter the code from table B-6 that applies to the reporting unit and equipment.
  - b. Enter code V for passenger-carrying and general-purpose vehicles (formerly called admin-use vehicles).

Figure 5-11. Sample DA Form 2408-9 used to record gain

5. VEHICLE USE CODE.

a. For all nontactical wheeled vehicles, as listed in figure E-4, enter the code that applies to the equipment's use in this block: A—Army operated, includes any Army-owned passenger carrying and general purpose vehicles listed in figure E-4, used or operated by Army personnel (GOGO); B—Contractor operator, includes any Army-owned passenger carrying and general-purpose vehicles listed in figure E-4, that are furnished to contractors by the Department of the Army for contractor use (GOCO); R—Facilities engineering vehicles, includes special purpose (commercial) and military design vehicles used by installation real property management activities; X—All other special purpose vehicles, includes all other special purpose vehicles not covered by code R.

b. Leave blank for other equipment.

6. NOMENCLATURE. Enter the noun of the equipment.

7. MODEL.

a. Enter the model of the item.

b. For passenger-carrying and general-purpose vehicles, enter the LIN for the item as it is listed in figure E-4, or the FED LOG.

8. NATIONAL STOCK NO. Enter the NSN in this block.

9. SERIAL NO.

a. Enter the complete serial number of the item. Make sure ALL characters and numbers that make up the serial number are listed, to include any preprinted suffix or prefix.

b. If the item has no serial number, use the control number of the Acceptance or Gain Report (DA Form 2408-9).

c. For vehicle mounted weapon systems, for example, the M113A2 TOW, use the vehicle serial number.

10. REGISTRATION NO.

a. Enter the registration number of the equipment. Do not use the alpha character of "O" or "I"—always use 0 (zero) or 1 (one).

b. If no registration number has been assigned, leave the block blank.

c. For watercraft, enter the registration number, if one has been assigned. If it has no registration number, use the hull number.

11. YEAR OF MFG.

a. For Gain Reports on passenger-carrying and general-purpose vehicles, enter the four-digit model year; for example: 1992.

b. For Gain Reports on other than passenger-carrying and general-purpose vehicles, enter the two-digit year the equipment was manufactured. Enter the letter M before the numbers. For example, this block would contain M98 for an item manufactured in 1998 or later.

12. MANUFACTURER (*MFG Code*). If known, enter the name and five-digit code for the manufacturer here. Manufacturer's codes are in equipment manual SB 708-43.

13. CONTRACT NO. If known, enter the contract number under which the item was bought. For passenger-carrying and general-purpose vehicles, this block will contain the procurement contract number, for example, DAAE07-71KK-C-005 or GS-00S-05892.

14. PURCHASE ORDER NO. Leave blank.

15. WARRANTY PERIOD. Leave blank.

16. TYPE REPORT. Leave blank.

17. REPORT CODE. Enter the appropriate gain code on line e. Gain codes are: F—Gain of an item as a result of disassembly of an integrated set/assembly. P—Combat Gain (recaptured or recovered); Q—Reclaimed from Defense Reutilization and Marketing Office (DRMO) or cannibalization point; R—Received from other (non-Army) Government departments, agencies or services; T—Identification gain, integrated set assembly with new NSN; or a change of equipment serial number or registration; U—Inventory adjustment gain (found on post); this code is also used to report the gain of reportable items of equipment that have been added to appendix E by TWX or changes to this pamphlet and to report the gain of previously unknown or unreported assets.

18. USAGE. Leave blank.

19. SHIPPED TO.

a. ORGANIZATION. Leave blank.

b. SHIPPED TO UIC. Leave blank.

20. RECEIVED FROM.

a. ORGANIZATION. Leave blank.

b. SHIPPED TO UIC. Leave blank.

21. REMARKS. Enter the words, "Permanent Logbook Copy," in this space. Also enter the name of the organization from whom the item was obtained.

22. INSPECTOR'S SIGNATURE. The person completing the form signs and enters his or her telephone number.

23. JULIAN DATE. Enter the four-digit Julian date the report was made out, for example, 4045.

**Figure 5-11. Sample DA Form 2408-9 used to record gain**

---

CONTROL NO. <b>L 053755</b>		1. ORGANIZATION HHC 1/263 Amor		2. LOCATION Mullins, SC 29574		3. UNIT IDENT CODE W746T0		4. UTILIZATION CODE 7		5. VEHICLE USE CODE	
6. NOMENCLATURE Recovery Vehicle			7. MODEL M88A1		8. NATIONAL STOCK NO. 2350-00-122-6826		9. SERIAL NO. 1613		10. REGISTRATION NO JT0000		
11. YEAR OF MFG M82		12. MANUFACTURER (MFG Code)		13. CONTRACT NO.		14. PURCHASE ORDER NO.		15. WARRANTY PERIOD			
16. TYPE REPORT				17. ORGANIZATION PERFORMING THE REPAIR ACTION		18. SHIPPED TO		19. SHIPPED TO UIC			
a. ACCEPTANCE AND REGISTRATION				b. HOURS		c. ORGANIZATION		d. RECEIVED FROM			
b. USAGE				c. MILES		e. ORGANIZATION		d. RECEIVED FROM UIC			
c. TRANSFER				M4173		f. ORGANIZATION		e. RECEIVED FROM UIC			
d. LOSS				c. ROUNDS		g. ORGANIZATION		f. RECEIVED FROM UIC			
e. GAIN				W		h. ORGANIZATION		g. RECEIVED FROM UIC			
f. OTHER						i. ORGANIZATION		h. RECEIVED FROM UIC			
21. REMARKS CORUS Tactical Wheeled Vehicle Repair											
22. INSPECTOR'S SIGNATURE											
23. JULIAN DATE 0193											
<b>EQUIPMENT CONTROL RECORD</b> For use of this form, see DA PAM 750-8; the proponent agency is DCS, G4											
REPORTS CONTROL SYMBOL CSGLD - 1608											

DA FORM 2408-9  
OCT 72

REPLACES DA FORMS 2408-7, 1 JAN 64, AND 2408-8, 1 JAN 64, WHICH ARE OBSOLETE.

NMP COPY 1

Legend for Figure 5-12;

completion instructions follow.

CONTROL NO. Contains a six-character control number. HARD COPY USE ONLY—automated systems are now available and operational, so this field is no longer needed unless it is used to replace a missing serial number.

1. ORGANIZATION. Enter the name of the organization performing the repair.

2. LOCATION. Enter the location and zip code or APO of the activity in block 1.

3. UNIT IDENT CODE. Enter the UIC of the activity in block 1. Must not be blank. Do not use the six-position DODAAC.

4. UTILIZATION CODE. Enter the code from table B-6 that applies to the reporting unit and equipment. Will contain code V for passenger-carrying and general-purpose vehicles (formerly called Admin-use vehicles).

5. VEHICLE USE CODE. For all nontactical wheeled vehicles, as listed in appendix E, table E-4, enter the code that applies to the equipment's use in this block: A—Army operated, which includes any Army-owned passenger carrying and general purpose vehicles listed in appendix E, table E-4, used or operated by Army personnel (GOGO); B—Contractor operated, which includes any Army-owned passenger carrying and general-purpose vehicles listed in appendix E, table E-4, that are furnished to contractors by the Department of the Army for contractor use (GOCO); R—Facilities engineering vehicles, which includes special purpose (commercial) and military design vehicles used by installation real property management activities; X—All other special purpose vehicles, which Includes all other special purpose vehicles not covered by code R. Leave blank for other equipment.

6. NOMENCLATURE. Enter the noun description of the equipment.

7. MODEL. Enter the model of the equipment.

8. NATIONAL STOCK NUMBER. Enter the NSN of the item.

9. SERIAL NUMBER.

a. Enter the complete serial number of the item. Make sure ALL the letters and numbers making up the serial number are listed, to include any preprinted suffix and prefix.

b. If the item has no serial number, use the control number on the Acceptance or Gain report (DA Form 2408-9).

10. REGISTRATION NUMBER. Enter the registration number assigned to the equipment. Do not use the alpha character of "O" or "I"—always use 0 (zero) or 1 (one). If no registration number has been assigned, and one is required, contact LOGSA. Otherwise, leave this block blank.

11. YEAR OF MFG. Enter a three-character alpha/numeric entry. This entry consists of the two-digit year equipment was manufactured. Enter the letter M before the numbers. For an item manufactured in 1990, enter M90 in block 11.

12. MANUFACTURER (MFG Code). Leave blank.

13. CONTRACT NO. Leave blank.

14. PURCHASE ORDER NO. Leave blank.

15. WARRANTY PERIOD. Leave blank.

16. TYPE REPORT.

Figure 5-12. Sample DA Form 2408-9 used to record repair

17. REPORT CODE. Enter the code *W* in block 17*f* to indicate repair.
18. USAGE.
- a. Enter the total miles or kilometers only, as applies to the equipment. Enter the letter *M* before the number for miles. Enter the letter *K* before the number of kilometers. Make sure this block shows the total use over the lifetime of the equipment, up to and including the day the form is completed. Add the current meter reading to the total usage from previous meters. DD Form 314 provides total usage at the time the current meter was installed.
- b. For overhauled equipment, enter the total usage since overhaul. For equipment with no odometer, enter 0 in this block.
19. SHIPPED TO.
- a. ORGANIZATION. Leave blank.
- b. SHIPPED TO UIC. Leave blank.
20. RECEIVED FROM.
- a. ORGANIZATION. Leave blank.
- b. SHIPPED TO UIC. Leave blank.
21. REMARKS. Enter the type of Comprehensive Class VII repair program, that is, Recapitalization Program, CONUS tactical wheeled vehicle repair, or General Support Repair Program.
22. INSPECTOR'S SIGNATURE.
23. JULIAN DATE. Enter the four-digit Julian date the repair action was completed, for example, 4049.

Figure 5-12. Sample DA Form 2408-9 used to record repair

CONTROL NO. L 053754		1. ORGANIZATION RED RIVER ARMY DEPOT		2. LOCATION TEXARKANA, TX 75507		3. UNIT IDENT CODE WOMCAA		4. UTILIZATION CODE I		5. VEHICLE USE CODE	
6. NOMENCLATURE CARRIER, PERSONNEL			7. MODEL M113A2		8. NATIONAL STOCK NO. 2350-01-068-4077		9. SERIAL NO. SJ10135MAA		10. REGISTRATION NO. 12C12369		
11. YEAR OF MFG 1H99		12. MANUFACTURER (MFG Code)			13. CONTRACT NO.		14. PURCHASE ORDER NO.		15. WARRANTY PERIOD		
16. TYPE REPORT			17. REPORT CODE		18. USAGE		19. SHIPPED TO a. ORGANIZATION		b. SHIPPED TO UIC		
a. ACCEPTANCE AND REGISTRATION					a. HOURS				IF THE OVERHAUL ALSO RESULTS IN AN NSN CHANGE, THE OVERHAUL MUST BE REFLECTED AGAINST THE OLD NSN AND NOT THE NEW ONE		
b. USAGE					b. MILES						
c. TRANSFER					M2576		20. RECEIVED FROM a. ORGANIZATION		b. RECEIVED FROM UIC		
d. LOSS					c. ROUNDS				IF THE ODOMETER IS NOT RESET TO "0" MILES/KILOMETER (K OR M), AT THE TIME OF OVERHAUL, THE ODOMETER READING WILL BE RECORDED IN BLOCK 21 OF THE LOGBOOK COPY OF THE ACCEPTANCE OR GAIN REPORT		
e. GAIN					V						
f. OTHER											
21. REMARKS OVERHAULED ON 6-98, RED RIVER ARMY DEPOT											
22. INSPECTOR'S SIGNATURE <i>Anita Smith (903)413-8161</i>											
23. JULIAN DATE 8166											

**EQUIPMENT CONTROL RECORD**  
For use of this form, see DA PAM 750-8; the proponent agency is DCS, G4

REPORTS CONTROL SYMBOL  
CSGLD-1608

DA FORM 2408-9, 1 OCT 1972 REPLACES DA FORMS 2408-7, 1 JAN 1964, AND 2408-8, 1 JAN 1964, WHICH ARE OBSOLETE USAPA V1.00

NMP COPY 1 CONTROL COPY 2 LOG BOOK COPY 3

Legend for Figure 5-13;

completion instructions follow.

CONTROL NO. Contains a six-character control number. HARD COPY USE ONLY—automated systems are now available and operational, so this field is no longer needed unless it is used to replace a missing serial number.

1. ORGANIZATION. Enter the name of the activity performing the overhaul.
2. LOCATION. Enter the location and zip code or APO of the activity in block 1.
3. UNIT IDENT CODE. Enter the UIC of the activity in block 1. Must not be blank. Do not use the six-position DODAAC.
4. UTILIZATION CODE. Enter the code from table B-6 that applies to the reporting unit and equipment.
5. VEHICLE USE CODE. Leave blank.
6. NOMENCLATURE. Enter the noun of the equipment.
7. MODEL. Enter the model of the equipment.
8. NATIONAL STOCK NO. Enter the NSN in this block.
9. SERIAL NO.

Figure 5-13. Sample DA Form 2408-9 used to record overhaul

- a. Enter the complete serial number of the item. Make sure ALL characters and numbers making up the serial number are listed, to include any preprinted suffix or prefix.
- b. If the item has no serial number, use the control number on the Acceptance or Gain report (DA Form 2408-9).  
For watercraft, enter the hull number.
10. REGISTRATION NO.
- a. Enter the registration number assigned to the equipment. Do not use the alpha character of "O" or "I"—always use 0 (zero) or 1 (one). If no registration number has been assigned, and one is required, contact LOGSA. Otherwise, leave this block blank. If no registration number has been assigned and one is needed, contact LOGSA.
- b. For watercraft, enter the registration number if one has been assigned. If no registration number has been assigned, use the hull number.
11. YEAR OF MFG. Enter a four-digit alpha/numeric entry. Enter the number of this overhaul action in this block. Enter the letter H for overhaul and the two-digit year of the action after the number. For an item whose first overhaul is in 2003, enter 1H03. If the first overhaul was in 2003 and this overhaul is in 2004, enter 2H04.
12. MANUFACTURER (*MFG Code*). If known, enter the name and five-digit code for the manufacturer. Manufacturer's codes are in equipment manual SB 708-43.
13. CONTRACT NO. If known, enter the contract number under which the item was bought. For passenger-carrying and general-purpose vehicles, this block will contain the procurement contract number, for example, DAAE07-71KK-C-005 or GS-00S-05892.
14. PURCHASE ORDER NO. Leave blank.
15. WARRANTY PERIOD. Leave blank.
16. TYPE REPORT. Leave blank.
17. REPORT CODE. Enter the letter V on line f.
18. USAGE.
- a. Enter the cumulative usage reading on the equipment just prior to this overhaul action. Be sure to enter the K for kilometers or the M for Miles in front of the usage reading.
- b. If at the time of overhaul the odometer is NOT reset to zero miles/kilometers (K or M), the odometer reading is recorded in block 21 of the logbook copy of the acceptance or gain report.
19. SHIPPED TO.
- a. ORGANIZATION. Leave blank.
- b. SHIPPED TO UIC. Leave blank.
20. RECEIVED FROM.
- a. ORGANIZATION. Leave blank.
- b. SHIPPED TO UIC. Leave blank.
21. REMARKS. For equipment that is depot overhauled, the maintenance facility doing the action writes on the Permanent Logbook copy: "Overhauled on (month and year)" followed by the name of the facility.
22. INSPECTOR'S SIGNATURE. The person completing the form signs and enters his or her telephone number.
23. JULIAN DATE. Enter the four-digit Julian date of the report, for example, 4045.

**Figure 5-13. Sample DA Form 2408-9 used to record overhaul**

---

CONTROL NO. <b>L 053756</b>		1. ORGANIZATION BTRY A, 1/134th FA		2. LOCATION Marion, OH 43302		3. UNIT IDENT CODE WPNQAD		4. UTILIZATION CODE 7		5. VEHICLE USE CODE	
6. NOMENCLATURE HOWITZER MED S/P 155mm			7. MODEL M109A5		8. NATIONAL STOCK NO. 2350-01-281-1719			9. SERIAL NO. 2553		10. REGISTRATION NO 12D28068	
11. YEAR OF MFG 68		12. MANUFACTURER (MFG Code)		13. CONTRACT NO.		14. PURCHASE ORDER NO.			15. WARRANTY PERIOD		
16. TYPE REPORT		17. REPORT CODE		18. USAGE		19. SHIPPED TO a. ORGANIZATION			5. SHIPPED TO UIC		
a. ACCEPTANCE AND REPRODUCTION				4. HOURS		20. RECEIVED FROM a. ORGANIZATION			6. RECEIVED FROM UIC		
b. USAGE				8. MILES							
c. LOSS				c. ROUNDS							
e. GAIN		S									
f. OTHER											
21. REMARKS  THIS EQUIPMENT WAS REDESIGNATED FROM NSN 2350-01-277-5770, Model M109A4. (M)											
22. INSPECTOR'S SIGNATURE <i>Steven Jones</i> (740) 424-6611											
23. JULIAN DATE 6313											
<b>EQUIPMENT CONTROL RECORD</b> For use of this form, see DA PAM 750-8; the proponent agency is DCS, G4											
REPLACES DA FORMS 2408-7, 1 JAN 64, AND 2408-8, 1 JAN 64, WHICH ARE OBSOLETE											

DA FORM 2408-9  
OCT 72

REPORTS CONTROL SYMBOL  
CSGLD-1608

CONTROL COPY 2

Legend for Figure 5-14;

completion instructions follow.

CONTROL NO. Contains a six-character control number. HARD COPY USE ONLY—automated systems are now available and operational, so this field is no longer needed unless it is used to replace a missing serial number.

1. ORGANIZATION. Enter the name of the reporting unit.

2. LOCATION. Enter the location and zip code of the activity in block 1.

3. UNIT IDENT CODE. Enter the UIC of the activity in block 1. Must not be blank. Do not use the six-position DODAAC.

4. UTILIZATION CODE.

a. Enter the code from table B-6 that applies to the reporting unit and equipment.

b. Enter code V for passenger-carrying and general-purpose vehicles (formerly called admin-use vehicles).

5. VEHICLE USE CODE.

a. For all nontactical wheeled vehicles, as listed in figure E-4, enter the code that applies to the equipments use in this block: A—Army operated, includes any Army-owned passenger carrying and general purpose vehicles listed in figure E-4, used or operated by Army personnel (GOGO); B—Contractor operator, includes any Army-owned passenger carrying and general-purpose vehicles listed in figure E-4 that are furnished to contractors by the Department of the Army for contract use (GOCO); R—Facilities engineering vehicles, includes special purpose (commercial) and military design vehicles used by installation real property management activities; X—All other special purpose vehicles, includes all other special purpose vehicles not covered by code R.

b. Leave blank for other equipment.

6. NOMENCLATURE. Enter the noun of the equipment.

7. MODEL.

a. Enter the model of the item.

b. For passenger-carrying and general purpose vehicles, this block contains the LIN for the item as it is listed in figure E-4, or the FED LOG.

c. For watercraft, enter the hull design number.

8. NATIONAL STOCK NO. When maintenance action, MWO, and so on. changes the NSN of an item, the new NSN goes in this block. The old NSN is entered in block 21.

9. SERIAL NO.

a. Enter the complete serial number of the item. Make sure ALL characters and numbers that make up the serial number are listed, to include any preprinted suffix or prefix.

b. If the item has no serial number, use the control number of the Acceptance or Gain Report (DA Form 2408-9).

c. For vehicle mounted weapon systems, for example, the M113A2 TOW, use the vehicle serial number.

10. REGISTRATION NO.

a. Enter the registration number of the equipment. Do not use the alpha character of "O" or "I"—always use 0 (zero) or 1 (one).

Figure 5-14. Sample DA Form 2408-9 used to record NSN change

- b. If no registration number has been assigned, and one is required, contact LOGSA. Otherwise, leave this block blank.
- c. For watercraft, enter the registration number, if one has been assigned. If it has no registration number, use the hull number.
- 11. YEAR OF MFG. Enter the four-digit year the equipment was manufactured, for example, 2004. Make sure not to use a rebuild or overhaul date.
- 12. MANUFACTURER (*MFG Code*). Leave blank.
- 13. CONTRACT NO. Leave blank.
- 14. PURCHASE ORDER NO. Leave blank.
- 15. WARRANTY PERIOD. Leave blank.
- 16. TYPE REPORT. Leave blank.
- 17. REPORT CODE.
  - a. Enter report Code S on line e to report an identification gain, redesignated NSN. In block 21, enter the old NSN.
  - b. If a redesignation report results in a serial number or registration number change, a loss and gain report is required. Send in a Code N Loss for the old serial number/registration number and a Code T Gain for the new serial number/registration number (see figs 5–9 and 5–10).
- 18. USAGE. Leave blank.
- 19. SHIPPED TO.
  - a. ORGANIZATION. Leave blank.
  - b. SHIPPED TO UIC. Leave blank.
- 20. RECEIVED FROM.
  - a. ORGANIZATION. Leave blank.
  - b. SHIPPED TO UIC. Leave blank.
- 21. REMARKS. For an NSN Redesignation Report, when only the NSN has changed, enter the old NSN in this block. Immediately following the NSN, enter a CIRCLED M followed by the following statement: EQUIPMENT WAS REDESIGNATED FROM NSN 2350-00-485-9662, MODEL M109A2 (M). (This CIRCLED M is for data reduction instruction purposes). Enter Permanent Logbook Copy on the logbook copy.
- 22. INSPECTOR'S SIGNATURE. The person completing the form signs and enters his or her telephone number.
- 23. JULIAN DATE. Enter the four-digit Julian date of the report, for example, 4045.

**Figure 5–14. Sample DA Form 2408–9 used to record NSN change**

---

1. END ITEM		2. SAMPLE FREQUENCY		3. COMPONENT			
a. NOMENCLATURE TRK, CGO ST		100 HOURS 90 DAYS		a. NOMENCLATURE AND TYPE ENGINE NHC-25Ø			
b. MAKE OR TYPE T7923A1				b. SERIAL NUMBER 11102496		d. ACFT HRS LAST OIL CHANGE	
c. SERIAL NUMBER C523-Ø1815				c. TIME SINCE NEW OR OVERHAUL Ø		e. ACFT HRS INSTALLED	
4. DATE SAMPLE SUBMITTED	5. HOURS			6. REASON FOR SAMPLE	7. RESULTS	8. RESULTS RECEIVED	
	a. END ITEM	b. COMPONENT	c. LAST OIL CHANGE			a. DATE	b. PID
4 JAN 04	519	519	214	ROUTINE	NORMAL	10 JAN 04	D. Moorck
4 APR 04	565	565	260	ROUTINE	RESAMPLE	9 APR 04	W. Bunderk
9 APR 04	573	573	268	SPECIAL	CHG OIL, HIGH SILICON RESAMPLE AFTER 5 HRS	12 APR 04	W. Bunderk
12 APR 04	578	578	5	SPECIAL	NORMAL	16 APR 04	W. Bunderk
2 JUL 04	649	649	76	ROUTINE	NORMAL	5 JUL 04	W. Bunderk
19 SEP 04	749	749	176	ROUTINE	NORMAL	23 SEP 04	W. Bunderk
19 DEC 04	801	801	228	ROUTINE	NORMAL	23 DEC 04	W. Bunderk
19 MAR 05	890	890	317	ROUTINE	NORMAL	24 MAR 05	W. Bunderk

DA FORM 2408-20, OCT 97  
DA FORM 2408-20, DEC 91, MAY BE USED

**OIL ANALYSIS LOG**  
For use of this form, see DA PAM 750-8 and 738-751;  
the proponent agency is DCS, G4

APD V1.01

Figure 5-15. Sample DA Form 2408-20 (front)



4. DATE SAMPLE SUBMITTED	5. HOURS			6. REASON FOR SAMPLE	7. RESULTS	8. RESULTS RECEIVED	
	END ITEM <i>a</i>	COMPONENT <i>b</i>	LAST OIL CHANGE <i>c</i>			DATE <i>a</i>	PID <i>b</i>
9. REMARKS OIL CHANGED (OE/HBO 30) 12 APR 04 573 HOURS							

REVERSE OF DA FORM 2408-20, OCT 97

APD V1.01

Legend for Figure 5-15;  
completion instructions follow.

1. END ITEM.
  - a. NOMENCLATURE. Enter the noun of the end item.
  - b. MAKE OR TYPE. Enter the end item model number or type.
  - c. SERIAL NUMBER. Enter the end item serial number.
2. SAMPLE FREQUENCY. Enter the hours and date period by which samples are scheduled and taken.
3. COMPONENT.
  - a. NOMENCLATURE AND TYPE. Enter the component noun and type: for example, 6V53 engine or CD 850 transmission.
  - b. SERIAL NUMBER. Enter the component serial number.
  - c. TIME SINCE NEW OR OVERHAUL. Enter the number of hours that was on the component when it was installed. Underline the word NEW if the component was new; the word OVERHAUL if it has been overhauled. This number is carried forward to future DA Forms 2408-20 until the component is replaced or rebuilt.
4. DATE SAMPLE SUBMITTED. Enter the calendar date the sample was taken.
5. HOURS.
  - a. END ITEM. Enter total hours for the end item. Make sure any hours from replaced meters are added. See chapter 4 for help in converting miles to hours for those end items that have no hour meter, but do have an odometer. If the end item does not have an hour meter or odometer, enter the estimated hours.
  - b. COMPONENT. Enter the total hours on the component. If the component does not have an hour meter, use the end item odometer/odometer to determine this figure. Make sure any hours from replaced meters are added. See chapter 4 for help in converting miles of operation to hours of operation. If neither the component nor the end item has an odometer or hour meter, enter the total estimated hours.
  - c. LAST OIL CHANGE. Enter the hours since the last oil change. If the equipment does not have an hour meter, estimate the hours.
6. REASON FOR SAMPLE. Enter the word ROUTINE for routine samples. Enter the word SPECIAL for lab-directed samples.

Figure 5-15. Sample DA Form 2408-20 (back)

7. RESULTS. Enter the results of the lab analysis: normal, maintenance recommended by the lab, component removed, send in another sample, and so on. If more room is needed, use the Remarks block (block 9).
8. RESULTS RECEIVED.
- a. DATE. Enter the calendar date when posting lab results or other actions.
- b. PID. The person making the entries, or their supervisor, signs first initial and last name.
9. REMARKS. Use this block for:
- a. Lab results, when more space is needed in column 7.
- b. Hour meter changes. With a one-line entry, show the total hours on the item when the hour meter was changed. Also show any hours on the new meter at that time.
- c. Date of the oil change. When starting a new form, unless the first entry is an oil change, enter in pencil the date and hours on the item when the oil was last changed, and the type of oil.
- d. Equipment under warranty. Note warranty-required oil or oil filter change intervals or other needed warranty information.
- e. Components under warranty. For components under warranty, print Warranty item and period (miles, hours, month) the warranty applies. The Warranty Control Office or Logistics Assistance Office can tell if an item is under warranty and for how long. While equipment is under warranty, change the oil and oil filter as directed by the warranty contract. Do not wait for lab recommended changes. More frequent oil changes directed by the lab are allowed. Any maintenance action recommended by the lab for warranted items must be referred to the AOAP monitor and Warranty Control Office.

Figure 5-15. Sample DA Form 2408-20 (back)

AMMUNITION DATA CARD				Form Approved OMB No. 0704-0188	
<small>The public reporting burden for this collection of information is estimated to average 14 minutes per response, including the time for reviewing instructions, searching existing data sources, gathering and maintaining the data needed, and completing and reviewing the collection of information. Send comments regarding this burden estimate or any other aspect of this collection of information, including suggestions for reducing the burden, to Department of Defense, Washington Headquarters Services, Directorate for Information Operations and Reports (0704-0188), 1215 Jefferson Davis Highway, Suite 1204, Arlington, VA 22202-4302. Respondents should be aware that notwithstanding any other provision of law, no person shall be subject to any penalty for failing to comply with a collection of information if it does not display a currently valid OMB control number. PLEASE DO NOT RETURN YOUR FORM TO THIS ADDRESS.</small>					
1. ITEM NOMENCLATURE GUIDED MISSILE, SURFACE ATTACK		2. NSN 1427-01-422-7617	3. DODIC PL34	4. LOT NUMBER MGP97M005-001	
5. MANUFACTURER, LOADING OR ASSEMBLY ACTIVITY LOCKHEED MARTIN TECHNOLOGIES			6. NET QUANTITY 4	7. PACKING OF LOT SPI NO. AL14227617REV D	
8. CONTRACT OR ORDER NO. DAAH01-96-C-0147		9. DRAWING AND REVISION 13303050-029 T NOR 17		10. SPECIFICATION AND REVISION MIS-42599 V	
11. DATE STARTED 1 DEC 1997		12. DATE COMPLETED 8 DEC 1997	13. DATE INSPECTED 8 DEC 1997	14. LINE JV	15. ZONE WEIGHT N/A
16. SPECIFICATIONS					
a. CHARGE WEIGHT N/A	b. INDEX OF POWDER N/A	c. MAXIMUM PACKING DEPTH IN INCHES N/A	d. PRODUCTION PACKING DEPTH RANGE IN INCHES N/A	e. EXPLOSIVE WEIGHT PER PACKAGE 8.07	
17. TEST SAMPLES					
a. NUMBER N/A	b. SENT TO N/A		c. DATE SHIPPED N/A	d. MODE OF SHIPMENT N/A	
18. DOT NOMENCLATURE ROCKETS		19. HAZARD CLASS 1.2E	20. GOVERNMENT QUALITY ASSURANCE ACTIVITY DCMC		
21. REMARKS SERIAL NUMBERS: 310028, 310041, 310043, 310045					
22. DISPOSITION ACCEPTED		23. GOVERNMENT INSPECTOR			
		a. TYPED NAME R.MASTERS	b. SIGNATURE		c. DATE SIGNED

DD FORM 1650, AUG 96

PREVIOUS EDITION MAY BE USED.

Figure 5-16. Sample DD Form 1650 (front)

24. COMPONENTS					
a. COMPONENT	b. DRAWING NO.	c. MANUFACTURER	d. DATE MFG.	e. LOT NO.	f. QUANTITY
WARHEAD INIT MOD	13312303	MOTOROLA SSTG	20 DEC 1996	MGG97G004004	4
	13312303	MOTOROLA SSTG	20 DEC 1996	MGG97F003003	3
	13305033	MAGNAVOX ELEC	13 MAR 1997	MN-97C002018	1
MISSILE RESTRAINT SQUIB	13305290	SPEC DEV, INC	1 JUN 1997	SEB97F001011	4
MAIN CHARGE WARHEAD ASSY	13304400	MASON & HANGER	3 SEP 1997	MHM97J005001	4
PRECURSOR WARHEAD ASSY	13497449	HITECH, INC.	30 DEC 1996	ITH96M001003	4
PROPULSION SECTION	13304900	ATLANTIC RSRCH	12 OCT 1995	ATL95K002009C	1
	13304900	ATLANTIC RSRCH	10 FEB 1997	ATL97B002020	1
	13304900	ATLANTIC RSRCH	13 FEB 1996	ATL96B002012A	2
BATTERY COOLANT UNIT	13303250	CARLETON TECH	1 APR 1997	CGI97E001001	4
ON BOARD VOLUME	13307507	CONAX FLA CROP	20 AUG 1997	97H2-01	3
	13307507	CONAX FLA CROP	1 SEP 1997	97J3-01	1
THERMAL BATTERY	13304850	EAGLE PITCHER	3 MAR 1997	EPH97C001029	4

DD FORM 1650 (BACK), AUG 96

Notes:

<sup>1</sup> Use block 21 to note any unusual facts about the lot.

Legend for Figure 5-16;

completion instructions follow. Blocks 1-23 are filled out using MIL-STD-1168B. MIL-STD-1168B directs the use and explains how to fill out DD Form 1650. The instructions below explain how to carry component changes on each card.

24. COMPONENTS.

- a. COMPONENT. Enter the approved item name. A separate line is used for each serial numbered component, subassembly or assembly
- b. DRAWING NO. List the drawing number, revision letter, and applied engineering orders, if the item has any.
- c. MANUFACTURER. List the manufacturer of each lot for each component used. (If any parts come from a supplier other than the one listed in block 5, a complete loaded item description must be given.)
- d. DATE OF MFG. Enter the month and year (if known) each lot of each component was made.
- e. LOT NO. Enter the complete lot number or serial number of each component use in loading the item. When a serial numbered component is replaced, line through the old component and list the new component below the last component listed following instructions for blocks 24a-24f.
- f. QUANTITY. Give the quantity from each lot, within 5 percent. Leave blank when all the components of each type are from the same lot.

Figure 5-16. Sample DD Form 1650 (back)—Continued

## Chapter 6 Watercraft and Amphibious Lighters Records and Procedures

### 6-1. General

a. This chapter gives instructions on how to use and distribute records and reports on U.S. Army watercraft. All Army watercraft are divided into the following three classes:

- (1) Class A watercraft are self-propelled and are 65 feet or over in length.
- (2) Class B watercraft are self-propelled and under 65 feet in length. (Including landing craft mechanized and amphibious lighters.)
- (3) Class C watercraft are all floating equipment not self-propelled. (For example, floating machine shops and cranes, dry-liquid, and refrigerated cargo barges.) Class C watercraft are divided into the following two categories:
  - (a) Class C-1 are nonpropelled watercraft with berthing facilities and/or machinery on board.

(b) Class C-2 are nonpropelled watercraft with neither berthing facilities nor machinery on board.

b. General and specific instructions are given for the following forms as they apply to watercraft and amphibious lighters:

(1) All Army watercraft (except bridge erection boats, transporters, and mobile-assault bridges) are shown on all forms by the watercraft name (if one is assigned) and the Army hull and design numbers. For bridge erection boats, transporters, and mobile-assault bridges, use the model and serial number.

(2) DD Form 314 is not used on watercraft. Maintenance scheduling and recording of NMCS/NMCM data are kept by approved STAMIS systems and the logbook instructions.

(3) DA Form 4640 (Harbor Boat Deck Department Log for Class A and C-1 Vessels) is used on Class A and Class C watercraft. DA Form 4993 (Harbor Boat and Engine Department Log for Class A and C-1 Vessels) is used on all Class A and C watercraft.

(a) DA Form 5273 (Harbor Boat Deck and Engine Log for Class B Vessels) must be used on all Class B vessels.

(b) Class C vessels designated as fuel barges must use DA Form 5273 instead of DA Forms 4640 and 4993. Marine logbooks for Class C vessels designated BC, BCDK, BK, CF, FCP, and RRDF are not required.

(c) Instructions for filling out and disposition of these forms are in the logbook and in AR 56-9.

(4) DA Form 5587 (Report of Dry docking, Painting, and Condition of Vessel Bottom) is used to provide a record of cyclic maintenance and the condition of a watercraft's bottom, zinc protectors, rudders, propellers, struts, shafting and shaft bearing, sea valves, and paint system.

(a) A Report of Drydocking is prepared after each scheduled or unscheduled dry-docking of all propelled and nonpropelled U.S. Army watercraft.

(b) DA Form 5587 instructions are outlined in figure 6-1. The required information can be obtained from the watercraft maintenance file and during dry-docking or repair. The form must be prepared by the marine surveyor or Government representative during the dry-docking and be approved by his or her supervisor. Copies are distributed as follows:

1. One copy remains aboard the watercraft or in the units file.

2. One copy is retained in the watercraft's file at the support maintenance office completing the marine condition survey or dry-docking.

3. One copy is forwarded to the National Maintenance Point (NMP), TACOM), ATTN: AMSTA-LC-CJA, Warren, MI 48397-5000. This copy is due within 30 days of refloating the watercraft.

4. Logbooks are used on all Army watercraft, except bridge erection boats, transporters, and mobile-assault bridges. Instructions for preparing, using, and distributing the forms are found in this pamphlet, AR 56-9, AR 700-138, and logbooks.

5. Logbooks are used, kept, and normally stored on board all Class A, B, and C-1 watercraft. When storing watercraft, remove logbooks and all other records for security purposes and store at the using/storage activity. Replace the records and logbooks when watercraft is reissued. Army watercraft use the following maintenance forms:

a. DA Form 2402 (chap 3).

b. DA Form 5988-E/DA Form 2404 (chap 3).

c. DA Form 2405 (chap 3).

d. DA Form 2406 (AR 700-138).

e. DA Form 5990-E/DA Forms 2407/2407-1 (chaps 3).

f. DA Form 2408-9 (chap 5).

g. SF 368.

h. DA Form 3590 (Request for Distribution or Waiver) and TB 43-0140.

## **6-2. Reporting of accidents/incidents**

All accidents and/or incidents of watercraft are reported per AR 55-19 and AR 385-40.

## **6-3. Component record**

a. A data bank keeping all records of components that apply to certain end items are kept at the NMP in the Watercraft Information Reporting System (WIRS). A WIRS printout is sent annually to the using unit for review and update. The review and update is completed by: the watercraft master, marine maintenance officer, or engineer. Changes to the component list are marked on the WIRS printout, signed by the reviewer, and sent back to the NMP within 30 days after it is received.

b. A list of the selected end items, their components, and instructions on how to prepare, use, and dispose of the computer printout is found in TB 55-1900-205-24.

**6-4. Request for disposition and/or waiver**

- a.* A request for disposition and/or waiver is submitted to the NMP/national inventory control point (NICP) on DA Form 3590. Policies and procedures for the use of this form are contained in TB 43-0140.
- b.* All such requests are forwarded through normal command channels to the NMP, TACOM, ATTN: AMSTA-LC-CJA, Warren, MI 48397-5000.

REPORT OF DRYDOCKING, PAINTING AND CONDITION OF VESSEL BOTTOM (FROM KEEL TO TOP OF BOOT TOP LINE) <small>For use of this form, see DA PAM 750-8; the proponent agency is DCS, G-4.</small>		REPORTS CONTROL SYMBOL CSGLD-1943	
		DATE	20040624
TO: COMMANDER, USATACOM ATTN: AMSTA-LC-CJW, BLDG 230 Warren, MI 48397-5000		FROM: USATACOM Watercraft Inspection Branch ATTN: AMSTA-LC-CJWW, BLDG 2796 Fort Eustis, VA 23604-5598	
NAME OF VESSEL/HULL NUMBER/DESIGN NUMBER  US ARMY VESSEL (EL CANEY), LCU-2017		COMMAND: 558th Transportation Company  STATION: Fort Eustis, VA  LOCATION: Fort Eustis, VA	
SECTION I - DRYDOCKING AND PAINTING DATA			
LOCATION OF PRESENT DD OR HAUL OUT Yonges Island, SC		CONTRACTOR'S NAME Metal Trades, Inc.	
LOCATION LAST DD OR HAUL OUT Yonges Island, SC (Metal Trades Inc.)		DATE OF LAST DD 20001201	DATE OF PRESENT DD 20040501
TIME ELAPSED SINCE LAST PAINTING (Mos & Days) 42 months, 5 days		COST OF CLEANING & PAINTING OF UNDERWATER AREA \$107,406.00	
		DATE REFOATED 20040624	
		COST OF PRESENT DD \$6480.00	
STATE FULLY CONDITION OF THE UNDERWATER HULL PLATES Moderate pitting in areas of keel coolers' installations. Minor isolated areas of pitting overall on hull plates. Moderate pitting in chine weld seams, frames 23-39, port and starboard sides.			
SECTION II - CONDITION OF UNDERWATER FITTINGS			
OUTBOARD SHAFTING AND SLEEVES (P) & (S) Unsatisfactory		SIZE OF SHAFT 21' x 3/4"	DATE TAIL SHAFT LAST DRAWN 19981005
RUDDER(S) (P) & (S) Unsatisfactory		RENEWED AT THIS DOCKING <input checked="" type="checkbox"/> YES <input type="checkbox"/> NO	
RUDDERS PINTLE BEARINGS AND GUDGEONS (P) & (S) Unsatisfactory		SIZE & PITCH 68" dia. x 63.36" pitch	
PROPELLERS (P) & (S) Unsatisfactory (1 R.H., 1 L.H.)		PROPELLERS STRUTS (P) & (S) Unsatisfactory	
OUTBOARD STERN BEARING(S) AT DOCKING (P) & (S) Unsatisfactory - bearings replaced this drydock		PRIOR TO FLOATING (P) & (S) Satisfactory	
HOW MUCH WEAR (Thousandths of an inch) (P) Tube (.005), Strut (.008); (S) Tube (.009) Strut (.010)		DATE LAST CUTLASS RUBBER RENEWED 20040611	
SEA STRAINERS Overhauled		RENEWED AT THE DOCKING <input type="checkbox"/> YES <input checked="" type="checkbox"/> NO	
SEA CHESTS AND VALVES Eight inch gate valve and eight inch swing check valve at Main Sea Chest replaced.			
HULL ZINCS	SIZE 1 1/4" x 6" x 12"	NUMBER 36	TYPE ZHC-23
		RENEWED AT THE DOCKING <input checked="" type="checkbox"/> YES <input type="checkbox"/> NO	
ZINC BARS AT SEA CHESTS/KEEL COOLERS	SIZE 1 1/4" x 6" x 12"	NUMBER 2	TYPE ZHC-23
		RENEWED AT THE DOCKING <input checked="" type="checkbox"/> YES <input type="checkbox"/> NO	
BILGE KEELS (P) & (S) Satisfactory			
STERN FRAME/SKEG/KORT NOZZLE Stern Frame Satisfactory / Skegs Satisfactory			
<small>Where two or more shafts are fitted, report separately the condition of propellers, shafting, stern and strut bearings, zincs, rings, struts, etc. Indicate starboard (S) or port (P) as applicable.</small>			

DA FORM 5587, AUG 2004

DA FORM 5587-R EDITION OF NOV 86, IS OBSOLETE.

APD V1.00

Figure 6-1. Sample DA Form 5587 (front)

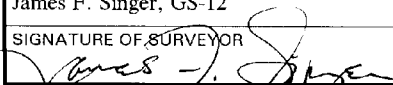
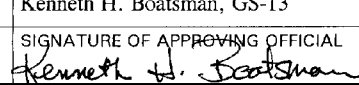
SECTION III - BOTTOM FOULING							
PLANT <input type="checkbox"/> Heavy <input type="checkbox"/> Moderate <input checked="" type="checkbox"/> Slight		ANIMAL <input type="checkbox"/> Heavy <input type="checkbox"/> Moderate <input type="checkbox"/> Slight		CONDITION AND TYPE OF FOULING  Minor growth overall			
SECTION IV - PAINT RECORD							
WEATHER CONDITION (Temp/Humidity) 78 Degrees / 52%				SANDBLAST TO NEAR WHITE METAL <input checked="" type="checkbox"/> YES <input type="checkbox"/> NO			
IF FULLY REPAINTED		NO. OF COATS	MANUFACTURER	FORMULA	GAL USED		
		1	Finnaren and Haley	822UW	60		
		1	Finnaren and Haley	822UW	60		
		1	Finnaren and Haley	Inducote	55		
		1	Finnaren and Haley	Inducote	55		
		1	Finnaren and Haley	Inducote	55		
IF SPOT PAINT ONLY		NO. OF COATS	MANUFACTURER	FORMULA	GAL USED		
TIME FACTORS		COATS					
		1-2	2-3	3-4	4-5	5-6	6-7
Time Between Each Coat (Hrs)		40	6	24	24		
Length of Time to Complete Painting		14 Days					
Time Between Last Coat and Refloating		13 Days					
REMARKS							
1. Replaced Hull Zincs. Vessel shifted on blocks for 100% underwater cleaning and painting. 2. Ballast Tanks power tool cleaned and painted. 3. Six Zinc anodes (ZHC-23). Each replaced on port and starboard rudders. 4. Bow thruster lube oil tank modification accomplished. 5. Port and Starboard propeller shafts overhauled. Moderate wear/pitting in starboard packing gland area repaired. Severe wear/pitting in area of port packing gland repaired. 6. Port and Starboard propellers overhauled. 7. Clad welding accomplished on bottom plating in areas of keel coolers installation as well as weld seam in beaching area and along chine weld seams, frame 23- frame 39, port and starboard sides. 8. Leading edge of port rudder replaced. 9. Nylon rudder bearings replaced. Thordon bearings installed to rudders. 10. Port and Starboard strut and stern tube bearings replaced. 11. Eight inch valve gate and eight inch check valve at main sea chest replaced.							
TYPED NAME AND GRADE OF SURVEYOR James F. Singer, GS-12				TYPED NAME AND GRADE OF APPROVING OFFICIAL Kenneth H. Boatsman, GS-13			
SIGNATURE OF SURVEYOR 				SIGNATURE OF APPROVING OFFICIAL 			

REVERSE OF DA FORM 5587, AUG 2004

APD V1.00

Legend for Figure 6-1;  
completion instructions follow.

DATE. Enter the date that the report is filled out (yyyy/mm/dd)

Figure 6-1. Sample DA Form 5587 (reverse)

TO. The activity performing the inspection and cyclic maintenance enters: Commander, TACOM, ATTN: AMSTA-LC-CJW, Bldg 230, Warren, MI 48397-5000.

FROM. Enter the activity and address that performed the inspection and cyclic maintenance.

NAME OF VESSEL/HULL NUMBER/DESIGN NUMBER. Enter the vessel name (example: Col Seth Warner), and hull number (example: LT-806), and design number if known.

COMMAND. Enter the Major Command, example 73rd Transportation Command.

STATION. Enter the current station of the vessel. Enter a city and state. If overseas, enter the city and country.

LOCATION. Enter the current location of the vessel. Enter a city and state. If overseas, enter the city and country.

#### SECTION I—DRYDOCKING AND PAINTING DATA

1. LOCATION OF PRESENT DD OR HAUL OUT. Enter the location of the vessels present in drydock or haul-out location. Enter a city and state. If overseas, enter the city and country.

2. CONTRACTOR'S NAME. Enter the name of the contractor who stored the vessel and performed any cleaning and painting work. If more than one contractor was used, enter the name of the contractor who drydocked the vessel first and then add the name of the contractor who cleaned or painted.

3. LOCATION OF LAST DD OR HAUL OUT. Enter the location of the vessels present in drydock or haul-out location. Enter the city and state. If overseas, enter the city and country.

4. DATE OF LAST DD. Enter the date (yyyy/mm/dd) of the last drydock.

5. DATE OF PRESENT DD. Enter the date (yyyy/mm/dd) of the current drydock.

6. DATE REFLOATED. Enter the date (yyyy/mm/dd) that the vessel was refloated.

7. TIME ELAPSED SINCE LAST PAINTING (*Mos & Days*). Enter the months and days since the last date the hull was painted.

8. COST OF CLEANING & PAINTING UNDERWATER AREA. Enter the cost of cleaning and painting the underwater areas.

9. COST OF PRESENT DD. Enter the cost of the current drydock.

10. STATE FULLY CONDITION OF THE UNDERWATER HULL PLATES. Enter a detailed description of the condition of the vessels hull plates.

#### SECTION II—CONDITION OF UNDERWATER FITTINGS.

1. OUTBOARD SHAFTING AND SLEEVES. Enter either satisfactory or unsatisfactory. If unsatisfactory, then, state why in the area provided or the remarks section.

2. SIZE OF SHAFT. Enter the size in feet and inches (length by diameter); for example, 382 ft x 10 in.

3. DATE TAIL SHAFT LAST DRAWN. Enter the date (yyyy/mm/dd) that the tail shaft was last drawn.

4. RUDDER(S). Enter either satisfactory or unsatisfactory. If unsatisfactory, then, state why in the area provided or the remarks section.

5. RUDDERS, PINTLE BEARINGS, AND GUDGEONS. Enter either satisfactory or unsatisfactory. If unsatisfactory, then, state why in the area provided or the remarks section.

6. RENEWED AT THIS DOCKING. Check either yes or no.

7. PROPELLERS. Enter either satisfactory or unsatisfactory. If unsatisfactory, then, state why in the area provided or the remarks section.

8. SIZE & PITCH. Enter the size and pitch of the propellers in feet and inches; for example, 111 in x 92.40 in.

9. PROPELLER STRUTS. Enter either satisfactory or unsatisfactory. If unsatisfactory, then, state why in the area provided or the remarks section.

10. OUTBOARD STERN BEARING(S) AT DOCKING. Enter either satisfactory or unsatisfactory. If unsatisfactory, then, state why in the area provided or the remarks section.

11. PRIOR TO FLOATING. Enter either satisfactory or unsatisfactory. If unsatisfactory, then, state why in the area provided or the remarks section. Use (P) for port and (S) for starboard as appropriate; for example, (P) & (S) satisfactory.

12. HOW MUCH WEAR (*Thousandths of an inch*). Enter as appropriate.

13. DATE LAST CUTLASS RUBBER RENEWED. Enter as the date (yyyy/mm/dd).

14. SEA STRAINERS. Enter as appropriate.

15. RENEWED AT THIS DOCKING. Check yes or no.

16. SEA CHEST AND VALVES. Enter as appropriate.

17. HULL ZINCS. Enter as appropriate.

18. SIZE. Enter as appropriate.

19. NUMBER. Enter as appropriate.

20. TYPE. Enter as appropriate.

21. RENEWED AT THIS DOCKING. Check either yes or no.

22. ZINC BARS AT SEA. Enter as appropriate.

23. SIZE. Enter as appropriate.

24. NUMBER. Enter as appropriate.

25. TYPE. Enter as appropriate.

26. RENEWED AT THIS DOCKING. Check either yes or no.

27. BILGE KEELS. Enter either satisfactory or unsatisfactory. If unsatisfactory, then, state why in the area provided or the remarks section.

**Figure 6-1. Sample DA Form 5587 (reverse)**



28. STERN FRAME/SKEG/KORT NOZZLE. Enter either satisfactory or unsatisfactory. If unsatisfactory, then, state why in the area provided or the remarks section.

SECTION III—BOTTOM FOULING.

1. PLANT. Mark an X in the appropriate box that best describes the vessel bottom fouling, (heavy, moderate or slight).
2. ANIMAL. Mark an X in the appropriate box that best describes the vessel bottom fouling, (heavy, moderate or slight).
3. CONDITION AND TYPE OF FOULING. Enter a brief description.

SECTION IV—PAINT RECORD.

1. WEATHER CONDITION (Temp/Humidity). Enter the average temperature (degrees Fahrenheit) and percent humidity; for example, 82 degrees, 52 percent.
  2. SANDBLAST TO NEAR WHITE METAL. Enter an X in the appropriate box YES or NO.
  3. IF FULLY REPAINTED. Enter each coat (pretreatment, anticorrosive/primer, antifouling, and boot topping) on a separate line in the corresponding columns. Enter one of the following:
    - a. NO. OF COATS. Enter the number of coats that were applied.
    - b. MANUFACTURER. Enter the paint manufacturer.
    - c. FORMULA. Enter the formula used.
    - d. GAL USED. Enter the number of gallons used.
  4. IF SPOT PAINT ONLY. Enter each coat (pretreatment, anticorrosive/primer, antifouling, and boot topping) on a separate line in the corresponding columns. Enter one the following:
    - a. NO. OF COATS. Enter the number of coats that were applied.
    - b. MANUFACTURER. Enter the manufacturer who made the paint.
    - c. FORMULA. Enter the specific formula used.
    - d. GAL USED. Enter the number of gallons of paint used.
  5. TIME FACTORS.
    - a. Time Between Each Coat (*Hrs*). Enter the number of hours in the correlating box for the number of hours between coats of primer, and so on.
    - b. Length of Time to Complete Painting. Enter the total length of time to complete all painting.
    - c. Time Between Last Coat and Refloating. Enter the total length of time between the last coat and refloating of the vessel.
- REMARKS. Enter any remarks that would not fit in appropriate sections blocks or other pertinent information.
- TYPED NAME AND GRADE OF SURVEYOR. Print the name, grade and phone number of the surveyor.
- SIGNATURE OF SURVEYOR. Self explanatory.
- TYPED NAME AND GRADE OF APPROVING OFFICIAL. Print the name, grade, and phone number of the approving official.
- SIGNATURE OF APPROVING OFFICIAL. Self explanatory.

Figure 6–1. Sample DA Form 5587 (reverse)

---

## Chapter 7 Rail Equipment Records and Procedures

### 7–1. General rail equipment forms

- a. This chapter tells how to prepare, use, and dispose of forms and worksheets for Army rail equipment. Army rail equipment includes diesel electric locomotives, locomotive cranes, freight, passenger and maintenance equipment, and cars under the control of the Department of the Army.
- b. When filling out the forms on an end item of rail equipment, use the road number when the form asks for the serial number.
- c. When rail equipment uses the same forms as other equipment, refer to the paragraph on that form.
- d. Army-owned rail equipment uses the following forms:
  - (1) DD Form 1970 (see chap 2).
  - (2) DA Forms 2407/2407–1 (see chap 3). Defense Railway Interchange Fleet, controlled by the Military Traffic Management Command, uses DA Form 2407 for reporting applied MWOs.
  - (3) DA Form 2408–9 (see chap 5).
  - (4) DA Form 2408–20 (see chap 5).
  - (5) DD Form 862 (Daily Inspection Worksheet for Diesel Electric Locomotives and Locomotive Cranes). Instructions for DD Form 862 are provided in this chapter.
  - (6) DD Form 1335 (Field Inspection Data USA, USAX, USNX, DODX Rail Cars). Instructions for DD Form 1335 are provided in this chapter.
  - (7) Federal Railroad Administration (FRA) Form F6180–49A (Locomotive Inspection and Repair Record). Instructions for Form FRA F6180–49A are provided in this chapter.

(8) SF Form 368 (see chap 10).

## **7-2. Preparation of forms**

*a.* Qualified personnel complete these forms. Qualified personnel are individuals, no less than journeyman level, with a working knowledge and hands-on experience of diesel engines, electrical systems, air systems, and so on, that pertain solely to locomotives, railway cranes, and rolling stock. No individuals below journeyman level may make entries.

*b.* A troop rail support unit normally does periodic services on rail equipment. When no troop rail support unit is available, mobile rail repair shops or commercial contractors perform the work.

*c.* The DOT directs that only supervisors countersign entries.

*d.* Rail equipment operating in foreign countries are maintained as directed by the rules and regulations of that country (see AR 750-1).

## **7-3. DD Form 862 (Daily Inspection Worksheet for Diesel Electronic Locomotives and Locomotive Cranes)**

*a. Purpose.* DD Form 862 provides a means of keeping up with diesel electric locomotives and locomotive crane operation, services, and lubrication.

*b. Use.*

(1) Operator and maintenance people use DD Form 862 for daily inspections of locomotives and locomotive cranes (fig 7-1).

(2) DD Form 862 also shows faults found and repairs made.

*c. General information.*

(1) DD Form 862 is filled out daily when a locomotive or locomotive crane is used.

(2) When the equipment is not used, no form is needed.

(3) All entries on DD Form 862 are printed or typed using black ballpoint pen or typewriter.

(4) When turning in or transferring Railway equipment, that is, major items, submit a DA Form 2408-9 to LOGSA. Submit the following forms to TACOM (Item Manager):

(*a.*) DA Form 2404.

(*b.*) DA Form 3590.

(*c.*) DA Form 4615 (Vehicle Classification Inspection).

(*d.*) SF 120 (Report of Excess Personal Property).

*d. Disposition.* Keep DD Form 862 on file until the next 92-day inspection is done. Then destroy the form.

## **7-4. DD Form 1335**

*a. Purpose.* DD Form 1335 ( fig 7-2) provides a basic checklist for inspections of railway cars by using organizations in conjunction with information supported by DA Form 2407. Inspectors are exempt from using DA form 2407.

*b. Use.* DD Form 1335 is used as a checklist for maintenance inspections of railway cars. The checklist is supported by information on DA Form 2407.

*c. Frequency.* Inspections should be accomplished on cars at frequencies prescribed by TM 55-203, chapter 16.

*d. Disposition.* DD Forms 1335 are retained by the using organization for 2 years and then are destroyed.

## **7-5. Form FRA F6180-49A**

*a. Purpose.* Form FRA F6180-49A shows the condition of locomotives and locomotive cranes. This form also shows if the equipment complies with FRA and DOT regulations.

*b. Use.* Form FRA F6180-49A has two uses. It is used to show that the equipment complies with regulations. It is also used as a record of maintenance and repairs required by the FRA and the DOT (fig 7-3).

*c. General instructions.*

(1) Qualified personnel make a 92-day Periodic Report.

(2) Qualified DS and GS or depot-level personnel make the Annual Report in duplicate. The Annual Report is also made out after each depot overhaul.

(3) The qualified person making the inspection also signs the form.

(4) The officer in charge countersigns Form FRA F6180-49A. If a non-Army organization does the work, the supervisor countersigns.

(5) Form FRA F6180-49A can be obtained from the FRA.

*d. Disposition.*

(1) The original copy of the report stays in the cab of the equipment. Protect the form with a clear cover.

(2) Keep one copy of the current updated form on file at the user level until the next periodic inspection has been completed and a copy of the latest Form FRA F6180-49A is filed.



B - MAINTAINER'S REPORT (Continued)							
ITEMS	CHECK ONE		CORRECTED (Mechanic's Initials)	ITEMS	CHECK ONE		CORRECTED (Mechanic's Initials)
	OK	DEFEC- TIVE			OK	DEFEC- TIVE	
12. Loose Bolts, Nuts and Pins	✓			19. Check Engine Warm Up	✓		
13. All hoses and Belts	✓			20. Check Friction Clutches	—	—	
14. Leaks	✓			21. Check Air Operated Clutches	—	—	
a. Fuel and Lube Systems	✓			22. Check Turntable	—	—	
b. Cooling System	✓			23. Check Boom and Hoisting Brakes	—	—	
c. Air System	✓			24. Rollers and Pins	—	—	
d. Intake and Exhaust System	✓			25. Cables and Sheaves	—	—	
15. Wheels and Journals	✓			26. Hook or Bucket	—	—	
16. Drain Moisture from Air Reservoirs & Intercoolers	✓			27. Transmission	—	—	
17. Drain Air Boxes and Check Operations of Crankcase Exhauster	✓						
18. Check for Unusual Noises	✓						
C - ADDITIONAL WORK OR OTHER QUALIFYING DATA							
REMARKS							
D - AUTHENTICATION							
SIGNATURE OF INSPECTOR <i>Bonnie Wright</i>				SIGNATURE OF FOREMAN <i>James Lyles</i>			

DD FORM 862 (BACK), MAY 1994

USAPA V1.00

Legend for Figure 7-1;  
completion instructions follow.  
UNIT NUMBER. Enter noun abbreviation and unit number.  
OPERATION HRS. Total hours of actual operation per day.  
DATE. Current days calendar date.

Figure 7-1. Sample DD Form 862 (back)—Continued

INSTALLATION. Assigned location.

A—OPERATORS REPORT

ITEM NUMBER. List in numerical sequence.

REPAIRS NEEDED (*Reported by Road Inspector or Operator*). Describe the fault or problem.

CORRECTED (*Mechanics Initials*). Qualified mechanics initials.

1. CLEAN UNIT. Mark yes or no.

2. LUBE OIL PRESSURE: NUMBER 1/NUMBER 2. Enter OK if engine lube oil pressure is normal as specified by manufacturer after initial warm up. If defective, enter DEF and explain the problem in the Remarks block on backside of form.

3. WATER TEMPERATURE: NUMBER 1/NUMBER 2. Enter OK if engine temperature is normal as specified by the manufacturer after initial warm up. If defective, enter DEF and explain problem in Remarks block on backside of form.

4. BATTERY AMMETER: NUMBER 1/NUMBER 2. Enter OK if charging. If defective, enter DEF and explain problem in REMARKS block on backside of form.

5. LOAD METER: NUMBER 1/NUMBER 2. If operational, enter OK. If defective, enter DEF and explain problem in Remarks block on backside of form.

6. MAIN RESERVOIR PRESSURE. Enter PSI for main reservoir pressure.

7. EQUALIZING RESERVOIR PRESSURE. Enter PSI for equalizing reservoir pressure.

8. BRAKE PIPE PRESSURE. Enter PSI for brake pipe pressure.

9. CONTROL AIR PRESSURE. Enter PSI for control air pressure.

SIGNATURE OF ROAD INSPECTOR. Leave blank.

SIGNATURE OF OPERATOR. Sign name legibly.

B—MAINTAINER'S REPORT. Read all items 1 through 27.

ITEMS.

CHECK ONE: OK/DEFECTIVE. Make check mark in OK or defective blocks.

CORRECTED (*Mechanics Initials*). Enter initials of qualified mechanic doing the work.

C—ADDITIONAL WORK OR OTHER QUALIFYING DATA

REMARKS. Note any work done that was not listed in B. Note information for future use.

D—AUTHENTICATION

SIGNATURE OF INSPECTOR. Signature of qualified rail inspector.

SIGNATURE OF FOREMAN. Signature of foreman.

**Figure 7-1. Sample DD Form 862 (back)—Continued**

---

FIELD INSPECTION DATA USA, USAX, USNX, DODX RAIL CARS				NAME OF INSPECTOR JOHN DOE		SHOP AMCXXX	
CLASS TYPE I		INSPECTION LOCATION ST. LOUIS MO			DATE 1 JULY 00		CAR NUMBER USAX 2 8059
TEST		PRESSURE		GAL	LWT		LDMT
TANK 1 JULY 00	VALVE 1 JULY 00	TANK 250	VALVE 75	10,000	40,000 LB		137,000
AIR DATE 1 JULY 00		JOURNAL PADS 1 JULY 97		TYPE OIL WELL	DATE BUILT 1-44	DATE LAST INSP 1 JULY 99	ACI <input type="checkbox"/> YES <input type="checkbox"/> NO
ITEM	CONDITION			REMARKS (Check)			
	SAT	RPR	RENEW				
TANK SHELL LEAKING				<input type="checkbox"/> YES	<input type="checkbox"/> NO		
SLABBING <input type="checkbox"/> METAL <input type="checkbox"/> WOOD	<input checked="" type="checkbox"/>			<input type="checkbox"/> DECAYED	<input type="checkbox"/> MISSING		
RUNNING BOARD <input type="checkbox"/> METAL <input type="checkbox"/> WOOD	<input checked="" type="checkbox"/>			<input type="checkbox"/> RIVETS LOOSE			
TANK BANDS				<input type="checkbox"/> LOOSE	<input type="checkbox"/> BROKEN		
DECK/LINING				DATE		TYPE	
SILL STEPS/GRAB IRONS/HAND RAILS, LADDERS				<input type="checkbox"/> LOOSE	<input type="checkbox"/> BENT	<input type="checkbox"/> BROKEN	
COUPLERS, SHANK, SIDEWALL, KNUCKLES, PINS, LOCKLIFT				<input type="checkbox"/> WORN	<input type="checkbox"/> CRACKED	<input type="checkbox"/> ALINEMENT	
STRIKER CASTINGS				<input type="checkbox"/> CRACKED	<input type="checkbox"/> BROKEN	<input type="checkbox"/> LOOSE RIVETS	
DRAFT GEAR, YOKE, FOLLOWER, KEY, CUSHIONING DEVICE				<input type="checkbox"/> WORN	<input type="checkbox"/> BROKEN	<input type="checkbox"/> MISSING	
DRAFT LUGS				<input type="checkbox"/> POUNDING			
SIDE BEARINGS				<input type="checkbox"/> LOOSE RIVETS	<input type="checkbox"/> MISSING		
SIDE FRAME - BOLSTER - COLUMN GUIDES				<input type="checkbox"/> ADJUST	<input type="checkbox"/> MISSING	<input type="checkbox"/> NO CLEARANCE	
SPRING PACKAGE				<input type="checkbox"/> BROKEN	<input type="checkbox"/> PATCHED	<input type="checkbox"/> PLATED	
MODIFICATIONS STAKEPOCKETS <input type="checkbox"/> YES <input type="checkbox"/> NO				<input type="checkbox"/> STRIKING	<input type="checkbox"/> WORN		
HANDBRAKE SHAFT - WHEEL				<input type="checkbox"/> COM-PRESSED	<input type="checkbox"/> MISSING	<input type="checkbox"/> BROKEN	
WHEELS				<input type="checkbox"/> PLATES	<input type="checkbox"/> WOOD		
AXLES - JOURNALS				<input type="checkbox"/> SHIELDS	<input type="checkbox"/> STRAPS	OTHER (Specify)	
JOURNAL BOXES AND LUBRICATORS				<input type="checkbox"/> CRACKED	<input type="checkbox"/> BENT		
CENTER PLATES				<input type="checkbox"/> SHIM	<input type="checkbox"/> RR & R	<input type="checkbox"/> RENEW	
ROLLER BEARING, ADAPTORS, LUGS				<input type="checkbox"/> FLANGE	<input type="checkbox"/> CRACKED	<input type="checkbox"/> FLAT SPOTS	
DEFECT CARD HOLDER, PLACARD HOLDERS, ROUTE BOARDS				<input type="checkbox"/> THIN RIM			
PAINT CONDITION			<input checked="" type="checkbox"/>	<input type="checkbox"/> COLLAR	<input type="checkbox"/> HEAT	<input type="checkbox"/> R J STAMP	
MECHANICAL CONDITION CODE				<input type="checkbox"/> FILLET			
SIGNATURE OF EQUIPMENT SPECIALIST <i>John Doe</i>				<input type="checkbox"/> LOW OIL	<input type="checkbox"/> MISSING		
APPROVED <i>Mike Raitl</i>				<input type="checkbox"/> BROKEN	<input type="checkbox"/> LOOSE RIVETS		

DD FORM 1335, FEB 74

REPLACES DD FORM 1335, 1 SEP 60, WHICH IS OBSOLETE. USAPPC V1.00

Legend for Figure 7-2;  
completion instructions follow.  
NAME OF INSPECTOR. Print name legibly.

Figure 7-2. Sample DD Form 1335

SHOP. Name of installation.  
CLASS. Classification of Installation. For example Type 1, 2, and so on.  
INSPECTION LOCATION. City and State where located.  
DATE. Current day's calendar date.  
CAR NUMBER. Assigned USA or DODX number.  
TEST. Mark dates tested for tank and valve.  
PRESSURE. Mark tank pressure from 60 to 300 PSI, valve pressure 25 to 100 PSI.  
GAL. Capacity in gallons.  
LWT. Weight of car when not loaded.  
LDMT. Weight of car loaded.  
AIR DATE. Date of last air test.  
JOURNAL PADS. Date pads were last changed, if applicable.  
TYPE. Name of pad.  
DATE BUILT. The year the car was built.  
DATE LAST INSP. Date of last inspection performed.  
ACI. Leave blank.  
ITEM. Complete as necessary.  
CONDITION. Make a check mark in the blocks marked satisfactory, repair, or renew, as they apply.  
REMARKS (*Check*). Check appropriate block to match materials in item and condition columns.  
SIGNATURE OF EQUIPMENT SPECIALIST. Signature of qualified rail equipment inspector.  
APPROVED. Signature of approving official.

**Figure 7-2. Sample DD Form 1335**

---





Legend for Figure 7-3;

completion instructions follow.

Reporting year. Current years date.

Check if new loco. Make check mark if the locomotive is new.

If loco. renumbered give previous no. Place the previous number here. If it has not been renumbered, leave blank.

1. OPERATED BY. Enter city and state. RR CODE. Leave blank.

2. OWNED BY (*Railroad*). Enter owner, for example, U.S. Army, Air Force, Navy, Marine Corps, Defense Logistics Agency (DLA), or Reserve Components. RR CODE. leave blank.

3. MODEL NO. Type of locomotive or locomotive crane; for example 100-ton SW-8.

4. LOCO. NO. Assigned United States Army, U.S. Air Force, U.S. Navy, U.S. Marine Corps, or DLA number.

5. YR. BUILT. Original year built or date of remanufacture.

6. PROPELLED BY. Diesel Electric (D-E) or Diesel Mechanical (D-M).

7. HORESPOWER. Rated manufacturers amount.

8. TYPE OF SERVICE. Make check mark in the block that applies.

9. STEAM GEN. Not applicable. Print N/A for Gen #1 and Gen #2.

10. MAXIMUM PISTON TRAVEL. Print 6 inches.

11. OUT OF USE CREDIT. Print the number of days the locomotive or locomotive crane was not used in excess of 30 consecutive days during an inspection cycle.

12. LAST PERIODIC INSPECTION DATE. PLACE. Print the date the last 92-day inspection was performed. Enter the location. PERIODIC INSPECTIONS.

13. DATE: MO DAY YR. Print the date, month-day-year; for example 12-22-96.

14. PLACE. Note the installation where the inspection took place.

15. ITEMS. Refer to the item codes listed at the bottom of blocks 13 through 17 marked by a \*. Use the codes that apply, for example 1, 2, 3, 4, 5, and 7.

16. PERSON CONDUCTING. Name of qualified person conducting the rest of the inspection.

17. CERTIFIED BY. Name of qualified person authorized to certify that the inspection has been completed.

18. H&H TEST PRESSURE. Mark 190 lbs if test is done. If reservoirs are drilled, enter word drilled. Note: If locomotive is equipped with aluminum reservoirs, test pressure should be 250 PSI.

19. WAIVER PART 229. Print N/A.

20. WAIVER—OTHER. Print N/A.

21. PERSON CONDUCTING. Name of qualified person who completed the annual service.

22. TEST DATE AND PLACE. Print the month, day, year, and location where the annual service was completed.

23. CERTIFIED BY. The person authorized to certify the completion of work.

24. PREVIOUS TEST DATE AND PLACE. Print the last month, day, year, and location where the annual service was performed.

Certification of true copy. Enter the number of the locomotive worked on. Below that, enter the signature of the official in charge and responsible for the overall certification of the work, and date.

**Figure 7-3. Sample Form FRA F6180-49A**

---

## **Chapter 8 Ammunition Records and Reporting Procedures**

### **8-1. Records and reports**

*a.* This chapter describes how to prepare, use, maintain, and distribute records and reports on the following Army materiel:

- (1) Toxic chemical ammunition materiel.
- (2) Conventional ammunition.
- (3) Class V items of Guided Missiles and Large Rockets.
- (4) Ammunition peculiar equipment.

*b.* General and special instructions are given for the following forms for the above ammunition items:

- (1) DA Forms 2407/2407-1 (chap 3).
- (2) DA Form 2415 (Ammunition Condition Report).
- (3) DA Form 2402 (chap 3).
- (4) DA Form 2408-9 (chap 5).

### **8-2. Special instructions**

These instructions do not apply to ammunition malfunctions:

- a.* Malfunctions are reported in accordance with AR 75-1.

b. Accidents and incidents with chemical warfare ammunition are reported in accordance with AR 50–6 and command directives.

### **8–3. General instructions**

#### *a. Responsibility for submission.*

(1) Commanding officers of organizations using, handling, or storing ammunition, guided missiles, and large rockets prepare and submit timely ammunition reports to the appropriate command.

(2) For guided missiles and large rockets, the unit submits a DA Form 2407 for bad components. In addition, a DA Form 2415 may be required to comply with condition reporting identified in para 8–4.

#### *b. Classification.* Reports are classified by the latest security regulations (see AR 380–5 and AR 380–86).

#### *c. Acknowledge of receipt and replies.*

(1) Except as noted below, a final reply is given. Replies show the corrective action taken and direct action to be taken or state that no action is necessary. Replies also give disposition of defective items.

(2) Replies are not given for reports on unserviceable new materiel for which blanket shipping orders have been issued to return the item to the vendor.

*d. Forms.* The Air Force, Navy, and Defense Nuclear Agency organizations, that use Army designed or manufactured materiel and related instructions, may send in reports on their own service forms.

#### *e. Exhibits.*

(1) Exhibits are samples of an item with a discrepancy that is chosen to support materiel reports. The use of photographs, drawings, and supporting data in place of actual materiel exhibits is encouraged.

(2) Tag exhibits held for disposition instructions. A DA Form 2402 is used for tagging exhibits (except for ammunition lots to which SB 742–1 applies). For SB 742–1 ammunition lots, use DD Form 1575 (Suspended Tag—Materiel), DD Form 1576 (Test/Modification Tag—Materiel), or DD Form 1577 (Unserviceable (Condemned) Tag—Materiel) as required.

(3) Mark the forms to identify the reported item and the lot they go with. Keep them in order so they won't get lost or mixed up. If instructions to return the bad item(s) for checkout are received, mark the shipping paper and materiel like this: Exhibit for MIF#/DIF#. (For conventional ammunition, the tagged exhibits would be marked for Malfunction Investigation File or Deficiency Investigation File, not an ACR. Only MIF/DIF files (not ACRs) fund for investigations.

(4) If instructions are not provided within 90 days, dispose of the exhibit(s) in accordance with applicable SOPs, ARs, and DOD directives. If the exhibit cannot be kept, the activity to which the exhibit is sent must keep the exhibit.

(5) Package exhibits carefully for shipping to prevent any more damage.

(6) Take equipment apart to get exhibits only when that action is within the normal maintenance level.

### **8–4. DA Form 2415 (Ammunition Condition Report) (RCS CSGLD–1202)**

A DA Form 2415 provides management information on unserviceable, and permanently suspended ammunition items.

*a.* DA Form 2415 is used to report ammunition, and may be initiated as a result of but not limited to the following actions:

(1) Ammunition inspection: Periodic inspection, receipt inspection, safety-in-storage inspection, and special inspection.

(2) Permanent suspense assignment by owning service.

(3) As specifically requested by higher headquarters.

(4) DA Form 2415 submittal is also contingent on satisfying conditions as established by the appropriate command.

*b.* A DA Form 2415 is prepared as follows:

(1) For conventional ammunition items, submit all data through the following Web site: <https://www6.osc.army.mil/DemilMaint/MainMenu.asp>.

(2) For missile items, submit all data through the following Web site: <https://webdesk.redstone.army.mil>.

(3) Individual DA Form 2415 is made for each owner of assets being reported. Individual DA Forms are made for each line item reported. More than one lot number with the same NSN may be reported on the same ACR so long as associated NSN and ammunition lot number integrity are maintained.

(4) If a continuation sheet is needed to finish a report, a blank sheet of bond paper (8–1/2 by 11 inches) may be used. Each continuation sheet must be marked with the organizations name, ACR number, and date of report. This information is placed at the top of each page. Pages will be numbered "Page ## of ## Pages". For conventional ammunition items submitted through the Web site link above, attach a narrative, PDF files, and so on, using an e-mail attachments option.

(4) Instructions for correctly filling out a DA Form 2415 are contained in figure 8–1. (For conventional ammunition ACRs, see the Web site input instructions in the Help option on the ACR main menu.)

c. The Joint Munitions Command and U.S. Army Aviation and Missile Command provide disposition instructions by e-mail to the ACR originator within 90 days of their receipt ACR.

#### **8-5. ACR submission flow and preparation**

a. ACRs are not used to report—

(1) Packaging materiel (Federal Supply Class (FSC) 8140). See AR 700-22 and Ammunition Maintenance Component and Packaging Report, RCS CSGLD-1322 (RI).

(2) Ammunition malfunctions. See AR 75-1.

(3) Single managed ammunition items with expired shelf life and/or installed life should be reported via e-mail to the item manager at JMC-OFC-CDC@afsc.army.mil.

(4) Single managed ammunition items whose storage temperature limits have been exceeded or subjected to below standard conditions. Report by e-mail to JMC Surveillance at JMC-OFC-QAE@afsc.army.mil.

(5) Critical defectives. Lots containing critical defectives are locally suspended, assigned Condition Code J, and reported to the appropriate MSC by the most expeditious means.

(6) Temporarily suspended items. Report to the appropriate MSC by the most expeditious means.

(7) EIRs. SF 368 is used to report EIRs.

(8) Incorrect manuals, drawings, specifications, or detailed records of ammunition to components or explosives. DA Form 2028 should be used for this purpose.

(9) Serviceable, obsolete items no longer needed. Report to appropriate NICP by memorandum.

(10) Items being tested.

(11) Operational Stinger guided missiles without battery control units.

(12) Quality Deficiency Reports.

(13) Marine Corps ammunition placed in condition code H by specific Notice of Ammunition Reclassification. Such ammunition may be disposed of regardless of dollar value; however, on-hand quantities must be reported in accordance with TWO-24-AA-ORD-010.

(14) (For conventional Ammunition) Industrial and Production owned class V items.

(15) (For conventional ammunition) ACRs from wholesale storage sites on Army owned class V items.

b. All reports and ACRs should be sent through proper command channels.

c. Nonsingle managed ammunition items with expired shelf life, exceeded storage limits, or CADS and PADS should be reported as required to the appropriate NICP.

<b>AMMUNITION CONDITION REPORT</b>				<i>REQUIREMENT CONTROL SYMBOL</i>	
<small>For use of this form, see DA PAM 738-750; the proponent agency is DCSLOG</small>				<i>CSEGLD-1202</i>	
1. THRU: <i>(Include ZIP Code)</i>		2. DATE OF REPORT  22 DEC 01	3. PAGE <u>1</u> OF <u>1</u> PAGES		
4. TO: <i>(Include ZIP Code)</i> Commander, U.S. Joint Munitions Command (JMC) ATTN: SFSJM-MAS-D Rock Island, IL 61299-6000		5. UNIT IDENTIFICATION CODE  W1U7AA-6-01			
8. FROM: <i>(Include ZIP Code)</i> Commander, Blue Grass Army Depot ATTN: CDSC-MAC Richmond, KY 40475		7. COMMODITY <input type="checkbox"/> CHEM <input type="checkbox"/> GM <input checked="" type="checkbox"/> CONV			
8. NOMEN - MODEL ITEM REPORTED Projectile, 155 mm HE, M483A1	a. PART/NSN NO. 1320-00-126-7339-D563	b. SN/LOT NO. MA-95A003-042	c. DATE OF MFG Jan 00	d. QTY IN LOT 2,251	
9. NOMEN - MODEL EQUIP INSTALLED/USED ON	a. PART/NSN NO.	b. SN/LOT NO.	c. DATE OF MFG	d. QTY IN LOT	
10. QTY INSPECTED  20	11. QUANTITY DEFECTIVE  20	12. PRESENT COND CODE  F	13. ECON REPAIRABLE <input type="checkbox"/> YES <input type="checkbox"/> NO		
14. USE <input checked="" type="checkbox"/> WR <input type="checkbox"/> TNG	15. ESTIMATED REPAIR/MAINT/DISPOSAL UNIT COST DIRECT LABOR \$                      GAE \$                      OTHER \$				
16. DETAILS <i>(Description, cause, action, disposition)</i>					
a. Description:					
(1) Reason for ACR initiation: Defects noted during performance of periodic inspection.					
(2) Defects encountered: (SASIP 742-1320-94-250).					
(a) Outer pack: 10 percent pallet bases damaged (minor).					
(b) Inner pack: N/A					
(c) Item: 100 percent with diamond marking mission (major). 30 percent with corrosion on fuze well threads (major). 5 percent with loose give/body joint (major).					
(3) Owner/Account: Army/B14					
b. Cause: Corrosion defectives are deteriorative in nature. Other defectives are manufactured defects.					
c. Action: Lot retained in condition code F. ACR W1U7AA-2-00 previously submitted unserviceable, lot identified above in condition code F.					
d. Disposition:					
(1) Recommended renovation to Condition code A.					
(2) BGAD has the capability to perform recommended renovation.					
e. Originator: Mathew Spurlock, QASAS, DSN 683-2297.					
17. TYPED/PRINTED NAME, GRADE AND TITLE CONNIE CARLSON GS-346-13, Ammo Sur Division			18. SIGNATURE 		

DA FORM 2415, 1 DEC 77

EDITION OF 1 JAN 84 IS OBSOLETE.

USAPPC V1.00

Notes:

<sup>1</sup> When more space is needed, additional sheets may be used. All approving officials must show approvals or comments in this disposition position. The organization making the request and all thru addressees must use block 16 for title and signature of the approving office. Refer to SB 742-1 for a listing and explanation of standard defect codes used in reporting ammunition condition through the WARS.

<sup>2</sup> For conventional ammunition items, go to the following Web site: <https://www6.osc.army.mil/DemilMaint/MainMenu.asp>; see the help option on the ACR Main menu for instruction on how to fill out the ACR. Some of the information on DA Form 2415 is no longer required

Figure 8-1. Sample DA Form 2415

Legend for Figure 8-1;

completion instructions for missile items follow.

1. THRU: Enter the complete address as needed.
2. DATE OF REPORT. Enter date the report is finished. This date should be the same as the actual date it is sent.
3. PAGE \_\_\_ OF PAGE \_\_\_. Enter the page number:
4. TO: (Include ZIP Code). Commander U.S. Army Joint Munitions Command, ATTN: SFSJM-MAS-D, Rock Island, IL 61299-6000
  - a. For missile items, enter: Commander U.S. Army Aviation and Missile Command ATTN: AMSMI-MMC-LS-SM, Redstone Arsenal, AL 35898-5679
5. UNIT IDENTIFICATION CODE. Enter the UIC. List the ACR number after the UIC. For example, W1U7AA-6-01 shows the sixth ACR made in calendar year 2001 by unit W1U7AA.
6. FROM: (Include ZIP Code). Enter the organizational name and address. (Overseas units are APO addresses.)
7. COMMODITY. CHEM/GM/CONV. Enter an X in the block that describes the commodity.
8. NOMEN—MODEL ITEM REPORTED. Enter the name of the item reported. If the item is a component, enter the end item in block 9.
  - a. PART/NSN NO. Enter the complete NSN and Department of Defense Identification Code in the block. Use a part number if no NSN is assigned.
  - b. SN/LOT NO. Enter the lot/serial number of the item. If the lot number is unknown, use the vendors name or symbol.
  - c. DATE OF MFG. Enter the date the item was made.
  - d. QTY IN LOT. Enter the number of items in the lot/number of serial number being reported.
9. NOMEN—MODEL EQUIP INSTALLED/USED ON. List the name and model number of the USED end item if the item in block 8 is a component. If an end item is reported in block 8, no entry is needed in blocks 9 through 9d.
  - a. PART/NSN NO. Enter the complete end item NSN.
  - b. SN/LOT NO. Enter the end item lot/serial number.
  - c. DATE OF MFG. Enter the date the end item was made.
  - d. QTY IN LOT. Enter the number of end items in the lot/number of serial numbers being reported.
10. QTY INSPECTED. Enter the total number of items looked at, processed, or tested that made the item reportable in block 8.
11. QUANTITY DEFECTIVE. Enter the number of bad items found by the inspection.
12. PRESENT COND CODE. Enter the latest federal condition code of the item. See AR 725-50.
13. ECON REPAIRABLE. Leave blank. This is a HQDA determination item.
14. USE. Enter an X in the proper block.
15. ESTIMATED REPAIR/MAINT/DISPOSAL UNIT COST. Enter information if local capability exists. This is for HQ evaluation only.
16. DETAILS.
  - a. Description: Should include the following entries:
    - (1) Reason for ACR initiation: For example, defects noted during performance or periodic inspection.
    - (2) Defects encountered: That is, all defects (incidental, minor, major and critical) and frequency of defect occurrence (for example, 10 percent or 20 percent) should be noted and listed as appropriate. If needed, use photographs to help describe the item. Give part numbers, drawing numbers, and references (for example, TMs and TBs).
    - (3) Owner/Account: List appropriate owner and account of item being reported (for example, Navy/NCB; Army/B64; and so on).
  - b. Cause: If appropriate, should include a brief explanation regarding the reason assets are unserviceable (for example, defectives are deteriorative in nature; improper handling procedures; latent manufactured defect; and so forth).
  - c. Action: Should include a brief description of interim action taken locally, pending receipt of final disposition to ACR (for example, lot transferred from condition code A to condition code F; report of survey initiated). Also, if applicable, use the latest ACR submitted to report. The unit identification code control number is referenced for items that are the same. For example, ACR W390AA-02-01, previously reported unserviceable lot identified above in condition code F.
  - d. Disposition: Should include recommendation for disposition if within the local capacity. It should also be noted when the recommended action can be accomplished. Note: when more space is needed, additional sheets may be used. All approving officials must show approvals or comments in this disposition position. The organization making the request and all through addressees must use block 16 for title and signature of the approving office. Note: Refer to SB 742-1 for a listing and explanation of standard defect codes used in reporting ammunition condition through the Worldwide Ammunition Reporting System (WARS).
  - e. Originator: The originators name, job title, and DSN number should be listed as the final entry. Typed/Printed Name, Grade and Title. Enter the name, grade and title. Signature. Signature of the person approving release of the report.
17. TYPED/PRINTED NAME, GRADE, AND TITLE. Enter the name, grade, and title of the person performing the inspection.
18. SIGNATURE. Signature of the person who conducted the inspection and approves release of the report.

**Figure 8-1. Sample DA Form 2415**

---

## **Chapter 9 Supply and Maintenance Assessment and Review Team (SMART)**

### **9–1. General**

This chapter announces the Supply and Maintenance Assessment and Review Team (SMART) and provides general guidance on the objectives and procedures of the program.

*a.* The DCS, G–4 established SMART to examine, streamline, and improve unit-level logistics support, particularly within a division, and at direct support levels and below. SMART assumed management responsibility for the Tool Improvement Program Suggestions (TIPS) in August 1997. TIPS is an Army suggestion program that encourages users of Army tools to submit tool improvement ideas directly to the DCS, G–4 TIPS executive agent for evaluation. AR 5–17 contains regulatory guidance for the SMART and TIPS programs.

*b.* The U.S. Army Combined Arms Support Command (CASCOM), as the TRADOC executive agent for Project SMART/TIPS, examines initiatives received for the purpose of identifying, eliminating, or modifying unnecessary and complicating directives or procedures that create burdens on logistics operations/functions. Those ideas that result in cost savings to the Army are recommended for implementation or testing.

*c.* The success of Project SMART/TIPS is dependent upon—

- (1) Input from the field.
- (2) Command emphasis.

*(a)* Commanders should not attempt to filter out ideas that might not seem worthy for submission. Some of the best ideas have been simple, direct suggestions.

*(b)* Commanders should not demean the program through campaigns that focus on quantity. Quality ideas are most often unsolicited and spring from a desire to relieve a burden or correct an error rather than to meet a quota.

*d.* Project SMART/TIPS is open to all members of the U.S. Army, the Army National Guard, the U.S. Army Reserve, and Department of the Army civilians.

### **9–2. Procedures**

*a.* DA Form 5533 (SMART Suggestion Form) is the official form for submitting SMART initiatives directly to the CASCOM SMART office. However, use of DA Form 5533 is not a requirement. Initiatives may be submitted on plain paper or sent by e-mail to SMART@lee.army.mil. Web submissions may be made through the CASCOM Web site at [www.cascom.lee.army.mil](http://www.cascom.lee.army.mil) or <http://aeps.ria.army.mil/SMART/smartidea.cfm>. SMART ideas reside on the AEPS system.

*b.* Submissions should be specific in nature, and outline: who, what, where, why, how, and benefits to be gained if the initiative is adopted. It is also important that the individual submitting a suggestion include name, address, and telephone number. In many instances, it is necessary to call or write the individual in order to discuss or clarify the idea. When SMART ideas are approved for adoption, the individual who submitted the idea receives proper credit/recognition.

*c.* Initiatives should be sent to Project SMART/TIPS, 3901 A Avenue, Suite 220, Fort Lee, VA 23801–1809.

*d.* All SMART/TIPS initiatives are acknowledged.

*e.* Selected ideas adopted through SMART/TIPS are implemented in accordance with the procedures outlined by the proponent doing the evaluation.

## **Chapter 10 Submitting Equipment Improvement Reports and Product Quality Deficiency Reports and Reporting Initial Failure of Stock-Funded, Depot-Level Repairables**

This chapter provides procedures for submitting EIRs, PDQRs, and initial failure of SFDLRs.

### **10–1. Reporting**

Anyone finding quality deficiencies in Government-owned materiel is required by this pamphlet, DA Pamphlet 738–751, and AR 702–7 (DLAD/DLAI 4455.24) to report the defects to the appropriate Military Service Screening Point for investigation and resolution. For situations where equipment becomes dangerous to people, Ground Precautionary Messages and Safety of Use Messages should be issued in accordance with AR 750–6. Submit an SF 368 via Electronic Deficiency Reporting System (<https://aeps.ria.army.mil>), mail, e-mail, or fax to the military service/agency screening point for that item (see table 10–1).

*a.* SF 368 is a multiuse form for reporting—

- (1) Product quality deficiencies in repair parts, components, assemblies, weapon systems, equipment, and software.

- (2) Deficiencies due to design, manufacturing, depot level overhaul, or maintenance.
- (3) Suggested ideas or recommendations for improvements to equipment.
- b. The SF 368 is used to specifically report—
  - (1) A condition with equipment that is dangerous to people, other equipment, or missions.
  - (2) An item or equipment that does not work right or last as long as it should because of bad design or materials.
  - (3) Items that are not within the size, material hardness, finish, or performance limits of the approved equipment specifications.
  - (4) Low-quality workmanship.
  - (5) Dangerous situations because of incorrect or missing data.
  - (6) Maintenance problems.
  - (7) Conditions that prevent use of the equipment.
  - (8) Repeated problems that take a lot of time and a solution is not in sight.
  - (9) Any problems with equipment repaired or overhauled through the NMP. Special attention should be paid to identify the NMP facility by checking the data plate, which must then be entered on the SF 368.
  - (10) Corrosion problems in or on parts, components, assemblies, weapon systems, and equipment.
- c. Fill out an SF 368 to—
  - (1) Get disposition instructions for credit, replacement, or repair of defective items (figs 10–1 and 10–2).
  - (2) Stop repeat shipments of defective items.
  - (3) Get corrective action.
  - (4) Improve the performance and maintenance of the equipment.
  - (5) Identify problems, trends, and recurring deficiencies.
- d. Do not use the SF 368 to report—
  - (1) Items purchased or repaired locally (such as an SRA).
  - (2) Security assistance items after the foreign government has received them (see AR 12–12).
  - (3) Medical materiel (see AR 702–7).
  - (4) Subsistence materiel (see AR 40–660).
  - (5) Preservation, packaging, packing, or marking errors (see AR 735–11–2).
  - (6) Shipping type errors such as overages, shortages, wrong item received, or expired shelf life. Report those problems on the SF 364 (Report of Discrepancy (ROD)) (see AR 735–11–2).
  - (7) Transportation type errors such as shortages, loss, or damage during transportation.
  - (8) Materiel that fails because of inadequate user maintenance (including operator and DS/GS maintenance), improper operation, and normal wear and tear.
  - (9) Malfunctions involving ammunition and explosives (see AR 75–1).
- e. DA Pam 738–751 prescribes the use of the SF 368 for aviation equipment: aircraft, aviation managed ground support equipment, and aviation life support equipment.

## 10–2. Use and preparation of an SF 368

This paragraph provides instruction for reporting quality deficiencies and recommendations for improving equipment using either the AEPS Web site or applicable electronic Web site, SF 368, message, or electronic mail.

*Note.*

New procedures have been added at paragraph 10–5 to improve the control of exhibits and issuing of credit for SFDLR that fail on initial use.

a. The person who discovers a defect or has an equipment improvement recommendation is responsible for reporting it on an SF 368. Prepare the SF 368 as completely as possible. Do not delay sending the form because of missing information or local staffing.

b. Product quality defects and equipment improvement recommendations fall into the following two categories:

(1) *Category I.*

(a) *Explanation.* A defect that may cause death, injury, or severe job illness; would cause loss or major damage to a weapon system; or critically restricts the combat readiness capabilities of the unit. Improvement recommendations that prevent death, injury, or severe job illness; prevent loss or major damage to a weapon system, or would affect the combat readiness of the unit are also Category I.

(b) *Processing.* Prepare and forward a Category I report via the Electronic Deficiency Reporting System (<https://aeps.ria.army.mil/aepspublic.cfm>), email or fax within 48 hours after the defect or problem is found. If needed information does not apply to the problems being reported, enter “N/A” in the appropriate block. Category I reports may be phoned in or brought in for immediate assistance, but must be followed by an electronic copy or fax within the 48-hour time frame. The MSC must acknowledge receipt within 24 hours of receipt of the report.

(2) *Category II.*

(a) *Explanation.* Any defect or recommendation that does not meet the criteria of a Category I.

(b) *Processing.* Prepare and forward the original SF 368 to the proper MSC in table 10–1 within 5 working days after the defect or problem is found. The report or recommendation may be sent by the SF 368 format of figure 10–1, the message format of figure 10–3, or by electronic mail using the SF 368 electronic facsimile.

**Table 10–1**  
**Army screening points**

RIC	Activity address/message address	Phone	E-mail	DODAAC/MATCAT 1st position
B14	U.S. Army RDECOM-ARDEC Rock Island, IL 61299-7300 CDRRDECOM-ARDEC ROCK ISLAND IL// AMSRD-AAR-QEP-C//	Voice (309) 782-7698 DSN 793-7698 FAX (309) 782-6653 DSN 793-6653	qawqdrs@ria.army.mil	W91AS2/D, M
AKZ A12	U.S. Army Tank-automotive and Arma- ments Command ATTN: AMSRD-TAR-E/ PQDR Warren, MI 48397-5000 CDR TACOM WARREN MI//AMSRD- TAR-E/PQDR//	Voice (586) 574-5422 DSN 786-5422 FAX (586) 574-5666 DSN 786-5666	tacomdrs@tacom.army.mil	W81D19/K
B16 B46 B56	U.S. Army Communications Electronics Command ATTN: AMSEL-LC-LEO-D-CS- CFO// Ft. Monmouth, NJ 07703-5000 CDRCECOM FT MONMOUTH NJ//AM- SEL-LC-LEO-D-CS-CFO//	Voice (732) 532-4839 DSN 992-4839 FAX (732) 532-1413 DSN 992-1413	cfo@cecom2.Monmouth.army.mil	W15GK9/G, P, Q, V
B17 B64	U.S. Army Aviation and Missile Command ATTN: AMSAM-MMC-MA-NM Redstone Arsenal, AL 35898-5000 CDR AMCOM REDSTONE ARSENAL AL//AMSAM-MMC-MA-NM//	Voice (256) 842-6665 DSN 788-6665 FAX (256) 876-4904 DSN 788-4904	cfo@redstone.army.mil	W81D17/H, L
B14	U.S. Army JMC ATTN: SFSJM-QAP Rock Island, IL 61299-6000 CDR JMC ROCK ISLAND IL//SFSJM- QAP//	Voice: (309) 782-6466 DSN 793-6466 FAX (309) 782-7341 DSN 793-7341	Margaret.Johnson1@us.army.mil	W52P1J

Notes:

<sup>1</sup> Report Product Quality Deficiencies to the Army using the AEPS Web site: <http://aeps.ria.army.mil/> for the submittal of QDRs on all Army materiel. Army screening point addresses and information are provided as supplemental information. If assistance is needed in submitting the QDR in AEPS, contact any phone number above.

<sup>2</sup> Deficiencies in ammunition (other than malfunctions) shall be sent to B14, U.S. Army Joint Munitions Command as listed above.

c. Handling procedures are as follows:

(1) *Special handling procedures for software.* If it is known that the problem is associated with software, complete the SF 368 per the preparation instructions for figure 10–3.

(2) *Telephone numbers and mailing addresses for the SF 368 (table 10–1).* The MSC is identified by the MATCAT as shown below:

(a) The MATCAT can be found by looking up the national item identification number (the NSN without the first four numbers) on the AMDF. The MATCAT is a five-position code on the Federal Logistics Record (FED LOG). Table 10–1 break out the responsible MSC by the first position code of the MATCAT.

(b) For computer software deficiencies, use the MATCAT or the FSC for the equipment on which the software is loaded.

(3) *Copies.*

(a) Keep one copy of the SF 368 until the Army screening point closes the case. Retention of the document beyond that date for historical records and eventual disposition of the hard copy should be at the discretion of the originating activity.

(b) Send one copy of the SF 368 to the support maintenance activity. If required locally, also send a copy of the SF 368 responses to the maintenance support unit.

d. The SF 368 is not to be returned to the sender or delayed simply because it is not clean or contains spelling, grammar, or punctuation errors.

e. SF 368 is to be sent in even though—

(1) Other units in the command sent in an SF 368 on the same subject or problem.



(2) DA or the manufacturer, command, or correspondence indicates that they already know about the subject or problem. Note. Equipment improvement recommendations are not needed when the corrective action is printed in the Equipment Improvement Report and Maintenance Digest (TB 43-0001 series).

f. If an SF 368 is submitted to recommend an improvement to equipment, consider submitting the idea as a suggestion (see AR 672-20).

g. SF 368s are available on the Web (see appendix A).

### 10-3. Exhibits

a. When SF 368 is used to report a deficiency, the item being reported is required to be held by the user. These items or samples of items are known as exhibits and are used to support investigation of the defect by the MSC responsible for the class of materiel.

b. Exhibits must not be taken apart at unit or support maintenance levels just to see what caused the problem. If the condition is found during authorized disassembly, the exhibit is reassembled in the original condition. Everything considered a part of or contributing to the failure should be kept for investigation, analysis, and support of the SF 368. When contaminated fluids are drained for preservation, include a sample with the exhibit.

*Note.* In all cases, block 22 or 23 of the SF 368 identifies the exhibit holding point, the name of a point of contact, e-mail address, and both commercial and DSN phone numbers.

c. Retention of exhibits is as follows:

(1) Each exhibit is tagged with DD Form 1575 (fig 10-5) and DD Form 2332 (fig 10-4) and classified in a suspended supply condition code L.

(2) The originator of the SF 368s keeps each exhibit for at least 60 days or until disposition instructions are received from the responsible MSC. If after 60 days, shipping or disposition instructions have not been received, a followup may be conducted with the appropriate MSC.

(3) Exhibits are secured and/or segregated from all other materiel.

d. Shipping of exhibits is as follows:

(1) When an exhibit is required for investigation, the request will be forwarded from the action officer assigned to the QDR.

(2) The tagged exhibits, along with a copy of the SF 368 report, are adequately packaged, including necessary bracing and cushioning, to ensure safe delivery to the destination. AR 700-15 may be used for exhibit packaging and marking guidance. The outside of the package is clearly marked, To Be Opened In The Presence of a Government Representative and is also marked, PQDR Exhibit/Report Control Number XXX.

(3) Category I PQDR exhibits are shipped priority designator (PD) 03 within 3 days after notification; Category II PQDR exhibits will be shipped PD 06 within 6 days after notification. If specific shipping priority instructions are not provided for an exhibit to be returned after completion of the investigation, then PD 09 will be used.

(4) Notify appropriate major subordinate command of shipment of exhibits.

e. Disposition of exhibits is as follows:

(1) If disposition orders are not received within 60 days from the date on the SF 368 submission, and initiating activity followups prove unsuccessful in attaining disposition, dispose of the exhibit using current supply procedures. If it is known that disposition orders are coming, keep the exhibit until the orders are received. When normal supply procedures are used to dispose of the equipment, ensure that the condition code has been changed from a suspended condition code to a reclassified condition code as shown in AR 725-50, table C-38 and C-39.

(2) Disposition instructions from the MSC show the assigned SF 368 report control number. The orders also give accountability and disposition information. To keep track of the exhibit during processing, the SF 368 report control number goes on all property and shipping papers.

### 10-4. Addresses for the SF 368

a. Use the AEPS Web site or applicable Web site whenever possible to send category I messages.

b. If AEPS access is not available, send Category I messages and SF 368s to the Army screening points listed in table 10-1. These addresses are the screening points where all SF 368s are to be sent, regardless of who furnished the item. The screening point is identified in Position 1 of the MATCAT in the FED LOG for each Army NSN. If the NSN cannot be found in the FED LOG, contact the responsible MSC as identified by the equipment technical manual.

c. These addresses supersede any forwarding addresses for SF 368s in equipment manuals.

### 10-5. Reporting initial failure of SFDLR

This paragraph provides instructions for reporting initial failures of SFDLR.

a. *Explanation.*

(1) *Initial failure.* An initial failure occurs if the first time an SFDLR is used it does not work and the failure is not caused by accident, misuse, improper operation, improper installation, unauthorized repair, or alteration. Full 100 percent credit is authorized if the initial failure is validated.

(2) *SFDLR*. An *SFDLR* is an item with an MRC of D or L or an item having both a MRC of O, F, or H and an Automatic Return Code of C, E, R, or S.

*b. Processing.*

- (1) Do not tamper with the item; this would result in the loss of initial failure credit.
- (2) Reclassify defective materiel (PQDR exhibit) into a suspended supply condition code.
- (3) Tag suspended materiel with DD Form 1575 and DD Form 2332.
- (4) The outside of the package shall be clearly marked on one side "PQDR EXHIBIT/Report Control Number \_\_\_\_\_." Mark two other sides of the outside of the package in bold letters "PQDR EXHIBIT."
- (5) Segregate defective materiel from serviceable materiel to prevent issue.
- (6) Prepare the PQDR SF 368 and explain completely what happened in block 22. Provide the original requisition number. If the requisition number is not available, the user/originator must identify the DODAAC and fund code to which credit is to be granted. No credit can be granted without this documentation.
- (7) Contact the local AMC LAO and request that the appropriate MSC logistics assistance representative (LAR) confirm that an initial failure exists.
- (8) The LAR looks up the NSN of the failed item and assures that it is a *SFDLR*.
- (9) The LAR determines if the claim meets the established criteria for initial failures. If the item qualifies as an initial failure, the LAR annotates the PQDR, in block 22, with the following: INITIAL FAILURE - YES, the LAR's signature, telephone number, and date. If the PQDR is submitted online, the LAR may also validate it online.
- (10) If the item doesn't meet the criteria for an initial failure, follow the normal SF 368 process.
- (11) After confirming and signing the hardcopy PQDR, the LAR either returns the PQDR to the originator for submission to the appropriate screening point or submits the PQDR by e-mail to the correct MSC screening point.

PRODUCT QUALITY DEFICIENCY REPORT					
1a. FROM (Originator) HQ, 105 Support Battalion Fort Knox, KY 40121 DODAAC: WK4FFF			2a. TO (Screening point) Commander, U.S. Army ATTN: AMSRD-TR-E/P Warren, MI 48397-5000		
1b. NAME, TELEPHONE NO. AND SIGNATURE Marvin Hall DSN 687-1235		1c. DATE 31 JUL 04	2b. NAME, TELEPHONE NO. AND SIGNATURE		
3. REPORT CONTROL NO. WKFFF000001	4. DATE DEFICIENCY DISCOVERED 31 JUL 04	5. NATIONAL STOCK NO. (NSN) 2835-01-222-7936	6. NOMENCLATURE		
7a. MANUFACTURER/CITY/STATE AVCO-LYCOMING CORPORATION COLUMBUS, OH		7b. MFRS. CODE FKC-43	7c. SHIPPER/CITY/STATE AVCO-LYCOMING, CO		
9. SERIAL/LOT/BATCH NO. 403-221	10a. CONTRACT NO. DAAF-07-V-88-KX	10b. PURCHASE ORDER NO.	10c. REQUISITION NO. W22P		
11. ITEM <input type="checkbox"/> NEW <input checked="" type="checkbox"/> REPAIRED/ OVERHAULED		12. DATE RECD., MFRD. RE- PAIRED, OR OVERHAULED UNK	13. OPERATING TIME AT FAILURE 10		
15. QUANTITY		a. RECEIVED 6	b. INSPECTED 6	c. D	
16. DEFICIENT ITEM  WORKS ON/WITH	a. END ITEM (Aircraft, mower, etc.)	(1) TYPE/MODEL/SERIES M1A1 TANK			
	b. NEXT HIGHER ASSEMBLY	(1) NATIONAL STOCK NO. (NSN) 2350-01-087-1095	(2) NOMENCLATURE TANK, M1A1		
17. UNIT COST \$		18. ESTIMATED REPAIR COST \$		19a. ITEM UNDER WARRANTY <input type="checkbox"/> YES <input type="checkbox"/> NO <input checked="" type="checkbox"/> UN- KNOWN	
20. WORK UNIT CODE/EIC (Navy and Air Force Only.)					
21. ACTION/DISPOSITION <input checked="" type="checkbox"/> HOLDING EXHIBIT FOR 60 DAYS <input type="checkbox"/> RELEASED FOR INVESTIGATION <input type="checkbox"/> RETURNED TO STOCK <input type="checkbox"/> DISPOS OF					
22. DETAILS (Describe, to best ability, what is wrong, how and why, circumstances prior to difficulty, description of disposition, recommendations. Attach copies of supporting documents. Continue on separate sheet if needed.)					
a. Utilization code: 0 b. Failure detected during: normal operation of vehicle c. First indication of trouble: Stopped working d. TM 9-2350-261-34P e. Circumstances prior to difficulty: Normal use in cross country travel f. Description of difficulty: Fwd module has failed in 1 of 6 vehicles on hand. The failure occurred during normal use. g. Cause: Unknown h. Action Taken: Inspected module, no visible sign of catastrophic damage. i. Recommendations: None j. INITIAL FAILURE k. Category I: N l. Initial Failure: m. Turn-in document					
23. LOCATION OF DEFICIENT MATERIAL HQ, 105TH Support Battalion, BLDG 5408, Fort Knox, KY 40121					
24a. TO (Action Point)			25a. TO (Support Point) (Use		
24b. NAME, TELEPHONE NO. AND SIGNATURE		24c. DATE	25b. NAME, TELEPHONE NO. AND SIGNATURE		
26a. TO (Support Point)			27a. TO (Support Point)		
26b. NAME, TELEPHONE NO. AND SIGNATURE		26c. DATE	27b. NAME, TELEPHONE NO. AND SIGNATURE		

368-102  
NSN 7540-00-13305541

Notes:

<sup>1</sup> Sketches and pictures should be attached as needed to help explain the condition or equipment improvement.

Legend for Figure 10-1;

completion instructions follow.

Figure 10-1. Sample SF 368 used to report equipment deficiencies

CATEGORY I/II. Mark the Category II box (All Category I deficiency reports must be sent in by message). Provide as much of the following information as possible. Much of the data can be found below the bar code symbol located on the item or package. Submit the report even if all data are not available.

- 1a. FROM (*Originator*). In addition to your unit, location, and ZIP Code or APO number, enter your Department of Defense Activity Address Code (DODAAC).
- 1b. NAME, TELEPHONE NO. AND SIGNATURE. Type or print your name and duty phone (include DSN and Commercial numbers).
- 1c. DATE. Type or print current calendar date; for example, 20 Jan 97.
- 2a. TO (*Screening point*). Enter the command and address from table 10-1.
- 2b. NAME, TELEPHONE NO. AND SIGNATURE. Leave blank.
- 2c. DATE. Leave blank.
3. REPORT CONTROL NUMBER. Enter the DODAAC of your unit (6 places) followed by the calendar year (2 places). Then give the number of SF 368s submitted during the calendar year (4 places). For example, the first SF 368 for 1997 sent in by a unit with DODAAC WK4FFF would be WK4FFF970001.
4. DATE DEFICIENCY DISCOVERED. Enter the calendar date the deficiency was discovered; for example, 20 Jan 97.
5. NATIONAL STOCK NO. (NSN). Enter the NSN of the bad item.
6. NOMENCLATURE. Enter the name of the bad component/item.
- 7a. MANUFACTURER/CITY/STATE. Enter the name of the manufacturer, contractor, or government unit that made or repaired the bad item, if known, as well as the city and state.
- 7b. MFRS. CODE. Enter the code of the manufacturer, contractor, or government unit that made or repaired the bad item.
- 7c. SHIPPER/CITY/STATE. Enter the name of the shipper, as well as the city and state.
8. MFRS. PART NO. Enter the manufacturers part number, if available. (Leave blank if an NSN is in block 5.)
9. SERIAL/LOT/BATCH NO. If known, enter in a serial, lot, or batch number of the bad item(s). Lot numbers are used for ammunition items since serial numbers do not apply.
- 10a. CONTRACT NO. Enter the contract number.
- 10b. PURCHASE ORDER NO. Enter the purchase order number.
- 10c. REQUISITION NO. Enter the requisition number.
- 10d. GBL NO. Enter the GBL number.
11. ITEM: NEW OR REPAIRED/OVERHAULED. Check the proper block if the item is new or has been overhauled.
12. DATE RECD, MFRD, REPAIRED, OR OVERHAULED. Give the date received, manufactured, repaired, or last overhaul date, if known.
13. OPERATING TIME AT FAILURE. Discuss how long the equipment had been run when the problem was found. That is, how many miles, cycles, hours, or EFC rounds were on the equipment or component. For vehicles bought by the General Services Administration (GSA), enter the date the vehicle was first used.
14. GOVERNMENT FURNISHED MATERIAL. Mark the NO box. Only contractors mark the YES box.
15. QUANTITY. In the 4 blocks under quantity, enter the actual number of each item, not the unit of issue. That is, give the actual number of items being reported, no matter what the unit of issue is.
  - a. RECEIVED. Enter the total number of items in the lot or batch in which the defect was found, if known.
  - b. INSPECTED. Enter the number of items looked at.
  - c. DEFICIENT. Enter the number of items found to be bad after the inspection.
  - d. IN STOCK. Enter the number of the items in stock, if known.
16. DEFICIENT ITEM WORKS ON/WITH.
  - a. END ITEM (*Aircraft, mower, etc.*).
    - (1) TYPE/MODEL/SERIES. Show type/model/series of the end item or commodity that the bad item is used with or on (for example, M16A1 Rifle or 105mm Howitzer M102). Also list the NSN.
    - (2) SERIAL NO. Show the serial number of the end item when the item listed in block 5 is part of an end item.
  - b. NEXT HIGHER ASSEMBLY. If the bad item is part of a next higher assembly (NHA), enter the NHA:
    - (1) NATIONAL STOCK NO. (NSN). Enter the NSN.
    - (2) NOMENCLATURE. Enter the nomenclature.
    - (3) PART NO. Enter the part number.
    - (4) SERIAL NO. Enter the serial number. Lot numbers are used for ammunition items (serial numbers do not apply).
17. UNIT COST. Enter the dollar value of the bad item, if known. Use the AMDF price and list the unit price of one item.
18. ESTIMATED REPAIR COST. Enter the estimated cost (including overhead) to fix all of the bad items, if known. The cost can be found by multiplying the cost to fix one bad item by the number of bad items.
- 19a. ITEM UNDER WARRANTY. Check the proper box.
- 19b. EXPIRATION DATE. Enter the expiration date of the warranty.
20. WORK UNIT CODE/EIC. Enter the code for the maintenance unit doing the maintenance: O—Unit, F—Direct Support (DS), H—General Support (GS), D—Depot, L—Special Repair Activity.
21. ACTION/DISPOSITION. Check one of the blocks to show the type of the action taken or asked for. If an exhibit is held, show the number of days it is held (at least 55). If none of the items show the action taken or asked for, check other. Then show the type of action taken or asked for in item 22.

**Figure 10-1. Sample SF 368 used to report equipment deficiencies**

22. DETAILS. Enter the following information. If more space is needed, use a continuation sheet. Be sure to enter the Report Control Number (block 3) on the continuation sheet.

Utilization Code. Enter the proper utilization code. See table B-6. For vehicles in administrative use, use code V.

Failure detected during. Show when the failure was found. That is, during scheduled maintenance, test, storage, normal operation, inspection, or handling.

First indication of trouble. Tell about the conditions present when the first sign of trouble was noticed—that is, stopped working, got too hot or noisy, lost adjustment, did not perform as needed, didn't hold frequency, and so on.

TM number. To help identify the item, list the TM number, date, and latest change number. Also list the TM page, figure, and item number.

Circumstances prior to difficulty. Enter all the details of what was happening before the equipment failed. These details help the investigator. Be sure to tell about any modifications directly related to the problem. Any other information that might help the investigator should also be given here.

Description of difficulty. Write a brief, but thorough description of the problem or need.

Cause. Outline the most likely cause of the problem or need for improvement.

Action taken. Give a short summary of what was done to correct the problem or improve the equipment. If an item is fixed and put back in service, describe the repair, or if available, give pictures or drawings. List exhibit information: exhibit held, destroyed, or turned in to supply.

Recommendations. Give any suggestions to help stop problems, improve the equipment, or change instructions. NOTE: The following information is provided for Initial Failures of SFDLR:

Initial SFDLR. If the failed item is an initial SFDLR, the person who discovers the defect writes INITIAL FAILURE CLAIM. Otherwise, write SUBSEQUENT or FINAL FAILURE CLAIM.

Category I. If the PQDR/EIR is a category I, include the date/time group of the message; otherwise, leave blank.

Initial failure. If the LAR agrees that the failed item is an initial failure, the LAR writes, INITIAL FAILURE—YES, then signs and dates the form immediately following these words on the same line..

Turn in document. Include the final turn-in document number from your supporting SSA (DOD Single Line item release/receipt document).

23. LOCATION OF DEFICIENT MATERIEL. Enter the unit, name, location, and ZIP Code or APO number where the deficient materiel is located.

24a-27b. To be completed by the USAMC screening point.

---

**Figure 10-1. Sample SF 368 used to report equipment deficiencies**

---

PRODUCT QUALITY DEFICIENCY REPORT										<input type="checkbox"/> CAT
1a. FROM (Originator) HQ, 1/203D ADA (PATRIOT) Athens, AL 35613-3798 DODAAC: W30ABC					2a. TO (Screening point) Commander, U.S. Army Aviation ATTN: AMSAM-NMC-RE-FD Redstone Arsenal, AL 35898-50					
1b. NAME, TELEPHONE NO. AND SIGNATURE SPC John Goodperson DSN 645-9375				1c. DATE 20 JAN 03		2b. NAME, TELEPHONE NO. AND SIGNATURE				
3. REPORT CONTROL NO. W30ABC20200001			4. DATE DEFICIENCY DISCOVERED 20 JAN 03		5. NATIONAL STOCK NO. (NSN)		6. NOMENCLATURE PDB2			
7a. MANUFACTURER/CITY/STATE				7b. MFRS. CODE		7c. SHIPPER/CITY/STATE				
9. SERIAL/LOT/BATCH NO. BI.DG 5307			10a. CONTRACT NO.		10b. PURCHASE ORDER NO.		10c. REQUISITION NO.			
11. ITEM <input type="checkbox"/> NEW <input type="checkbox"/> REPAIRED/OVERHAULED			12. DATE RECD., MFRD. RE-PAIRED, OR OVERHAULED			13. OPERATING TIME AT FAILURE		14. GOVT. ACQUISITION <input type="checkbox"/> Y <input type="checkbox"/> N		
15. QUANTITY			a. RECEIVED		b. INSPECTED		c. DEFICIENT			
16. DEFICIENT ITEM WORKS ON/WITH		a. END ITEM (Aircraft, mower, etc.)	(1) TYPE/MODEL/SERIES PATRIOT Missile System Radar Set, AN-MPQ-53							
		b. NEXT HIGHER ASSEMBLY	(1) NATIONAL STOCK NO. (NSN)		(2) NOMENCLATURE		(3) PART			
17. UNIT COST \$			18. ESTIMATED REPAIR COST \$			19a. ITEM UNDER WARRANTY <input type="checkbox"/> YES <input type="checkbox"/> NO <input type="checkbox"/> UN-KNOWN		19b. EXPIRES		
20. WORK UNIT CODE/EIC (Navy and Air Force Only.)										
21. ACTION/DISPOSITION <input type="checkbox"/> HOLDING EXHIBIT FOR _____ DAYS <input type="checkbox"/> RELEASED FOR INVESTIGATION <input type="checkbox"/> RETURNED TO STOCK <input type="checkbox"/> DISPOSED OF										
22. DETAILS (Describe, to best ability, what is wrong, how and why, circumstances prior to difficulty, description of difficulty, disposition, recommendations. Attach copies of supporting documents. Continue on separate sheet if necessary.) a. Failure detected during. Maintenance b. First indication of trouble. Software error. c. Circumstances prior to difficulty. When running utilization code zero, the interrupt option 17 in the selected. d. Description of difficulty. Computer went into an endless loop looking for the line printer. e. Cause. Unknown f. Action Taken. System was rebooted to break the loop. g. Recommendation. Insert an error routine for a line printer. If a line printer is not detected, display back to the mode selection.										
23. LOCATION OF DEFICIENT MATERIAL HQ, 1/203D ADA (PATRIOT), Athens, AL 35613-3798										
24a. TO (Action Point)					25a. TO (Support Point) (Use Items 26)					
24b. NAME, TELEPHONE NO. AND SIGNATURE				24c. DATE		25b. NAME, TELEPHONE NO. AND SIGNATURE				
26a. TO (Support Point)					27a. TO (Support Point)					
26b. NAME, TELEPHONE NO. AND SIGNATURE				26c. DATE		27b. NAME, TELEPHONE NO. AND SIGNATURE				

368-102  
NSN 7540-00-13305541

Notes:

<sup>1</sup> Sketches and pictures should be attached as needed to explain the condition or equipment improvement, especially when exhibits are not available.

<sup>2</sup> Blocks not described in the completion instructions may be left blank.

Legend for Figure 10-2;

completion instructions follow.

1. CATEGORY I/II. Mark the Category II box (all Category I deficiency reports must be sent in by AEPS Web site or message).

Figure 10-2. Sample SF 368 used to report computer software deficiencies

- 1a. FROM (*Originator*). In addition to your unit, location, and ZIP Code or APO number, enter your Department of Defense Activity Address Code (DODAAC).
- 1b. NAME, TELEPHONE NO. AND SIGNATURE. Type or print your name and duty phone (include DSN and commercial numbers).
- 1c. DATE. Type or print current calendar date; for example, 20 Jan 97.
- 2a. TO (*Screening point*). Enter the command and address from table 10–1. Use the MATCAT or FSC for the equipment used with the computer software.
- 2b. NAME, TELEPHONE NO. AND SIGNATURE. Leave blank.
- 2c. DATE. Leave blank.
3. REPORT CONTROL NO. Enter the DODAAC of your unit (6 places) followed by the calendar year (2 places). Then give the number of SF 368s submitted during the calendar year (4 places). For example, the first SF 368 for 1997 sent in by a unit with DODAAC WK4FFF would be WK4FFF970001.
4. DATE DEFICIENCY DISCOVERED. Enter the calendar date, for example 10 Oct 92.
5. NATIONAL STOCK NO. (NSN). Enter the NSN of the bad item if one is known.
6. NOMENCLATURE. Enter the name of the computer software if available; for example, PDB2 initialization software.
9. SERIAL/LOT/BATCH NO. Enter the building number of the software being used.
16. DEFICIENT ITEM WORKS ON/WITH.
- a. END ITEM (*Aircraft, mower, etc.*). Show type of end item and the model/series of the hardware that the computer software is used on (for example, PATRIOT missile system, ECS).
- b. INSPECTED. Leave blank. (this should read next higher assembly—query author)
22. DETAILS. Enter the following information. If more space is needed, use a continuation sheet. Be sure to enter the Report Control Number (block 3) on the continuation sheet.
- Failure detected during. Show when the failure was found—that is, during scheduled maintenance, test, storage, normal operation, inspection, or handling.
- First indication of trouble. Tell about the conditions present when the first sign of trouble was noticed—that is, stopped working, did not perform as needed, false targets, and so on.
- Circumstances prior to difficulty. Enter all the details of what was happening before the trouble started. Include the hardware configuration/set up. These details help the investigator. Be sure to tell about any modifications directly related to the problem. Any other information that might help the investigator should also be given here. Attach hard copy printout or other information when possible. Classified information may be kept by originators as exhibits. No classified information may be entered on the SF 368 or mailed with it.
- Description of difficulty. Write a thorough description of the problem including the effects on the user, mission, or equipment.
- Cause. Outline the most likely cause of the problem or need for improvement.
- Action taken. Give a short summary of what was done to correct the problem. List exhibit information, that is, exhibit held, destroyed, or turned into supply.
- Recommendations. Give any suggestions to help prevent future problems, improve the equipment, or change instructions.
23. Location of deficient materiel. Enter the unit name, location, and ZIP Code or APO number where the deficient materiel is located.
- 24a-27b. To be completed by the USAMC screening point.

**Figure 10–2. Sample SF 368 used to report computer software deficiencies**

---

---

UNCLASSIFIED

01 01 130913Z NOV 01 PP PP UUUU ZYUW

NO

FM: CO A TRP B/1ARMCAV FT KNOX KY//

TO: CDRAMCOM REDSTONE ARSENAL AL//AMSAM-MMC-RE-FD//

INFO CDRAMC ALEXANDRIA VA//AMCQA-P//

UNCLAS

SUBJECT: CATEGORY I EIR - HYDRAULIC CONTROL PUMP

1. POINT OF CONTACT FOR ADDITIONAL INFORMATION IS CPT RAY BOSS, DSN  
464-4321, WK4FFF

2. N/A

3. WK4FFF010001

4. 13 NOV 01

5. 1650-00-295-4672

6. IMPELLER PUMP HYDRAULIC

7. A. XYZ CORP, RICHMOND VA

B. CXZ-497

C. ZYX CORPORATION, RICHMOND, VA

8. N/A

9. 693-486

10. A. DAAD-05-C-69

B. UNK

JOHNNY SMITH, SFC  
AQTR-DA, (502) 764-8890

RAY BOSS, CPT, AQTA-DA  
CRC:

UNCLASSIFIED

130913ZNOV01

Figure 10-3. Sample Category I SF 368 message format

---



---

UNCLASSIFIED

01 01 130913Z NOV 01 PP PP UUUU ZYUW

NO

C. W220PLM10010302

D. UNK

11. OVERHAULED

12. UNK

13. 459 HRS

14. YES

15. TWO (2)

A. TWO (2)

B. TWO (2)

C. ONE (1)

D. TWO (2)

16. A. EI

(1) TANK, M60, NSN 2350-00-116-9765

(2) UNK

B. NHA

(1) 3110-00-647-5303

(2) PUMP, HYDRAULIC CONTROL

(3) N/A

(4) N/A

JOHNNY SMITH, SFC  
AQTR-DA, (502) 764-8890

RAY BOSS, CPT, AQTA-DA  
CRC:

UNCLASSIFIED

130913ZNOV01

---

Figure 10-3. Sample Category I SF 368 message format

---

---

UNCLASSIFIED

01 01 130913Z NOV 01 PP PP UUUU ZYUW  
NO  
17. 850  
18. UNK  
19. UNK  
20. F  
21. 55  
22. A. 0  
B. INSPECTION  
C. NOISY  
D. TM 9-2320-228-24P, 26 JAN 71, PG 136, FIG 62  
E. NORMAL USE  
F. N/A  
G. IMPELLER SEPARATED DURING ENGINE RUN UP  
H. UNK  
I. REPLACED PUMP. EXHIBITS WILL BE HELD. SF 368 WILL BE  
SUBMITTED WITH PHOTOS.  
J. NONE  
23. CO A TRP 8/1 CAV FT KNOX KY

JOHNNY SMITH, SFC  
AQTR-DA, (502) 764-8890

RAY BOSS, CPT, AQTA-DA  
CRC:

UNCLASSIFIED

130913ZNOV01

Legend for Figure 10-3;  
completion instructions follow.  
FM (your unit): Enter unit, location.

**Figure 10-3. Sample Category I SF 368 message format**

---

- TO. Enter the command message address from table 10–1.
- INFO. As needed.
- UNCLAS.
- SUBJECT. Enter category I EIR and an equipment description.
1. POINT OF CONTACT FOR ADDITIONAL INFORMATION IS.. Enter name of person to be reached for more information and/or to ask for an exhibit/sample DSN telephone number and DODAAC.
  2. Enter N/A.
  3. Enter report control number. This is created by using the DODAAC of your unit (6 places), followed by the calendar year (2 places). Then give the number of SF 368s submitted during the calendar year (4 places). For example, the first SF 368 for 1997 sent in by a unit with DODAAC WK4FFF would be WK4FFF970001. Date Defect Found. Calendar date.
  4. Enter the date defect found (calendar date).
  5. Enter the NSN of the bad item.
  6. Enter the nomenclature of the bad component/item.
  - 7A. Enter the name of the manufacturer, contractor, or Government unit that made or repaired the bad item, if known, as well as the city and state.
  - 7B. Enter the code of the manufacturer, contractor, or Government unit that made or repaired the bad item.
  - 7C. Enter the name of the shipper, as well as the city and state.
  8. Enter the manufacturers part number, if it is available. Enter N/A if an NSN has been assigned to the item.
  9. If known, enter in the serial, lot, or batch number of the bad item(s). Use lot numbers for ammunition items since serial numbers do not apply.
  - 10A. Enter the contract number.
  - 10B. Enter the purchase order number.
  - 10C. Enter the requisition number.
  - 10D. Enter the GBL number.
  11. Enter if the item is new or repaired/overhauled.
  12. Enter date received, manufactured repaired, or overhauled.
  13. Enter operating time at failure. Tell how long equipment had been run when the problem was found. That is, how many miles, cycles, hours, or EFC rounds were on the equipment or components. For vehicles bought by GSA, enter in the date the vehicle was first used.
  14. Enter a YES or NO if Government furnished materiel. Enter NO. Only contractors enter YES.
  15. Enter the total number of each item, not the unit of issue. That is, give the actual number of items being reported, no matter what the unit of issue is.
  - 15A. Enter the total of items in the lot or batch in which the bad item was found, if known.
  - 15B. Enter the number of items looked at.
  - 15C. Enter the number of items found to be bad after the inspection.
  - 15D. Enter the number of items in stock, if known.
  - 16A. Enter EI.
  - (1) List the type/model/series of the end item or commodity that the bad item is used with (for example, M16A1 Rifle or Howitzer M102). List the NSN.
  - (2) List the serial number of the end item, if known.
  - 16B. If the bad item is part of a next higher assembly (NHA), enter in the NHA.
    - (1) Enter the NSN of the next higher assembly.
    - (2) Enter the Name of the next higher assembly.
    - (3) Enter the Part Number of the next higher assembly.
    - (4) Enter the Serial Number of the next higher assembly. Lot numbers are used for ammunition items since serial numbers do not apply.
  17. Enter the dollar value of the bad item, if known. Use the AMDF price. List the unit price of one item.
  18. Enter the estimated cost (including overhead) to fix all of the bad items listed. This cost is obtained by multiplying the cost to fix one bad item times the number of bad items. If the actual cost is not known, enter UNK.
  19. Enter YES if the item is under warranty. Enter the expiration date of the warranty in parenthesis; for example ,(1997). Enter NO if it is not. Enter UNK if unknown.
  20. Enter the code for the maintenance unit doing the maintenance: O-Unit; F-Direct Support (DS); H-General Support (GS). D-Depot; L-Special Repair Activity.
  21. List the type of action being done or asked for. If an exhibit is held, show the number of days (at least 55) it is held. If none of the items show the action done or asked for, list other and show the type of action in item 22.
  22. List the following details information.
    - 22A. Enter the proper utilization code from table B-6. For vehicles in administrative use, use code V.
    - 22B. Enter when the problem was found (for example, during scheduled maintenance, test, storage, normal operation, inspection, or handling).
    - 22C. Describe the conditions when the first sign of trouble was noticed that is, stopped working, got too hot or noisy, lost adjustments, didn't perform as needed, didn't hold frequency, and so on.
    - 22D. List TM number, date, and latest change number. Also, list the TM page, figure, and item number.

**Figure 10–3. Sample Category I SF 368 message format**

- 22E. Enter all the details of what was happening before the equipment failed. These details help the investigators. Be sure to tell if any modifications are directly related to the problem. Any other information that might help the investigator should also be give.
- 22F. Provide a brief, but thorough description of the problem.
- 22G. Outline the most likely cause of the problem.
- 22H. Provide a short summary of what was done to correct the problem. If an item is fixed and put back in service, describe the repair. List exhibit information: exhibit held, destroyed, pictures or drawings made, or item turned into supply.
- 22I. Provide any suggestions to improve equipment, stop future failures, improve design, and modify or revise instructions. Note: If an SF 368 is sent in as a result of an accident or a safety related, note in block 22 if a DA Form 285 (U.S. Army Accident Investigation Report) has been sent in and give the date it was sent.
- 22J. Leave blank.
23. Enter the unit name, location, and ZIP Code or APO number where the deficient materiel is located.

Figure 10-3. Sample Category I SF 368 message format

WARNING: Unauthorized persons removing, defacing, or destroying this tag may be subject to a fine of not more than \$1,000 or imprisonment for not more than one year or both. (18 USC 1361)	NSN, PART NO. AND ITEM DESCRIPTION		<b>SUSPENDED TAG-MATERIEL</b>	
	2920-00-335-4678		NEXT INSPECTION DUE	CONDITION CODE L
			INSPECTION ACTIVITY	
			2117 <sup>th</sup> Maint Co, Athens, AL	
			REASON OR AUTHORITY	
			PQDR/EIR Exhibit	
SERIAL NUMBER/LOT NO.	UNIT OF ISSUE	INSPECTOR'S NAME OR STAMP AND DATE		
639-486	EA			
CONTRACT OR PURCHASE ORDER NO.	QUANTITY			
DAAD-05-C-93-KX	271			
REMARKS				

Legend for Figure 10-4;

completion instructions follow.

NSN, PART NO. AND ITEM DESCRIPTION. Enter the NSN, part number, type, model, series, and item name.

NEXT INSPECTION DUE. Leave blank.

CONDITION CODE. Enter the letter L.

INSPECTION ACTIVITY. Enter the units name or UIC of the activity that is preparing the PQDR/EIR.

REASON OR AUTHORITY. Enter "PQDR/EIR Exhibit."

SERIAL NUMBER/LOT NO. Enter the items serial number. If the item is bulk (for example, cord, webbing, rubber), enter the lot number.

UNIT OF ISSUE. Enter the unit of issue; for example, each (ea), gross (gr), dozen (dz).

CONTRACT OR PURCHASE ORDER NO. If known, enter the contract number or the purchase order number. Contract number can be found on item data plate. If it cannot be found, enter UNK.

QUANTITY. Enter the quantity of the item.

INSPECTOR'S NAME OR STAMP AND DATE. Leave blank.

REMARKS. Comment as appropriate.

Figure 10-4. Sample DD Form 1575

PRODUCT QUALITY DEFICIENCY REPORT EXHIBIT			
1. REPORT CONTROL NUMBER WK4FFF030002	2. DATE (YYYYMMDD) 20030210	3. ORIGINATING ACTIVITY 2117th Maint Company	
4. NSN 2920-00-335-4678	5. PART NO.	8. SERIAL/LOT/BATCH NO. 639-486	
7. CONTRACT NO.	8. QTY RECEIVED 1	9. QTY DEFICIENT 1	10. ITEM DESCRIPTION Regulator
11. COMPLAINT NARRATIVE WHAT IS WRONG (Continue on back if necessary)  Low Voltage			
12. NAME (Last, First, Middle Initial) Carlson, Marvin A.		13. TELEPHONE (Include Area Code) DSN 645-9918 (205)955-9918	

DD FORM 2332, JAN 1999

PREVIOUS EDITION MAY BE USED.

WHS/DIOR, Jan 99

Figure 10-5. Sample DD Form 2332 (front)

PRODUCT QUALITY DEFICIENCY REPORT EXHIBIT	
14. SCREENING POINT/DEPOT U.S. Army TANK AUTOMOTIVE AND ARMAMENT COMMAND	
15. DATE EXHIBIT RELEASED (YYYYMMDD) 20030210	16. EXHIBIT RELEASED TO
11. COMPLAINT NARRATIVE (Continued) AND REMARKS	

DD FORM 2332 (BACK), JAN 1999

Legend for Figure 10-5;

completion instructions follow.

1. REPORT CONTROL NUMBER. Enter the Deficiency Reports report control number obtained from block 3 of the original SF 368.
2. DATE (YYYYMMDD). Enter the calendar date (yr/mo/day) when the exhibit was prepared for shipment.
3. ORIGINATING ACTIVITY. Enter the name and address of the activity that prepared for PQDR/EIR.
4. NSN. Enter the NSN for the exhibit. (Same as block 5 of the original SF 368).
5. PART NO. Enter the part number of the item. (Same as block 8 of the original SF 368).
6. SERIAL/LOT/BATCH NO. Enter the serial number of the item. (Same as block 9 of the original SF 368).

Figure 10-5. Sample DD Form 2332 (back)

7. CONTRACT NO. Enter the contract number if one is known; otherwise, leave blank.
8. QTY RECEIVED. Enter the quantity received.
9. QTY DEFICIENT. Enter the quantity that is deficient.
10. ITEM DESCRIPTION. Provide item name, LIN of end item, and a brief description of the item.
11. COMPLAINT NARRATIVE. WHAT IS WRONG (*Continue on back if necessary*). Fill in any pertinent information that aids the shipper and the receiver of the exhibit with the disposition of the item. Include how the item is being shipped; that is, commercial, or through the Army supply system.
12. NAME (Last, First, Middle initial). Enter the name of the person completing the form.
13. TELEPHONE (*Include Area Code*). Enter the phone number (Commercial/DSN) of the person completing this form.
14. SCREENING POINT/DEPOT. Enter the screening point.
15. DATE EXHIBIT RELEASED (YYYYMMDD). Enter date (yr/mo/day) the exhibit was released to the shipper.
16. EXHIBIT RELEASED TO. Enter the name, address, and phone number (DSN/Commercial) of the person and/or company that ships the exhibit.

**Figure 10–5. Sample DD Form 2332 (back)**

---

## **Appendix A References**

### **Section I Required Publications**

#### **AR 385-55**

Prevention of Motor Vehicle Accidents. (Cited in paras 2-1, 2-4, and 3-12.)

#### **AR 600-55**

The Army Driver and Operator Standardization Program (Selection, Training, Testing and Licensing). (Cited in paras 1-1 and 2-1.)

#### **AR 700-138**

Army Logistics Readiness and Sustainability. (Cited in paras 1-1, 3-2, 3-4, 3-6, 3-11, and 3-16.)

#### **AR 750-1**

Army Materiel Maintenance and Policy. (Cited in paras 1-1, 1-7, 3-16, 3-21, 4-3, 4-4, 5-1, 5-7, and 7-2.)

#### **TB 43-0211**

Army Oil Analysis Program Guide for Leaders and Users. (Cited in paras 4-1, 4-3, 4-4, 4-5, and 4-6.) (Available at [https://www.logsa.army.mil/etms/find\\_etm.cfm](https://www.logsa.army.mil/etms/find_etm.cfm).)

### **Section II Related Publications**

A related publication is a source of additional information. The user does not have to read a related publication to understand this publication.

#### **AR 5-17**

The Army Ideas for Excellence Program

#### **AR 12-12**

Processing Discrepancy Reports Against Foreign Military Sales Shipments

#### **AR 25-2**

Information Assurance

#### **AR 25-30**

The Army Publishing Program

#### **AR 40-660**

DOD Hazardous Food and Nonprescription Drug Recall System

#### **AR 50-6**

Nuclear and Chemical Weapon and Materiel, Chemical Surety

#### **AR 55-19**

Marine Casualties

#### **AR 56-9**

Watercraft

#### **AR 58-1**

Management, Acquisition, and Administrative Use of Motor Vehicles

#### **AR 75-1**

Malfunctions Involving Ammunition and Explosives

#### **AR 190-11**

Physical Security of Arms, Ammunition, and Explosives

**AR 190-51**

Security of Unclassified Army Property (Sensitive and Nonsensitive)

**AR 220-1**

Unit Status Reporting

**AR 310-25**

Dictionary of United States Army Terms (Short Title: AD)

**AR 310-50**

Authorized Abbreviation, and Brevity Codes

**AR 380-5**

Department of the Army Information Security Program

**AR 380-86**

Classification of former Chemical Warfare, Chemical and Biological Defense and Nuclear, Biological, Chemical Contamination Survivability Information

**AR 385-40**

Accident Reporting and Records

**AR 420-18**

Facilities Engineering Materiel, Equipment and Relocatable Building Management

**AR 672-20**

Incentive Awards

**AR 700-15**

Packing of Materiel

**AR 700-19**

U.S. Army Munitions Reporting Systems

**AR 700-127**

Integrated Logistics Support

**AR 700-132**

The Joint Oil Analysis Program (JOAP)

**AR 700-139**

Army Warranty Program

**AR 702-7**

Product Quality Deficiency Report Program

**AR 702-7-1**

Reporting of Product Quality Deficiencies Within the U.S. Army

**AR 710-2**

Inventory Management Supply Policy Below the National Level

**AR 710-3**

Asset and Transaction Reporting System

**AR 725-50**

Requisitioning, Receipt and Issue System

**AR 735-11-2**

Reporting of Supply Discrepancies



**AR 750-6**

Ground Safety Notification System

**AR 750-10**

Army Modification Program

**AISM 25-L21-AHN-ZZZ-EM**

Standard Army Maintenance, System Level 1 (SAMS-1) L211000 End User Manual. (Available from [www.us.army.mil/portal/portal\\_home.jhtml](http://www.us.army.mil/portal/portal_home.jhtml).)

**AISM 25-L26-AHO-ZZZ-EM**

Standard Army Maintenance System Level 2 (SAMS-2) L261000 End User Manual. (Available from [www.us.army.mil/portal/portal\\_home.jhtml](http://www.us.army.mil/portal/portal_home.jhtml).)

**AISM 25-L2S-AHR-HPC-EM (F)**

Standard Army Maintenance System-Installation/Table of Distribution and Allowances (SAMS-I/TDA) End User Manual. (Available from [www.us.army.mil/portal/portal\\_home.jhtml](http://www.us.army.mil/portal/portal_home.jhtml).)

**AISM 25-L3Q-AWA-ZZZ-CG**

Commander's Guide, Unit Level Logistics System Ground. (Available from [www.us.army.mil/portal/portal\\_home.jhtml](http://www.us.army.mil/portal/portal_home.jhtml).)

**AISM 25-L3Q-AWC-ZZZ-EM**

ULL-Ground End User Manual (Available from [www.us.army.mil/portal/portal\\_home.jhtml](http://www.us.army.mil/portal/portal_home.jhtml).)

**DA Pam 710-2-1**

Using Unit Supply System (Manual Procedures)

**DA Pam 738-751**

Functional Users Manual for The Army Maintenance Management System—Aviation (TAMMSA)

**DA Pam 750-35**

Guide for Motor Pool Operations

**FM 4-30.3**

Maintenance Operations and Procedures. (Available at [www.adtdl.army.mil/](http://www.adtdl.army.mil/).)

**FM 21-305**

Manual for the Wheeled Vehicle Driver. (Available at [www.adtdl.army.mil](http://www.adtdl.army.mil/).)

**FM 55-30**

Army Motor Transport Units and Operations. (Available at [www.adtdl.army.mil](http://www.adtdl.army.mil/).)

**FM 63-11**

Logistics Support Element Tactics, Techniques and Procedures. (Available at [www.adtdl.army.mil](http://www.adtdl.army.mil/).)

**SB 742-1**

Inspection of Supplies and Equipment Ammunition Surveillance Procedures. (Available at [www.logsa.army.mil](http://www.logsa.army.mil/).)

**TB 38-750-2**

Maintenance Management Procedures for Medical Equipment. (Available at [www.usamma.army.mil/maintenance/med-maint-pub.html](http://www.usamma.army.mil/maintenance/med-maint-pub.html).)

**TB 43-0140**

Instructions for Preparation of Request for Disposition or Waiver (DA Form 3590) for USATROSCOM Equipment and USATACOM, Non-Developmental Item (NDI). (Available at [www.logsa.army.mil](http://www.logsa.army.mil/).)

**TB 55-1900-205-24**

Watercraft Information and Reporting System (WIRS) Data Collection for Configuration Control. (Available at [www.logsa.army.mil](http://www.logsa.army.mil/).)

**TB 600-1**

Procedures for Selection, Training, Testing and Qualifying Operators of Equipment/Systems, excluding Selected Watercraft and Aircraft Managed/Supported by U.S. Army Troop Support and Aviation Materiel Readiness Command. (Available at [www.logsa.army.mil](http://www.logsa.army.mil).)

**TB 600-2**

Procedures for Selection, Training, Testing, Qualifying, and Licensing Operators of Construction Equipment, Material Handling Equipment and Armor-Vehicle-Launched Bridge (AVLB) Managed/ Supported by U.S. Army Tank-automotive and Armaments Command. (Available at [www.logsa.army.mil](http://www.logsa.army.mil).)

**TB 750-25**

Maintenance of Supplies and Equipment: Army Test, Measurement, and Diagnostic Equipment (TMDE) Calibration and Repair Support (CRS) Program. (Available at [www.logsa.army.mil](http://www.logsa.army.mil).)

**(C)TB 750-38**

(U) Alteration of Communication Security Equipment. (Available at [www.us.army.mil/portal/portal\\_home.jhtml](http://www.us.army.mil/portal/portal_home.jhtml).)

**TB 750-651**

Use of Antifreeze Solutions, Antifreeze Extender, Cleaning Compounds and Test Kit in Engine Cooling Systems. (Available at [www.logsa.army.mil](http://www.logsa.army.mil).)

**TM 9-1000-202-14**

Operator's, Organizational, Direct Support and General Support Maintenance Manual for Evaluation of Cannon Tubes. (Available at [www.logsa.army.mil](http://www.logsa.army.mil).)

**TM 38-470**

Storage and Maintenance of Army Prepositioned Stock Materiel. (Available at [www.logsa.army.mil](http://www.logsa.army.mil).)

**TM 55-203**

Maintenance of Railway Cars. (Available at [www.logsa.army.mil](http://www.logsa.army.mil).)

**TWO24-AA-ORD-010**

Ammunition Unserviceable, Suspended, and Limited Use. (Available from <https://www.ois.disa.mil>, then select Asset Profile.)

**FAA Order 1600.2**

Safeguarding Controls and Procedures for Classified National Security. (Available from [www.faa.gov/and/and300/and360/search.cfm](http://www.faa.gov/and/and300/and360/search.cfm).)

**FAA Order 6000.15C**

General Maintenance Handbook for Airway Facilities. (Available from [www.faa.gov/and/and300/and360/search.cfm](http://www.faa.gov/and/and300/and360/search.cfm).)

**FED LOG**

Federal Logistics Record (Available at [www.dlis.dla.mil/FedLog/Subscription](http://www.dlis.dla.mil/FedLog/Subscription).)

**MIL-STD-1168B**

Ammunition Lot Numbering and Ammunition Data Card. (Available at <http://assist.daps.dla.mil/online/start>.)

**Section III****Prescribed Forms**

The following forms are available on the Army Electronic Library CD-Rom and the APD Web site ([www.apd.army.mil](http://www.apd.army.mil)) unless otherwise stated. DD forms are available from the Office of the Secretary of Defense Web site ([www.dior.whs.mil](http://www.dior.whs.mil)).

**DA Form 2401**

Organizational Control Record for Equipment. (Prescribed in para 2-12.)

**DA Form 2402**

Exchange Tag. (Prescribed in paras 2-1 and 3-10.)

**DA Form 2404**

Equipment Inspection and Maintenance Worksheet. (Prescribed in para 2–3.)

**DA Form 2405**

Maintenance Request Register. (Prescribed in paras 3–1 and 3–13.) (Available through usual forms supply channels.)

**DA Form 2407**

Maintenance Request. (Prescribed in paras 2–10 and 3–16.) (Available through usual forms supply channels.)

**DA Form 2407–1**

Maintenance Request–Continuation Sheet. (Prescribed in paras 3–15 and 3–16.) (Available through usual forms supply channels.)

**DA Form 2408–4**

Weapon Record Data. (Prescribed in paras 2–8 and 5–3.)

**DA Form 2408–5**

Equipment Modification Record. (Prescribed in paras 3–16 and 5–5.)

**DA Form 2408–9**

Equipment Control Record. (Prescribed in paras 1–9, 5–2, and 5–7.)

**DA Form 2408–14**

Uncorrected Fault Record. (Prescribed in paras 2–3 and 3–19.)

**DA Form 2408–20**

Oil Analysis Log. (Prescribed in para 5–8.)

**DA Form 2415**

Ammunition Condition Report. (Prescribed in paras 8–1 and 8–4.)

**DA Form 3999–4**

Maintenance Work Request Envelope. (Prescribed in para 3–12.) (Available through usual forms supply channels.)

**DA Form 5409**

Inoperative Equipment Report. (Prescribed in paras 3–1, 3–3, and 3–6.)

**DA Form 5410**

Unit Level Deadlining Parts Report. (Prescribed in paras 3–3 and 3–7.)

**DA Form 5587**

Report of Drydocking, Painting, and Condition of Vessel Bottom. (Prescribed in para 6–1.)

**DA Form 5823**

Equipment Identification Card. (Prescribed in paras 2–1 and 2–9.)

**DA Form 5984–E**

Operator's Permit Record. (Prescribed in paras 2–1 and 2–7.) (Available from ULLS.)

**DA Form 5985–E**

Class Codes. (Prescribed in para 2–7.) (Available from ULLS.)

**DA Form 5987–E**

Motor Equipment Dispatch. (Prescribed in paras 2–4 and 2–10.) (Available from ULLS.)

**DA Form 5987–1–E**

Alert Motor Equipment Dispatch. (Cited in para 2–4.) (Available from ULLS.)

**DA Form 5988–E**

Equipment Maintenance and Inspection Worksheet. (Prescribed in para 3–12.) (Available from ULLS.)

**DA Form 5989-E**

Maintenance Request Register. (Prescribed in para 3-13.) (Available from ULLS.)

**DA Form 5990-E**

Maintenance Request. (Prescribed in para 3-15.) (Available from ULLS.)

**DA Form 5991-E**

Oil Analysis Request. (Prescribed in para 4-1.) (Available from ULLS.)

**DD Form 314**

Preventive Maintenance Schedule and Record. (Prescribed in para 3-11.)

**DD Form 862**

Daily Inspection Worksheet for Diesel Electric Locomotives and Locomotive Cranes. (Prescribed in para 7-3.)

**DD Form 1335**

Field Inspection Data USA, USAX, USNX, DODX Rail Cars. (Prescribed in para 7-4.)

**DD Form 1970**

Motor Equipment Utilization Record. (Prescribed in para 2-11.)

**DD Form 2026**

Oil Analysis Request. (Prescribed in para 2-11.)

**Federal Railroad Administration Form FRA F6180-49A**

Locomotive Inspection and Repair Record. (Prescribed in para 7-5.) (Available from the DOT Federal Railroad Administration.)

**Section IV**

**Referenced Forms**

**DA Form 200**

Transmittal Record

**DA Form 285**

U.S. Army Accident Report

**DA Form 348**

Equipment Operator's Qualification Record

**DA Form 461-5**

Vehicle Classification Inspection

**DA Form 1352**

Army Aircraft Inventory, Status and Flying Time

**DA Form 1687**

Notice of Delegation of Authority Receipt for Supplies

**DA Form 2406**

Materiel Condition Status Report

**DA Form 2765-1**

Request for Issue or Turn-In

**DA Form 3254**

Oil Analysis Recommendation and Feedback

**DA Form 3266-1**

Army Missile Materiel Readiness Report

**DA Form 3266-2**

Missile Materiel Condition Status Report Worksheet

**DA Form 3590**

Request for Disposition or Waiver

**DA Form 4993**

Harbor Boat and Engine Department Log for Class A and C-1 Vessels

**DA Form 4640**

Harbor Boat Deck Department Log for Class A and B Vessels. (Available through normal forms supply channels.)

**DA Form 5273**

Harbor Boat Deck and Engine Log for Class A B Vessels

**DA Form 5533**

SMART Suggestion Form

**DA Form 5982-E**

Dispatch Control Log

**DD Form 518**

Accident Identification Card

**DD Form 1348**

DOD Single Line Item Requisition System Document (Manual). (Available through usual forms supply channels.)

**DD Form 1575**

Suspended Tag—Materiel. (Available through usual forms supply channels.)

**DD Form 1576**

Test/Modification Tag—Materiel. (Available through usual forms supply channels.)

**DD Form 1577**

Unserviceable (Condemned) Tag—Materiel. (Available through usual forms supply channels.)

**DD Form 1650**

Ammunition Data Card. (Available through usual forms supply channels.)

**DD Form 2332**

Product Quality Deficiency Report Exhibit. (Available through usual forms supply channels.)

**FAA Form 6030-1**

Facility Maintenance Log. (Available from the Federal Aviation Agency, tel 405-954-4887.)

**SF Form 91**

Motor Vehicle Accident Report. (Available from [www.gsa.gov/Portal/gsa/ep/home.do?tabId=0](http://www.gsa.gov/Portal/gsa/ep/home.do?tabId=0).)

**SF 120**

Report of Excess Personal Property. (Available from [www.gsa.gov/Portal/gsa/ep/home.do?tabId=0](http://www.gsa.gov/Portal/gsa/ep/home.do?tabId=0).)

**SF Form 364**

Report of Discrepancy (ROD). (Available from [www.gsa.gov/Portal/gsa/ep/home.do?tabId=0](http://www.gsa.gov/Portal/gsa/ep/home.do?tabId=0).)

**SF Form 368**

Product Quality Deficiency Report (PQDR). (Available from [www.gsa.gov/Portal/gsa/ep/home.do?tabId=0](http://www.gsa.gov/Portal/gsa/ep/home.do?tabId=0).)

## Appendix B Codes and Conversion Tables

### B-1. Introduction

The codes and conversion tables in this appendix are used to prepare the referenced forms in this pamphlet (for example, DA Forms 2407/2407-1, DA Form 2408-9, DA Form 5409, and DA Form 5410) (see tables B-1 through B-25). These codes are used as the standard when reporting maintenance status functions.

### B-2. Exception authority

No additional codes are assigned unless authorized by the HQDA, DCS, G-4, ATTN: DALO-SMM.

**Table B-1**  
**Failure codes, alphabetical**

Code	Description
717	Accident damage
127	Adjustment improper
002	Air leak
128	Air start failure
031	Alignment improper
007	Arcing, arced
693	Audio faulty
129	Backfiring
731	Battle damage
710	Bearing or bushing failure
780	Bent
705	Beyond specified tolerance
135	Binding, includes friction excessive, locked
050	Blistered
060	Brittle
070	Broken
108	Broken safety wire or key
720	Brush failure/worn excessively
109	Buckled, or twisted
900	Burned, includes charred
080	Burned out
171	Burred
111	Burst, exploded, ruptured
024	Calibration incorrect
025	Capacitance incorrect
120	Chafed
910	Chipped
180	Clogged
026	Cold solder joint
027	Collapsed
160	Contact/connection defective
306	Contamination
114	Controls inoperative

**Table B-1**  
**Failure codes, alphabetical—Continued**

844	Corona effect
170	Corroded (metal), includes rusting
190	Cracked
845	Crystallized
029	Current incorrect
116	Cut
115	Damaged
846	Delaminated
200	Dented
210	Detent action poor
117	Deteriorated
968	Dioding
118	Disconnected
230	Dirty
201	Distortion
999	Drive/disk failure/crash (computers)
235	Dry
293	Electrical power loss
295	Electromagnetic environmental effect/Electronic interference/discharge
231	Elongated
234	Excessive G forces
015	Excessive noise (electronics)
508	Exposed to fire/high temperature
507	Exposed to salt water environment
290	Fails diagnostic/automatic tests
051	Fails to tune or drifts
602	Failure caused by other component failure
281	Faulty instrument reading
055	Feedback incorrect
240	Flaking
069	Flame out
301	Foreign object damage
250	Frayed
037	Fluctuates, unstable
748	Frequency, erratic or incorrect
179	Fuel pressure incorrect
280	Fungus effect
472	Fuse blown
061	Fused, includes melted
001	Gassy
214	Grooved
300	Grounded
311	Hard landing

**Table B-1**  
**Failure codes, alphabetical—Continued**

855	Heat damage
320	High voltage breakdown
065	High VSWR
079	Hot firing damage
317	Hot start
248	Icing
916	Impending or incipient failure indicated by spectrometric oil analysis
703	Improper amplitude
627	Improper attenuation
688	Improper energy response
239	Improper fit, form, function
689	Improper source output
340	Improperly installed
088	Incorrect gain
064	Incorrect modulation
169	Incorrect voltage
350	Insulation breakdown
081	Interference
360	Intermittent
374	Internal failure
370	Jammed
381	Leaking (liquid)
382	Liquid/ vapor lock
730	Loose
383	Lock-on malfunction
385	Loose or missing rivets
105	Loose bolts, nuts, screws
181	Low compression
004	Low GM or emission
537	Low power or torque
092	Low power (electronic)
500	Lubrication (over or under) or absent
604	Manifold pressure beyond limits
040	Mechanical binding
372	Metal on magnetic plug
009	Microphonic
253	Misfires
106	Missing bolts, nuts, screws, safety wire
908	Miswired
420	Moisture saturation (condensation)
425	Nicked
799	No defect
305	No fuel cutoff



**Table B-1**  
**Failure codes, alphabetical—Continued**

367	No indicating lights
022	No oscillation
255	No output/incorrect output
008	Noisy (chattering)
398	Oil consumption excessive
603	Oil in induction system
307	Oil leak
405	Oil pressure incorrect
450	Open
003	Open filament tube circuit
457	Oscillating
790	Out of adjustment, includes out of tolerance/calibration
461	Output too high
462	Output too low
481	Over heats
021	Over loaded
464	Over speed
259	Over size
927	Pinched
520	Pitted
530	Polarity reversed
263	Poor bonding
964	Poor spectrum
977	Pressure incorrect
540	Punctured
476	Rate of feather slow
567	Resistance high
568	Resistance low
734	Rise time incorrect
324	RPM beta governing faulty
315	RPM fluctuation/incorrect
740	Saturation resistance high
935	Scored
473	Seal/gasket blown
840	Seized
807	Servo mag amp time constant
585	Sheared
196	Shorted
163	Slip ring or commutator failure
640	Slippage
314	Slow acceleration
318	Slow deceleration
159	Smoking

**Table B-1**  
**Failure codes, alphabetical—Continued**

279	Spray pattern defective
271	Sprung
513	Stalls, compressor
329	Starting stall
660	Stripped
945	Structural failure
504	Sudden stoppage, blade/propeller strike
519	Surged
649	Sweep malfunction
695	Sync absent or incorrect
334	Temperature incorrect
664	Tension incorrect
274	Timing off
379	Tooth broken on gear
947	Torn
167	Torque incorrect
816	Total impedance, high
817	Total impedance, low
561	Unable to adjust limit
670	Unbalanced
275	Undersize
680	Unstable
690	Vibration excessive
692	Video faulty
701	Warped
622	Wet
722	Weld cracked, broken, or defective
020	Worn Excessively

**Table B-2**  
**Failure codes, numerical**

<b>Code</b>	<b>Description</b>
001	Gassy
002	Air leak
003	Open filament tube circuit
004	Low GM or emission
007	Arcing, arced
008	Noisy (chattering)
009	Microphonic
015	Excessive noise (electronics)
020	Worn excessively
021	Over loaded
022	No oscillation

**Table B-2**  
**Failure codes, numerical—Continued**

024	Calibration incorrect
025	Capacitance incorrect
026	Cold solder joint
027	Collapsed
029	Current incorrect
031	Alignment improper
037	Fluctuates/unstable
040	Mechanical binding
050	Blistered
051	Fails to tune or drifts
055	Feedback incorrect
060	Brittle
061	Fused, includes melted
064	Incorrect modulation
065	High VSWR
069	Flame out
070	Broken
079	Hot firing damage
080	Burned out
081	Interference
088	Incorrect gain
092	Low power (electronic)
105	Loose bolts, nuts, screws
108	Broken safety wire or key
109	Buckled or twisted
111	Burst, exploded, ruptured
114	Controls inoperative
115	Damaged
116	Cut
117	Deteriorated
118	Disconnected
120	Chafed
127	Adjustment improper
128	Air start failure
129	Backfiring
135	Binding, includes friction excessive, locked
159	Smoking
160	Contact/connection defective
163	Slip ring or commutator failure
167	Torque incorrect
169	Incorrect voltage
170	Corroded (metal), includes rusting
171	Burred

**Table B-2**  
**Failure codes, numerical—Continued**

179	Fuel pressure incorrect
180	Clogged
181	Low compression
190	Cracked
196	Shorted
200	Dented
201	Distortion
210	Detent action poor
214	Grooved
230	Dirty
231	Elongated
234	Excessive G forces
235	Dry
239	Improper fit, form, function
240	Flaking
248	Icing
250	Frayed
253	Misfires
255	No output/incorrect output
259	Over size
263	Poor bonding
271	Sprung
274	Timing off
275	Undersize
279	Spray pattern defective
280	Fungus effect
281	Faulty instrument reading
290	Fails diagnostic/automatic tests
293	Electrical power loss
295	Electromagnetic environmental effect/Electronic interference/discharge
300	Grounded
301	Foreign object damage
305	No fuel cutoff
306	Contamination
307	Oil leak
311	Hard landing
314	Slow acceleration
315	RPM fluctuation/incorrect
317	Hot start
318	Slow deceleration
320	High voltage breakdown
324	RPM beta governing faulty
329	Starting stall

**Table B-2**  
**Failure codes, numerical—Continued**

334	Temperature incorrect
340	Improperly installed
350	Insulation breakdown
360	Intermittent
367	No indicating lights
370	Jammed
372	Metal on magnetic plug
379	Tooth broken on gear
381	Leaking (liquid)
382	Liquid/vapor lock
398	Oil consumption excessive
405	Oil pressure incorrect
420	Moisture saturation (condensation)
425	Nicked
450	Open
457	Oscillating
461	Output too high
462	Output too low
464	Over speed
472	Fuse blown
473	Seal/gasket blown
476	Rate of feather slow
481	Over heats
500	Lubrication (over or under) or absent
504	Sudden stoppage, blade/propeller strike
507	Exposed to salt water environment
508	Exposed to fire/high temperature
513	Stalls, compressor
519	Surged
520	Pitted
530	Polarity reversed
537	Low power or torque
540	Punctured
561	Unable to adjust limit
567	Resistance high
568	Resistance low
585	Sheared
602	Failure caused by other component failure
603	Oil in induction system
604	Manifold pressure beyond limits
622	Wet
627	Improper attenuation
640	Slippage

**Table B-2**  
**Failure codes, numerical—Continued**

649	Sweep malfunction
660	Stripped
664	Tension incorrect
670	Unbalanced
680	Unstable
688	Improper energy response
689	Improper source output
690	Vibration excessive
692	Video faulty
693	Audio faulty
695	Sync absent or incorrect
701	Warped
703	Improper amplitude
705	Beyond specified tolerance
710	Bearing or bushing failure
717	Accident damage
720	Brush failure/worn excessively
722	Weld cracked, broken or defective
730	Loose
731	Battle damage
734	Rise time incorrect
740	Saturation resistance high
748	Frequency, erratic or incorrect
780	Bent
790	Out of adjustment includes out of tolerance/calibration
799	No defect
807	Servo mag amp time constant
816	Total impedance, high
817	Total impedance, low
840	Seized
844	Corona effect
845	Crystallized
846	Delaminated
855	Heat damage
900	Burned, includes charred
908	Miswired
910	Chipped
916	Impending or incipient failure indicated by spectrometric oil analysis
927	Pinched
935	Scored
945	Structural failure
947	Torn
964	Poor spectrum

**Table B-2**  
**Failure codes, numerical—Continued**

968	Dioding
977	Pressure incorrect
999	Drive/disk failure/crash (computers)

**Table B-3**  
**Failure detected during codes**

Code	Description
A	Scheduled maintenance
B	Handling
C	Test
D	Normal operation
E	Storage
F	Inspection
G	Flight
H	Other
J	Calibration

**Table B-4**  
**First indication of trouble codes**

Code	Description
008	Noisy
068	Inoperative
258	Overheating
387	Low performance
790	Out of adjustment
360	Intermittent
432	Off frequency
680	Unstable
077	Accident
777	Mid-service life
099	Other

**Table B-5**  
**Action codes**

Code	Description
A	Replaced. This code is used when an item (repair parts, components, and so on) is removed and replaced concurrently (or at a later time) by a like or an equivalent item (except for gun/howitzer tubes and hourmeters/odometers, see codes W and X). For the purpose of avionics, when the equivalent item changes the avionic system designation, use action codes "R" and "S" in lieu of action code "A."
B	Adjusted. This code is used when tightening, adjusting, bleeding, rigging or activating reset buttons or switches, regulating, and so on.
C	Repaired. This code is used when a reparable item is repaired. This includes, but is not limited to, disassembly, cleaning incidental to repair action, inspection, adjustment, internal lubrication, replacement of integral parts, assemblies and sub-assemblies, and welding.

**Table B-5**  
**Action codes—Continued**

D	Manufacture/Fabrication Of Repair Parts. This code is used when repair parts are manufactured or fabricated from stock. This includes but is not limited to such items as hydraulic tubes, lines and hoses, and noncritical airframe members and brackets.
E	Services. This code is used to report all service actions performed by maintenance personnel, to include, but not be limited to compliance with Lube Orders (LO), performance of preventive maintenance services (PMS).
F	Initial Inspection. This code is used when inspecting items to establish maintenance action(s) required to return item to serviceable status.
G	Final Inspection. This code is used when inspecting items to determine acceptability of maintenance accomplished.
H	MWO. This code is used to identify the application of Modification Work Orders.
I	Not Used.
J	Tested. This code is used when performing diagnostic or mechanical tests which are used to measure the performance of an item against established serviceability/technical standards.
K	In Process Inspection.
L	Removed and Installed. This code is used when an item is removed for any reason and the same item is reinstalled.
M	Checked, NRTS. This code is used when an item is checked or tested and it is determined to be "Not Repairable at This Station or site." Note: Local policy may prescribe use of NRTS codes in table B-10.
N	Checked. Not Repairable. This code is used when an item is checked or tested and it is determined to be nonreparable (condemned). This code applies also for items beyond economic repair limitations.
O	Overhaul.
P	Checked, Serviceable. This code is used for items checked or tested and no repair is required. This code is applicable only if it is determined that a reported fault does not exist or cannot be duplicated.
Q	MWO Removal. This code is used to identify the removal of an DAMWO as a result of cancellation of the DAMWO requirement.
R	Removed. This code is used when an item is removed, and only the removal time is to be accounted for.
S	Installed. This code is used when an item is installed, and only the installation time is to be accounted for.
T	TB compliance. This code is used to identify the compliance with the instructions of a specifically cited technical bulletin.
U	Decontamination of equipment.
V	Special Purpose Alteration (SPA) apply/applied.
W	Hourmeter/Odometer Change. This code is used to indicate the replacement of an hour meter and/or odometer.
X	Gun Change. This code is used to report the replacement of a gun.
Y	Special Mission Alteration (SMA) apply/applied.
Z	Safety Recall Order (SRO) apply/applied.
0	Modification By Replacement. This code is used when modification (DAMWO) of an end item is accomplished by replacing an unmodified component/assembly with a modified component/assembly.
8	Maintenance action not able to be performed (SAMS Unique).
9	Modification by replacement.

**Table B-6**  
**Utilization codes**

Code	Description
0	Active Components (except as otherwise listed)
1	Depot Stock
2	Post supply activities
3	(not used)
4	Operational readiness float (ORF)
5	Installation Maintenance and Service Equipment
6	(Not Used)



**Table B-6**  
**Utilization codes—Continued**

7	Army National Guard, except mobilization and training equipment sites (MATES)
8	Army National Guard (MATES)
9	Air Force National Guard units
A	Army Reserve units, except equipment pools
B	Army Reserve units, equipment pools
C	Air Force Reserve
D	Army ROTC
E	Air Force ROTC
G	Defense Atomic Support Agency
H	U.S. Army Intelligence and Security Command
J	Defense Communications Security Agency
K	U.S. Army Training and Doctrine Command
L	U.S. Army Test and Evaluation Command
M	Civilian Support Units
N	Prepositioned stock except AWRPS
P	Depot installation equipment
Q	Equipment assigned to service schools and training centers
R	Military Assistance Program (MAP)
S	Overhaul facility, military
T	Overhaul facility, commercial
U	Manufacturing facility
V	Passenger-Carrying and General Purpose
W	Equipment assigned to National Training Centers
X	Repair Cycle Float (RCF)
Y	Army War Reserve Prepositioned Sets (AWRPS)

**Table B-7**  
**Time conversion codes**

Minutes	Parts of hour
0	0.0
1-6	0.1
7-12	0.2
13-18	0.3
19-24	0.4
25-30	0.5
31-36	0.6
37-42	0.7
43-48	0.8
49-54	0.9
55-60	1.0

**Table B-7**  
**Time conversion codes—Continued**

Notes:

Time required in "man-hour" columns of DA Forms contained in this pamphlet are reported in hours and tenths of hours. When entering hours or tenths of hours on forms, a zero should be entered on either side of the decimal where appropriate, for example, 2.0 when entering full hours, 0.7 when entering tenths of hours.

**Table B-8**  
**Equipment repair action code**

Code	Description
W	Repairs performed on selected combat or tactical vehicles under the CONUS Tactical Wheeled Vehicle Repair Program, OCONUS—Theater Intermediate General Support Repair Program (GSRP) (formerly the Theater Army Repair Program (TARP)), or other DA-approved programs requiring DA Form 2408-9.

**Table B-9**  
**Miscellaneous codes**

Code	Purpose
Unit Identification Code.	a. For U.S. Army units, organizations, and activities, see DOD 4000, DODAAC UIC Cross Ref World Wide Report. b. For contractors, manufacturers, and commercial activities, use their five-digit code, as prescribed in SB 708-43, preceded by the letter "K"; for example, General Motors-K24617.
Department of Defense Activity Address Code (DODAAC).	a. For U.S. Army units, organizations, activities, and others, see DOD Activity Address Directory (DODAAD) 4000.25-(U). b. This six-digit code gives a delivery address for supplies and equipment and is used in preparation of category I and II deficiency reports.

**Table B-10**  
**NRTS (not reparable this station) codes**

Code	Description
1	Bench Checked-NRTS (Not Reparable This Station), Repair Not Authorized. This code is entered when the shop is not authorized to accomplish the repair. This code is not used unless the repair of the item is specifically prohibited by current technical directives.
2	Bench Check-NRTS—Lack of Equipment, Tools, or Facilities. This code is entered when repair cannot be accomplished due to lack of equipment, tools, or facilities. Lack of authorization for the required tools, equipment, or facilities does not preclude use of this code.
3	Bench-Checked-NRTS—Lack of Technical Skills. This code is entered when repair cannot be accomplished due to lack of technically qualified people.
4	Bench Checked-NRTS—Lack of Parts. This code is entered when parts are not available to accomplish repair.
5	Bench Checked-NRTS—Shop Backlog. This code is entered when repair cannot be accomplished due to excessive shop backlog.
6	Bench Checked-NRTS—Lack of Technical Data. This code is entered when repair cannot be accomplished because of the lack of maintenance manuals, drawings, and so on, that describe detailed repair procedures and requirements.
7	Bench Checked-NRTS—Excess to Base Requirements. This code is entered when repair will not be scheduled for shop repair due to item being excess to base requirements.
8	This code not used.
9	Bench Checked-Condemned. This code is entered when the item cannot be repaired, and is to be processed for condemnation, reclamation, or salvage. This code will also be used when a "condemned" condition is discovered during support maintenance disassembly or repair.

**Table B-11**  
**Vehicle use codes**

Code	Description
A	Army Operated. Includes any Army-owned passenger carrying and general purpose vehicles listed in figure E-4, used or operated by Army personnel (GOGO).
B	Contractor Operated. Includes any Army-owned passenger carrying and general purpose vehicles listed in figure E-4, that are furnished to contractors by the Department of the Army for contractor use (GOCO).
R	Facilities Engineering Vehicles. Includes special purpose (commercial) and military design vehicles used on installations real in the performance of property management activities by installation level director of engineering and housing personnel.
X	All Other Special Purpose Vehicles. Includes all other special purpose vehicles not covered by code R.

**Table B-12**  
**Equipment acceptance codes**

Code	Description
A	Accepted from a manufacturer (new procurement).
B	Accepted from local procurement.

**Table B-13**  
**Equipment usage codes**

Code	Description
C	Periodic usage report.
D	Special usage report (as directed by DA).

**Table B-14**  
**Equipment transfer codes**

Code	Description
1	Shipped to another property account.
2	Received from another property account.

**Table B-15**  
**Equipment loss codes**

Code	Description
E	Loss due to disassembly of a reportable integrated set/assembly.
I	Combat loss (abandoned, captured, destroyed).
J	Turned in to Defense Reutilization and Marketing Office(DRMO) or salvage point.
K	Shipped to Other (non-Army) Government, departments, agencies, services, MAP or foreign military sales.
L	Physical loss other than combat (pilferage, theft, and so on)
M	Identification loss, NSN redesignation.
N	Identification loss, integrated into a set assembly or system; or a change of equipment serial number or registration number.
Z	Unit reconciliation

**Table B-16**  
**Equipment gain codes**

Code	Description
F	Gain of an individual reportable item as a result of disassembly of an integrated set/assembly.
P	Combat gain (recaptured or recovered).
Q	Reclaimed from Defense Reutilization and Marketing Office or cannibalization point.
R	Received from other (non-Army) Government departments, agencies or services or security/Military Assistance Program (MAP) countries.
S	Identification gain, redesignated NSN.
T	Identification gain, integrated set assembly with new NSN; or a change of equipment serial number or registration number.
U	Inventory adjustment gain (found on post). This code is also used to report the gain of reportable items of equipment which have been added to appendix E by TWX or changes to this pamphlet and to report the gain of previously unknown or unreported assets.

**Table B-17**  
**Equipment overhaul code**

Code	Description
V	Item overhauled at an Army or contractor facility.

**Table B-18**  
**Equipment category codes (ECC)**

Code	Description
A	Aircraft
B	Air Defense Systems
C	Missile Systems Land Combat
D	Artillery Weapons
E	Small Arms
F	Tanks
G	Combat Vehicles
H	Tactical Vehicles
J	Communications And Electronic Equipment
K	Electronic Test Equipment
L	Floating Equipment
M	Railway Equipment
N	Construction Equipment
O	Medical And Dental Equipment
P	Material Handling Equipment
Q	Support Equipment
R	Ammunition And Ammunition Equipment
S	Installation/Depot Peculiar Service Equipment
T	Machine Tools
U	Shop Support Equipment
V	nontactical Wheeled Vehicles (Commercial Design)
W	Furniture And Appliances
X	Office Equipment

**Table B-18**  
**Equipment category codes (ECC)—Continued**

Y	Tools Not Listed Else Where
Z	Equipment Not Listed Elsewhere
A	Aircraft
AC	Air traffic control equipment
AF	Fixed wing
AL	Aviation life support equipment
AR	Rotary wing
AT	Training flight simulator trainer
AX	Ancillary equipment
AZ	Tools and test equipment/Training Aids/Devices
B	Air Defense System
BD	AN/TSQ73
BE	GM System Hawk
BF	Armament subsystem helicopter M22
BJ	Redeye
BK	Chaparral
BL	Data converter air defense system
BM	LSDIS
BN	STINGER
BP	PATRIOT
BT	Target missile systems
BU	Guides missile systems
BV	Miscellaneous
BX	Training and handling equipment
BZ	Tools and test equipment/Training Aids/Devices
C	Missile Systems Land Combat
CA	Land Combat Support System (LCSS)
CB	TOW
CC	TOWII
CD	DRAGON
CE	SLUFAE
CF	G/VLLD M981, G/VLLD Ground
CG	Multiple Rocket Launcher System (MLRS)
CH	HELLFIRE
CJ	Mast Mounted Sight (MMS)
CL	LANCE
CN	Honest John
CP	Air-to-Air stinger
CQ	Little John
CV	Shillelagh
CW	Sergeant
CX	Training and handling equipment
CY	Miscellaneous

**Table B-18**  
**Equipment category codes (ECC)—Continued**

CZ	Tools and test equipment/Training Aids/Devices
D	Artillery Weapons
DA	Towed howitzers
DB	Mortars
DC	Recoilless rifles
DD	Recoilless guns
DE	Rocket launchers
DF	Computer guns
DG	Anti aircraft guns
DX	Training equipment
DZ	Tools and test equipment/Training Aids/Devices
E	Small Arms
EA	Armament subsystems
EB	Rifles
EC	Machine guns
ED	Grenade launchers
EE	Submachine guns
EF	Automatic guns
EG	Rocket launchers
EH	Carbines
EI	Guns, other
EJ	Hand guns
EK	Shotguns
EM	Small arms, other
EX	Ancillary equipment
EY	Miscellaneous support equipment
EZ	Tools and test equipment/Training Aids/Devices
F	Tanks
FA	76MM
FB	90MM, 105MM, 120MM
FC	152MM
FX	Training equipment
FZ	Tools and test equipment/Training Aids/Devices
G	Combat Vehicles
GA	Self-propelled howitzers
GB	Self-propelled mortars
GC	Combat vehicle, anti-tank
GD	Self-propelled guns
GE	Combat wheeled vehicles
GF	Recovery vehicles
GG	Combat engineer vehicles
GJ	Tractors
GK	Launcher, bridge

**Table B-18**  
**Equipment category codes (ECC)—Continued**

GL	Personnel carriers
GM	Armored reconnaissance airborne assault vehicles
GN	Amphibious cargo carriers
GP	Carrier, commander reconnaissance
GQ	Carriers, command post
GR	Carriers, cargo tracked
GS	Carriers, flamethrower (M132A1)
GW	Carriers, other
GX	Ancillary equipment
GZ	Tools and test equipment/Training Aids/Devices
H	Tactical Vehicles
HA	Trucks, 1/4 ton, ambulance
HB	Trucks, 1/4 ton, utility
HC	Trucks, 1/2 ton, utility
HD	Trucks, 3/4 ton, cargo
HE	Trucks, 3/4 ton, other
HF	Trucks, 1 1/4 ton
HG	Trucks, 2 1/2 ton, cargo
HH	Trucks, 2 1/2 ton, other
HI	Trucks, 5 ton, cargo
HJ	Trucks, 5 ton, other
HK	Trucks, 8 ton
HL	Trucks, 10 ton
HM	Trucks, 12 to 25 tons
HO	Trucks, over 25 tons
HP	Carriers, utility, articulated
HQ	Armored cars
HR	Armored security vehicles
HS	Semi-trailers
HT	Trailers
HV	Light armored vehicles
HU	Truck chassis
HW	Trailer chassis (all)
HX	Sleds
HY	Dollies
HZ	Tools and test equipment/Training Aids/Devices
J	Communications and Electronic Equipment
JA	Infrared surveillance systems
JB	Communications security equipment
JC	Telephone-telegraph terminals
JD	Radiac sets and meters
JE	Special use intelligence equipment
JF	Interrogator sets

**Table B-18**  
**Equipment category codes (ECC)—Continued**

JG	Teletypewriters
JH	signals intelligence/electronic warfar equipment
JI	Intercommunication sets
JJ	Intrusion detections systems
JL	Laser
JM	Meteorological
JP	Radar
JR	Radios
JS	Operation central communications
JT	Transmitters
JU	Receivers
JX	Ancillary equipment
JY	Digital computer systems
JZ	Tools and test equipment/Training Aids/Devices
K	Electronic Test Equipment
KA	Equipment
KB	Meters
KC	Analyzers
KD	Wire communications
KE	Radiac equipment/radiac test equipment
KF	Meteorological
KH	Avionics
KJ	Computers
KK	Chargers
KL	Signal Generators
KY	Miscellaneous support equipment
KZ	Tools and test equipment/Training Aids/Devices
L	Floating Equipment
LA	Barges
LB	Boat, bridging
LC	Boats, passenger pickets and utility
LD	Landing crafts
LE	Tugs
LF	Vessels
LG	Propelling units, outboard
LH	Barge cranes
LJ	Boat, trailers
LK	Boats, recreational
LL	Lighter, Amphibious
LM	Transport mobile assault bridge
LN	Boats, assault
LP	Boats, reconnaissance
LX	Ancillary equipment



**Table B-18**  
**Equipment category codes (ECC)—Continued**

LY	Miscellaneous
LZ	Tools and test equipment/Training Aids/Devices
M	Railway Equipment
MA	Cars
MB	Maintenance cars
MC	Diesel locomotives
MD	Cranes
ME	Other
MX	Ancillary equipment
MZ	Tools and equipment/Training Aids/Device
N	Construction Equipment
NA	Crushers and plants
NB	Paving equip/mixers/distributors
NC	Earthmoving
ND	Tractors
NE	Graders
NF	Cranes/shovels/excavators
NG	Loaders
NH	Rollers
NJ	Drills
NK	Bridges, erection and ferry
NL	Bridges, armor vehicle launch
NM	Spreaders (all types)
NN	Trucks (CCE)
NO	Bridges, floating
NP	Kettles, heating bituminous
NQ	Dry support bridge
NR	Bridges, dry support
NS	Landing mat sets
NT	Heaters
NU	Conveyors/elevators
NV	Special/miscellaneous
NX	Ancillary equipment
NZ	Tools and test equipment/Training Aids/Devices
O	Medical and Dental Equipment
OA	Anesthesia apparatus
OB	Blood Gas Apparatus/analyzers
OC	Centrifuges
OD	X-ray film processing systems
OE	Defibrillators/monitors/diagnostics
OF	Dental operating units
OG	Medical compressor/dehydrator
OH	Table operating field

**Table B-18**  
**Equipment category codes (ECC)—Continued**

OI	Radiographics
OJ	Biological refrigerator/freezers
OK	Respirator/ventilator
OL	Hospital sinks
OM	Sterilization equipment
ON	Suction and pressure apparatus
OO	Medical equipment set (MES)
OP	Medical material set (MMS)
OQ	X-ray apparatus
OR	Miscellaneous/general
OS	Surgical
OT	Medical ophthalmic/optical
OU	Environmental/biological detection
OV	Endoscopes. bronchoscopes
OW	Medical laboratory
OX	Ancillary equipment
OZ	Tools and test equipment
P	Material Handling Equipment
PA	Cranes warehouse
PB	Trucks, forklift electric
PC	Trucks, forklift GED
PD	Trucks, platform
PE	Tractors, warehouse
PF	Trucks, straddle
PG	Trucks, forklift-rough terrain
PH	Trucks, forklift-airmobile
PI	Trucks, forklift-other, DED
PJ	Trucks stocks elector
PK	Truck Cranes, 140 ton or over
PL	Trucks, fork lifts, other
PM	Hoists
PN	Cranes, floor and overhead
PO	Conveyors
PP	Hand trucks
PQ	Ramp docks
PR	Trailers
PS	Trucks, material handling
PT	Pallet jacks
PX	Ancillary equipment
PY	Miscellaneous support equipment
PZ	Tools and test equipment/Training Aids/Devices
Q	Support Equipment
QA	Bakery
QB	Generators

**Table B-18**  
**Equipment category codes (ECC)—Continued**

QC	Compressors
QD	Tan/pump units
QE	Laundry units
QF	Air conditioners
QG	Welding machines
QH	Lubricating and servicing units
QI	Liquid oxygen converters
QJ	Water purification units
QK	Generating and charging plants
QL	Elevators hydraulic (guided missile)
QM	Chemical protection
QN	Lighting equipment
QP	Power plants/units
QQ	Reproduction equipment
QR	Topographic/measuring/surveying/mapping
QS	Repair shop equipment
QT	Special repair and utilities
QU	Firefighting equipment
QV	Special shop equipment
QW	Detection equipment/recon sys/bio agent
QX	Refrigeration
QY	Miscellaneous support equipment
QZ	Tools and test equipment/Training Aids/Devices
R	Ammunition and ammunition equipment
RA	Punch primers, and so on
RB	Protection devices
RD	Furnaces
RE	Devices/fixtures
RF	Panels
RG	Plants
RH	Tanks
RI	Hoppers
RJ	Vacuum chambers/separators
RK	Special equipment
RL	Ammunition material
RN	Selected ammunition
RP	Special EOD tools and equipment
RQ	Test and handling equipment
RT	Ammunition peculiar equipment (APE)
RZ	Tools and test equipment/Training Aids/Devices
S	Installations Depot Peculiar Service Equipment
SA	Photographic/television
SB	Public address

**Table B-18**  
**Equipment category codes (ECC)—Continued**

SC	Maintenance platforms
SD	Measuring
SE	Traffic controls
SF	Conditioner/polish scrubbing
SG	Dryers/filters
SH	Driver training/testing
SI	Optical equipment
SJ	Safety
SK	Vacuum lens coating
SL	Laboratory tables
SM	Plastic processing
SN	Electrical charges
SO	Laboratory equipment
SP	Laboratory equipment-continued
SQ	Chilling machines
SR	Communications-commercial
SS	Shelter/structure
ST	Plating/cleaning tanks
SU	Duplicating machines
SV	Projectors (movie films)
SW	Recorder/reproducer (audio and/or video)
SX	Ancillary equipment
SY	Lawnmowers, snow removal, ground maintenance, and other maintenance and services (MS) equipment
SZ	Tools and test equipment/Training Aids/Devices
T	Machine Tools
TA	Saws
TB	Lathes
TC	Grinders
TD	Planers
TE	Shapers
TF	Forming machines
TG	Screw manufacturing machines
TH	Threading machines
TJ	Surfacers
TK	Boring
TL	Honing
TM	Mortisers
TN	Jointers
TO	Routers
TP	Broaching
TQ	Shear/punch/notch
TR	Cutters
TS	Sanders

**Table B-18**  
**Equipment category codes (ECC)—Continued**

TT	Milling
TU	Lapping
TV	Presses
TW	Drills
TX	Special
TY	Ancillary equipment
TZ	Tools and test equipment/Training Aids/Devices
U	Shop Support Equipment
UA	Heat treating
UC	Clean, paint, process
UD	Rubber process
UE	Packaging and packing
UF	Textile/leather
UG	Jacks
UH	Storage equipment
UI	Laser equipment
UJ	Scales
UK	Fans
UL	Tire and wheel repair
UM	Vehicle track presses
UN	Lubricating aids
UP	Heaters
UQ	Metalizing equipment
UR	Reels
US	Distribution systems
UT	Splicing equipment
UU	Positioners
UX	Ancillary equipment
UZ	Tools and test equipment/Training Aids/Devices
V	nontactical Wheel Vehicle (Commercial Design)
VA	Trucks, bolster
VB	Trucks dump
VC	Trucks, firefighting
VD	Trucks, hopper
VE	Trucks, maintenance
VF	Trucks, refuse/collection
VG	Trucks, topographic
VH	Trucks, tank
VI	Trucks, stake
VJ	Truck tractor (all types)
VK	Miscellaneous
VL	Passenger carrying vehicles
VM	Servicing platforms

**Table B-18**  
**Equipment category codes (ECC)—Continued**

VN	Trucks, multi purpose
VO	Trucks, panel
VP	Trucks, carryall
VQ	Trucks, cargo
VR	Trucks, utility
VS	Truck, sewage
VT	Trucks, other
VU	Trailers
VV	Semi-trailers
VW	Trucks, van
VX	Trucks, refrigeration
VY	Trucks, wrecker
VZ	Tools and testing equipment/Training Aids/Devices
W	Furniture And Appliances
WA	Desks
WB	Files
WC	Cabinets
WD	Rugs/curtains
WE	Ranges
WF	Refrigerators
WG	Frozen food displays
WH	Watercoolers
WJ	Musical related equipment
WK	Washing machines
WL	Dryers
WM	Laundry extractors
WN	Rotary files
WR	Davenport/couches
WS	Freezers
WT	Kitchen equipment
WU	Chairs
WV	Religious equipment
WW	Tables
WZ	Tools and test equipment/Training Aids/Devices
X	Office Equipment
XA	Safes
XB	Machines not listed elsewhere
XC	Typewriters
XD	Addressing plates
XE	Calculating
XF	Computing
XG	Time/payroll recorders
XL	Dictating

**Table B-18**  
**Equipment category codes (ECC)—Continued**

XM	Production control boards
XN	Drafting tables
XP	Flexo writers
XQ	Cash registers
XR	Sealing units
XU	Engravers
XV	Fabricators
XW	Endorsers
XX	Flag ceremonial
XY	Miscellaneous support equipment ADP
XZ	Tools and test equipment/Training Aids/Devices
Y	Tools Not Classified Elsewhere
YA	Aligning
YB	Collimators
YD	Saw Filers
YE	Multiple use gages
YF	Metalizing guns
YG	Hammers
YH	Jacks
YJ	Toolkits
YK	Lifts
YL	Special machines
YM	Pullers
YN	Riveters
YP	Toolsets
YQ	Wrenches
YR	Vises
YS	Dies
YT	Bore scopes
YU	Twisters
YW	Punches
YZ	Hose expanders
Z	Equipment Not Listed Elsewhere
ZA	Analyzers
ZB	Supporters
ZD	Stands
ZF	Stain/stress measuring
ZH	Springs
ZJ	Valves
ZK	Clothing
ZL	Textiles
ZM	Museum Equipment
ZN	Footwear

**Table B-18**  
**Equipment category codes (ECC)—Continued**

ZP	Tents/canvas
ZS	Miscellaneous
ZZ	Gym and sport equipment

**Table B-19**  
**The metric system and equivalents**

Symbol	When known	Multiply by	To find	Symbol
in	inches	2.5	centimeters	cm
ft	feet	30.0	centimeters	cm
yd	yards	0.9	meters	m
mi	miles	1.6	kilometers	km
mm	millimeters	0.04	inches in	in
cm	centimeters	0.4	inches in	in
m	meters	1.1	yards yd	ft
km	kilometers	0.62	miles mi	yd
<b>Mass (Weight)</b>				
oz	ounces	28.0	grams	g
lb	pounds	0.45	kilograms	kg
short tons (2000 lb)	0.9	tonnes	t	
g	grams	0.035	ounces	oz
kg	kilograms	2.2	pounds	lb
t	tons (1000 kg)	1.1	short tons	

**Table B-20**  
**Type maintenance request codes (Type MNT Req CD)**

Code	Description
1	Return to user. Maintenance actions need to be performed and the equipment returned to the user.
2	Modification Routine. A modification, special purpose alteration or special mission alteration is required to be applied on an item of equipment.
3	Modification emergency/urgent. An emergency/urgent modification or safety recall order is required to be applied on an item of equipment.
6	Cosmetic maintenance. Indicates body work, painting, and so on.
7	Sample data collection. Data provided by user in response to query by support maintenance.
8	Usage device change. Data recorded by customer unit to support unit upon change of a usage-recording device (miles, rounds, hours, kilometers).
9	Production. A work request applicable to more than one item, usually controlled by a maintenance control number, when a production-line type of operation may be applied.
A	Estimated cost of damages. A request for inspection to identify cost of repairs of a specific damage, as in an accident.
B	Army Working Capital Fund (AWCF) outsourcing, sub or alternate contracting. A request for an AWCF funded item utilizing an outsourced activity or a sub or alternate contractor source of repair for funding accountability.
C	Classification. A request for the performance of an inspection to determine the classification code for turn in to the supply system.
D	Reparable exchange. A request for the repair of items in support of a Reparable Exchange (RX) program.
F	Return to stock. A work request indicating periodic maintenance is required.



**Table B-20**  
**Type maintenance request codes (Type MNT Req CD)—Continued**

G	Army Working Capital Fund (AWCF) organic disassembly/reclamation/assembly. Disassembly of an existing asset to reclaim sub components for repair, restoration, conversion, or modification. Also used for assembling serviceable assets into a higher order assembly, i.e., wheel assembly.
H	Recall maintenance. Actions that can be identified and scheduled in advance.
I	AWCF contractor disassembly/reclamation/assembly. Disassembly of an existing asset to reclaim subcomponents for repair, restoration, conversion, or modification. Also used for assembling serviceable assets into a higher order assembly, for example, wheel assembly.
J	Component change. Data recorded by a customer unit upon change.
K	Oil-analysis recommendation. The maintenance request is being generated as the result of an oil-analysis laboratory recommendation.
L	AWCF reimbursable work order repaired by an organic labor force under a specialized repair authority.
M	Operation and Maintenance, Army funded work order repaired by an organic labor force under a specialized repair authority.
N	AWCF reimbursable work order repaired by a contractor labor force under a specialized repair activity.
O	Operation and Maintenance, Army funded work order repaired by a contractor labor force under a specialized repair authority.
P	AWCF organic repairable (GS). A request for the repair of an AWCF funded item by an organic GS labor force.
Q	AWCF organic repairable (DS). A request for the repair of an AWCF funded item by an organic DS labor force.
R	AWCF organic equipment change package with NSN change. A request for the modernization by an organic labor source which results in an NSN change.
S	AWCF organic equipment change package with no NSN change. A request for the modernization by an organic labor source which results in no NSN change.
T	AWCF contractor repairable (GS). A request for the repair of an AWCF funded item by a contractor GS labor source.
U	AWCF contractor repairable (DS). A request for the repair of an AWCF funded item by a contractor DS labor source.
V	AWCF contractor equipment change package with NSN change. A request for the modernization of an AWCF funded item by a contractor labor source which results in an NSN change.
W	AWCF contractor equipment change package with no NSN change. A request for the modernization of an AWCF funded item by a contractor labor source that results in no NSN change.
X	AWCF DS/GS military training support repair programs (annual training/developmental tests). This is to track items repaired by active duty and reserve component units (Camp Dodge, Fort Dix, Fort McCoy) annual training and inactive training.
Y	AWCF organic production verification/certification, pilot validation/verification, and special testing. A check to ensure that the requisite special tools, test equipment, skills, facilities, and parts are present to permit repair of an asset to the national standard. To perform special required test.
Z	AWCF contractor production verification/certification, pilot validation/verification, and special testing. A check to ensure that the requisite special tools, test equipment, skills, facilities, and parts are present to permit repair of an asset to the national standard. To perform special required test.

Notes:

<sup>1</sup> These codes are used to describe the maintenance action requested. These codes are applicable to DA Form 2407, block 5 (SAMS unique).

**Table B-21**  
**Work request status code**

Code	Description
A	Awaiting initial inspection. Includes initial inspection, acceptance, and parts determination. Code can be used at unit level. At support level, an "A" is usually entered first unless preceded by a "9".
B	In shop. Code can be used at unit level.
C	Awaiting shop. The initial and acceptance inspections have been completed and parts are on hand. Code can be used at unit level.
D	Deferred. Equipment in use, awaiting scheduled maintenance (may or may not be awaiting parts) and not considered high priority in that equipment is operating but requires some maintenance or modification. Codes can be used at unit level. Normally used in conjunction with a non-NMC ORG WON. Can be used with a NMC ORG WON if preceded by a "2".
E	Awaiting final inspection. Code can be used at unit level.
F	Final inspection complete. Includes final inspection and work order/log book completion. NMC time is charged to the owning unit until the NMC fault is corrected and a "U" status is posted at unit level.

**Table B-21**  
**Work request status code—Continued**

G	Test flight, or maintenance operational check. NMC time is charged to the owning unit until the NMC fault is corrected and a "U" status is posted at unit level.
H	Awaiting disposition instructions from a higher source.
I	Awaiting shop while awaiting non-NMC (not NMCS) parts. Cannot be used if due-in parts are NMCS. Code can be used at unit level. Normally used in conjunction with a non-NMC ORG WON. Can be used with a NMC ORG WON if preceded by a "2".
J	In shop awaiting NMCS parts, work continues. The calculation for NMCS/NMCM remains in NMCM. This code was designed for aircraft but may be used for other items requiring maintenance. Code can be used at unit level.
K	Awaiting non-NMC parts (not NMCS). No further repair actions can be made because the non-deadlining parts are not available. Normally used in conjunction with a non-NMC ORG WON. Can be used with a NMC ORG WON if preceded by a "2".
L	EVAC NMCS. Item that was evacuated to another maintenance activity for repair and return and is now in an NMCS status at the other activity. NMC time is applied to SUPPORT NMCS.
M	EVAC NMCM. Item evacuated to another maintenance activity for repair and return. Code can be used at unit level. NMC time is applied to support NMCM.
N	EVAC Depot. Equipment that is in a depot, or in for depot level repair, that is, overhaul/MWO is being performed. Code can be used at unit level. NMC time is applied to NMCD for ground/missile and aviation sub-system records and reportable end items. Aviation system records reflect PMCD.
O	Awaiting evacuation. Code can be used at unit level. Allows printing of automated DA Form 2407 at support level.
P	NMC for lack of: facility, tools, test equipment, or completion of intra-shop work requests.
Q	Awaiting estimated cost of damage (ECOD) actions. Items awaiting the release of surveying officer before repairs can be started.
R	Awaiting pickup. Item has been repaired (or appropriate action taken), and the owning unit has been notified. Before code "R" can be used, the work request must be closed. If item is NMC, NMC time is charged to the owning unit until the NMC fault is corrected and a "U" status is posted at unit level.
S	Closed, completed by this maintenance activity. Repairs have been completed by the support activity receiving the end item or component. Work request is closed. If item is NMC, NMC time is charged to the owning unit until the NMC fault is corrected and a "U" status is posted at unit level.
T	Closed, completed by other maintenance activity. Repairs have been completed and returned by the other activity to the support activity. Work request is closed. If item is NMC, NMC time is charged to the owning unit until the NMC fault is corrected and a "U" status is posted at unit level.
U	Picked up, must be closed first. Code can be used at unit level. At unit level . . . Closed the ORG WON. All related records on the Inoperative Equipment File are closed. All inoperative NMC time stops. At support level . . . Picked up by customer. The SPT WON and all related DS/GS work orders are deleted from SAMS-1 during the next weekly WO Transfer process.
V	Closed requirement satisfied by ORF exchange. Requires the new serial number. The SAMS-1 system automatically prompts the user for a new serial number. If item is NMC, NMC time is charged to the owning unit until the NMC fault is corrected and a "U" status is posted at unit level.
W	Work request closed. Pending turn-in as uneconomically repairable or nonrepairable (classification). If item is NMC, NMC time is charged to the owning unit until the NMC fault is corrected and a "U" status is posted at unit level.
X	Work request closed. It exceeds time limits or maintenance capability (for example, classification condition code F). If item is NMC, NMC time is charged to the owning unit until the NMC fault is corrected and a "U" status is posted at unit level.
Y	Work request closed. It did not meet acceptance standards. If the item is NMC, NMC time is charged to the owning unit until the NMC fault is corrected and a "U" status is posted at unit level.
Z	Work request closed or canceled without completion (for example, initial inspection was not started). If item is NMC, NMC time is charged to the owning unit until the NMC fault is corrected and a "U" status is posted at unit level.
0 (zero)	Begin NMCE time. Code used at unit level (system generated) and not entered by the user. ULLS unique code.
1	Awaiting deadlining NMCS parts. No further repairs can be made due to lack of NMCS parts. Code can be used at unit level.
4	Not used at this time.
5	Scheduled services. Carry equipment that is in shop for scheduled services... (weekly, Quarterly, semiannual, annual, and so on).
6	Re-inspection. Can only be used after a work request status code of 8rework.
7	Awaiting float transaction.
8	Rework, return to shop. If work request is "S" through "Z", an 8 must be used before the job is returned to a work status.

**Table B-21**  
**Work request status code—Continued**

9	Begin in-transit time
---	-----------------------

Notes:

<sup>1</sup> These codes indicate the status of a work request in the maintenance shops at all levels. These codes are applicable to all SAMS and ULLS forms which have a STA block. The following describes the usage and rules of each code:

**Table B-22**  
**Work request NMC indicator codes**

Code	Description
2	Stops NMC time. Item remains in the maintenance activity for non-NMC work, for example, painting. Must be followed by a valid work request status code.
3	Restart NMC time. Must be preceded by a "2" (which stops NMC time). Must be followed by a valid work request status code.

Notes:

<sup>1</sup> These codes are maintenance indicator codes that denote the NMC status of a work request in the maintenance shops. These codes are only used with work orders that have a "0" or "2" in the sixth position of the ORG WON that identify reportable inoperative equipment. A "0" denotes reportable ground or missile equipment, and "2" denotes reportable aircraft. These codes are applicable to all SAMS forms which have a STA block, and are intended to provide units and higher headquarters with timely AMSS status. These codes are SAMS unique and are not required for non-automated units.

**Table B-23**  
**NMC time for AMSS reporting**

Status Codes	Unit-Level ULLS				Support-Level SAMS			
	NMCM	NMCS	NMCD	NMCE	NMCM	NMCS	NMCD	FMC
A <sup>2</sup>	X				X			
B <sup>2</sup>	X				X			
C <sup>2</sup>	X				X			
D <sup>2</sup>								X
E <sup>2</sup>	X				X			
F <sup>2</sup>	X							X
G	X							X
H					X			
I <sup>2</sup>	X				X			
J <sup>2</sup>	X				X			
K					X			
L						X		
M <sup>2</sup>	X				X			
N <sup>2</sup>			X				X	
O <sup>2</sup>	X				X			
P					X			
Q					X			
R	X							X
S	X							X
T	X							X
U <sup>2</sup>								X
V	X							X
W	X							

**Table B-23**  
**NMC time for AMSS reporting—Continued**

Unit-Level ULLS					Support-Level SAMS			
Status Codes	NMCM	NMCS	NMCD	NMCE	NMCM	NMCS	NMCD	FMC
X	X							
Y	X							
Z	X							
0								
1 <sup>2</sup>		X		X		X		
2								
3								
4								
5								
6					X			
7					X			
8					X			
9	X							

Legend for Table B-23:

NMCM (Not Mission Capable Maintenance)

NMCS (Not Mission Capable Supply)

NMCD (Not Mission Capable Depot)

NMCE (Not Mission Capable Equipment)

Notes:

<sup>1</sup> These are the NMC categories for each Work Request Status Code. This chart only applies to inoperative equipment at the ULLS and SAMS level (NMC ORG WON work orders only). For example, STA code of "Q" is used at support level and counts NMCM downtime at support level only. STA code "S" stops NMC downtime at both levels unless the equipment is still inoperative at the unit level.

<sup>2</sup> Can be used at unit and support level.

**Table B-24**  
**Level of work codes**

Code	Description
O	Unit/AVUM
F	Direct Support/AVIM
H	General Support
D	Depot
K	Contractor
L	Special Repair Activity

**Table B-25**  
**Operational readiness float (ORF) transaction codes**

Transaction Code	Explanation
Issue of ORF Item	Demand
RORF Item for Repair	Demand
LDA ORF Item for Repair	Demand
ZORF Item Being Repaired	Not a Demand

Notes:

<sup>1</sup> These codes are machine generated in the SAMS-1 system.

## Appendix C Warranty Control offices and Logistics Assistance Offices

### C-1. Warranty control offices

This appendix lists warranty control offices and supporting logistics assistance offices (table C-1). These offices are listed to assist personnel submitting warranty claim actions (WCAs). The warranty control offices manage warranty programs at posts, camps, and stations in accordance with AR 700-139.

### C-2. Supporting logistics assistance offices

These offices assist in resolving warranty claim problems (table C-2).

**Table C-1  
Warranty control offices**

Command	Location/station	Address/phone
Commander, U.S. Army Reserve Command (USARC)	USARC	US Army Reserve Command ATTN: AFRC-LGM 1401 Deshler Street, SW Fort McPherson, GA 30330-2000 (404) 464-8095, DSN: 367-8095
USARC	63D regional support center (RSC)	Cdr, 63d Regional Support Command ATTN: AFRC-CCA-LGM PO Box 3002 Los Alamitos, CA 90720-1301 (562) 795-1340
USARC	65TH RSC	Cdr, 65th Regional Support Command ATTN: AFRC-CPR-LGM Building 1306C Fort Buchanan, PR 00934-7000 (787) 707-2276
USARC	70TH RSC	Cdr, 70th Regional Support Command ATTN: AFRC-CWA 4575 36th Avenue West Seattle, WA 98199-5000 (206) 301-2039
USARC	77TH RSC	Cdr, 77th Regional Support Command ATTN: AFRC-CNY-LGM Fort Totten Flushing, NY 11359-1016 (716) 671-6260
USARC	81ST RSC	Cdr, 81st Regional Support Command ATTN: AFRC-CAL-LGM 255 West Oxmoor Road Birmingham, AL 35209-6383 (205) 795-1528
USARC	88TH RSC	Cdr, 88th Regional Support Command ATTN: AFRC-CMN-LGM 506 Roeder Circle Fort Snelling, MN 55111-4009 (612) 713-3129
USARC	89TH RSC	Cdr, 89th Regional Support Command ATTN: AFRC-CKS-LGM 3130 George Washington Blvd Wichita, KS 67210-1598 (316) 681-1759 X1317
USARC	90TH RSC	Cdr, 90th Regional Support Command ATTN: AFRC-CAR-LGM 8000 Camp Robinson Road North Little Rock, AR 72118-2205 (501) 771-8970

**Table C-1  
Warranty control offices—Continued**

USARC	96THRSC	Cdr, 96th Regional Support Command ATTN: AFRC-CUT-LGM Bldg 103, Douglas AFRC Salt Lake City, UT 84113-5007 (801) 736-4865
USARC	99TH RSC	Cdr, 99th Regional Support Command ATTN: AFRC-CPA-LGM 99 Soldiers Lane Coraopolis, PA 15108-2550 (412) 604-8377

**Table C-2.  
Supporting logistics assistance offices**

Command	Location/Station	Address/phone/e-mail
Logistics support element (LSE)CONUS	Fort McPherson, GA	CDR, USAMC LSE-CONUS ATTN: MFSCN-COC 1777 HARDEE AVENUE SW FORT MCPHERSON, GA 30330-6000 DSN 367-7070/6711 COM (404) 464-7070/6711 EMAIL: lseconus@forscom.army.mil FAX: DSN 367-6750; COM (404) 464-6750
LSE101ST ABN	Fort Campbell, KY	CHIEF USLAO 101ST ABN ATTN: MFSC-CO-101 BLDG 2209 FORT CAMPBELL KY 42223-5000 DSN 635-6929/4510 COM (502) 798-6929/4510 EMAIL: laoftcam@emh2.campbell.army.mil FAX: DSN 635-3730; COM (502) 798-3730
LAO 13TH Corps Support Command (COS-COM)	Fort Hood, TX	CHIEF, USALAO, 13TH COSCOM ATTN: AMXLS-F-CO 1001 761ST TANK BN AVE, BLDG 4419 FORT HOOD, TX 76544-5072 DSN 737-9513/6608 COM (254) 287-9513/6608 E-MAIL: lao13coscom@hood-emh3.army.mil FAX: DSN 737-7917; COM (254) 287-7917
LAO 1ST CAV	Fort Hood, TX	CHIEF, USALAO, 1ST CAV ATTN: AMXLS-F-1C 1001 761ST TANK BN AVE, BLDG 4434 FORT HOOD, TX 76544-5070 DSN 737-6634 COM (254) 287-6634 E-MAIL: lao1cav@hood-emh3.army.mil FAX: DSN 737-5199; COM (254) 287-5199
LAO 1ST COSCOM	Fort Bragg, NC	CHIEF, USALAO, 1ST COSCOM ATTN: AMXLS-F-COS BLDG MT2645 FORT BRAGG, NC 28307-5000 DSN: 337-5262/3357 COM (910) 907-5262 E-MAIL: laocoscom@bragg.army.mil FAX: DSN 236-5588; COM (910) 907-5588
FT CARSON		CHIEF, USLAO FT CARSON ATTN: AMXLS-F-CR 4300 OCONNELL BLVD, ROOM 217 FORT CARSON, CO 80913-4003 DSN 691-9014 COM (719) 526-9014 EMAIL: amxlsfcr@logsa.army.mil FAX: DSN 691-2804; COM (719) 526-2804

**Table C-2.  
Supporting logistics assistance offices—Continued**

LAO 4TH ID	Fort Hood, TX	CHIEF, USLAO 4THID ATTN: AMXLS-F-4ID BLDG 4421, 1001 761ST TANK BN AVE FORT HOOD, TX 76544-5071 DSN 737-3103/2046 COM (254) 287-3103/2046 EMAIL: lao4id@hood.army.mil FAX: DSN 737-3843; COM (254) 287-3843
LAO 82ND ABN	Fort Bragg, NC	CHIEF, USLAO 82ND ABN ATTN: AMXLS-F-BG BLDG AT4924 FORT BRAGG, NC 28310-5000 DSN 236-5188/4004 COM (910) 396-5188/4004 EMAIL: lao-82@bragg.army.mil FAX: DSN 236-1900; COM (910) 396-1900
LAO FT BENNING	Fort Benning, GA	CHIEF, USLAO FT BENNING ATTN: AMXLS-F-BE 7208 BALTZELL AVE., BLDG 108 FORT BENNING, GA 31905-6225 DSN 8355617/5390 COM (706) 545-5617/5390 EMAIL: amxlsfbe@logsa.army.mil FAX: DSN 835-6019; COM (706) 545-6019
LAO FT BLISS	Fort Bliss, TX	CHIEF, USALAO, FT BLISS ATTN: AMXLS-F-BL BLDG 620, RM 13, TAYLOR ST. FORT BLISS, TX 79916-6218 DSN 978-1839 COM (915) 568-1839 EMAIL: amxlsfbl@logsa.army.mil FAX: DSN 978-2802; COM (915) 568-2802
FT DRUM	Fort Drum NY	CHIEF, USALAO, FORT DRUM ATTN: AMXLS-F-DR 124 FIRST STREET WEST FORT DRUM, NY 13602-5039 DSN 341-6829/6439 COM (315) 772-6829/6439/5309 EMAIL: amxlsfdr@logsa.army.mil FAX: DSN 341-4184; COM (315) 772-4184
FT EUSTIS	Ft. Eustis, VA	CHIEF, USALAO, FORT EUSTIS ATTN: MFSCN-CO-EU BLDG 1605 FORT EUSTIS, VA 23604-5535 DSN 826-1333/2206 COM (757) 878-1331/2206 EMAIL: amxlsfeu@logsa.army.mil FAX: DSN 927-1332; COM(757) 878-1332
FT GORDON	Ft. Gordon, GA	CHIEF, USALAO, FORT GORDON ATTN: MFSC-CO-GN BLDG 10507, 994 10th St. FORT GORDON, GA 30905-5664 DSN 786-5305 COM (706) 791-5305 EMAIL: laoftgor@emh.gordon.army.mil FAX: DSN 780-2296; COM (706) 878-2296
FT HUACHUCA	Fort Huachuca, AZ	CHIEF, USALAO, FORT HUACHUCA ATTN: MFSCN-CO-HU 448 CHRISTY AVE FORT HUACHUCA, AZ 85613-5000 DSN 879-6328 COMM (520) 538-6328 EMAIL: laofthua@hqasc.army.mil FAX: DSN 879-8257; COM (520) 538-8257

**Table C-2.  
Supporting logistics assistance offices—Continued**

FT IRWIN	Ft. Irwin, CA	CHIEF, USALAO, FORT IRWIN ATTN: MFSCN-CO-IR BLDG 502, LANGFORD LAKE RD FORT IRWIN, CA 92310-5011 DSN 470-5002 COMM (760) 380-5002 EMAIL: amxlsfir@logsa.army.mil FAX: DSN 470-4675; COM (760) 380-4675
FT KNOX	Fort Knox, KY	CHIEF, USALAO, FORT KNOX ATTN: MFSCN-CO-KN CHAMBERLAIN ST, BLDG 6579 FORT KNOX, KY 40121-0059 DSN 464-3953/1291 COM (502) 624-3953/1291 EMAIL: amxlsfkn@logsa.army.mil FAX: DSN 464-8326; COM (502) 624-8326
FT LEONARD WOOD	Ft. Leonard Wood, MO	CHIEF, USALAO, FORT LEONARD WOOD ATTN: MFSCN-CO-LW 2818 NEBRASKA AVE, BLDG 1549N FORT LEONARD WOOD, MO 65473-8933 DSN 581-0278 COM (573) 596-0278 EMAIL: laoftleo@logsa.army.mil FAX: DSN 581-0155; COM (573) 596-0155
FT LEWIS	Ft. Lewis, WA	CHIEF, USALAO, FORT LEWIS ATTN: AMXLS-F-LE MS 25, BOX 339500 FORT LEWIS, WA 98433-9500 DSN 357-5593/3327 COM (253) 967-5593/3327 EMAIL: laofl@lewis.army.mil FAX: DSN 357-7642; COM (253) 967-7642
FT POLK	Ft. Polk, LA	CHIEF, USALAO, FORT POLK ATTN: MFSCN-CO-PK 7015 RADIO RD FORT POLK, LA 71459-0928 DSN 863-2977/4505 COM (318) 531-2977/4505 EMAIL: amxlsfpk@logsa.army.mil FAX: DSN 863-4811; COM (318) 531-4818
FT RILEY	Ft. Riley, KS	CHIEF, USALAO, FORT RILEY ATTN: MFSCN-CO-RI BLDG 8100, RM A10 FORT RILEY, KS 66442-6828 DSN 856-5130 COM (785) 239-5130 EMAIL: laoftril@riley.army.mil FAX: DSN 856-5943; COM (785) 239-5943
FT RUCKER	Fort Rucker, AL	CHIEF, USALAO, FORT RUCKER ATTN: MFSCN-CO-RU BLDG 902T, QUARTERMASTER ROAD FORT RUCKER, AL 36362-5000 DSN 558-3472/2526 COM (334) 255-3472/2526 EMAIL: amxlsfru@logsa.army.mil FAX: DSN 558-9088; COM (334) 255-9088
FT SILL	Fort Sill, OK	CHIEF, USALAO, FORT SILL ATTN: MFSCN-CO-SL BLDG 2594, CURRIE RD FORT SILL, OK 73503-6800 DSN 639-4961/3765 COM (580) 442-4961/3765 EMAIL: amxlsfsl@logsa.army.mil FAX: DSN 639-4226; COM (580) 442-4226



**Table C-2.  
Supporting logistics assistance offices—Continued**

FT STEWART	Fort Stewart, GA	CHIEF, USALAO, FT STEWART ATTN: MFSCN-CO-31D 1086 WILLIAM H. WILSHIRE, STE 225 FORT STEWART, GA 31314-5024 DSN 870-5037/2935 COM (912) 767-5037/2935 EMAIL: amxlsfst@EMH5.stewart.army.mil FAX: DSN 870-8684; COM (912) 767-8684
KUWAIT	Camp Doha, Kuwait	CHIEF, USALAO, KUWAIT ATTN: MFSSW-LAO UNIT 69900, CAMP DOHA, KUWAIT APO, AE 09889-9900 DSN (318) 438-5570 COM 011-965-468-5770 E-MAIL: walkerw@exch.kuwait.army.mil FAX: DSN 318 438-5796
USASOC	Fort Bragg, NC	CHIEF, USALAO, USASOC ATTN: MFSCN-CO-SO BLDG D2004, MARION ST, RM 311 FORT BRAGG, NC 28310 DSN 239-7342 COM (910) 432-7342 E-MAIL: mamxlsfso@logsa.army.mil FAX: DSN 239-3843; COM (910) 432-3843
USARSO	Fort Sam Houston, TX	CHIEF, USALAO, USARSO ATTN: MFSCN-CO-PR BLDG 128 FT SAM HOUSTON, TX 78234 DSN 421-6373 COM (210) 295-6373 EMAIL: lao-usarso@usarso.army.mil FAX: DSN 421-6369; COM (210) 295-6369
XVIII ABN CORPS	Fort Bragg, NC	CHIEF, USALAO, XVIII ABN CORPS ATTN: AMXLS-F-E BLDG 11621, DYER ST FT BRAGG, NC 28310-5000 DSN: 236-8003 COM (910) 396-8003 E-MAIL: FAX: DSN 236-9843; COM (910) 396-9843
SAUDI ARABIA	Riyad, Saudi Arabia	CHIEF, USALAO, SAUDI ARABIA AMC LAOSWA UNIT 74009 APO, AE 09852 COM: (318) 435-8180 (318) 433-8649 (HOME) E-MAIL: lao@riyadh-emh5.army.mil FAX: (318) 435-8179
AMCEUROPE	SECKENHEIM GERMANY	CDR, LSEEUROPE ATTN: MFSCN-CO UNIT 29331 APO AE 09226 DSN (314) 375-6068 COM 011-49-621-487-6068 EMAIL: ecdr@hqamceur.army.mil FAX: DSN (314) 375-2066
V CORPS	HEIDELBERG GERMANY	CHIEF, USALAO, V COPRS ATTN: MFSCN-HD APO AE DSN: (314) 370-5454 COM 011-49-611-57-5454 EMAIL: lao3rdco@hqamceur.army.mil FAX: (314) 375-5422

**Table C-2.**  
**Supporting logistics assistance offices—Continued**

1ST ID	KITZINGEN GERMANY	CHIEF, USALAO, 11D ATTN: MFSEU-KA UNIT 26132 APO AE 09031 DSN: (314) 355-7363 COM 011-49-9321-305-7363 EMAIL: lao1id@hq.amceur.army.mil FAX: DSN (314) 355-8604; COM 011-49-9321-305-8604
21ST TSC	KAISERSLAUTERN GERMANY	CHIEF, USALAO, 21ST TSC ATTN: MFSEU-KA BLDG 3004, RM 213 APO AE 09263 DSN (314) 484-8592/8207 COM 011-49-631-413-8592/8207 EMAIL: amclao@hq.21tsc.army.mil FAX: DSN (314) 484-4604; COM 011-49-631-413-4604
3D COSCOM	WIESBADEN GERMANY	CHIEF, USALAO, 3D COSCOM ATTN: MFSEU-WC UNIT 29629 APO AE 09096 DSN: (314) 337-7035 COM 011-49-611-705-7035 EMAIL: lao3rdco@hq.amceur.army.mil FAX: DSN (314) 337-5292; COM 011-49-611-705-5292
5TH SIG	MANNHEIM GERMANY	CHIEF, USALAO, 5TH SIG CMD ATTN: MFSEU-MA CMR 421 APO AE 09056 DSN (314) 380-5442 COM 011-49-621-730-5417 EMAIL: lao5thsi@hq.amceur.army.mil FAX: DSN (314) 380-5416
69THADA BDE	GIEBELSTADT GERMANY	CHIEF, USALAO, 69TH ADA BDE ATTN: AMXEU-GI APO AE 09182-9998 DSN (314) 352-7277/7222 COM 011-49-9334-8-7277/7222 EMAIL: lao69thada@hq.amceur.army.mil FAX: DSN (314) 352-7280; COM 011-49-9334-8-7280
7TH ATC	VILSECK GERMANY	CHIEF, USALAO, 7TH ATC ATTN: AMXEU-VL UNIT 28038 APO AE 09112 DSN (314) 476-2865/2049 COM 011-49-9662-83-2865/2049 EMAIL: lao7that@hq.amceur.army.mil FAX: DSN (314) 476-2876; COM 011-49-9662-83-2876
LAO SETAF	VICENZA ITALY	CHIEF, USALAO, SETAF ATTN: AMXEV-VI UNIT 31401 APO AE 09630 DSN (314) 634-6190/6189 COM 011-39-0444-516190 EMAIL: laosetaf@hq.amceur.army.mil FAX: DSN (314) 634-6184; COM 011-39-0444-516184
LSE FWDBOSNIA	COMANCHE BASE BOSNIA	CHIEF, USALAO, BOSNIA ATTN: AMXEU-FWD-BOSNIA JTF APO AE 09789 DSN (314) 762-7545 COM 011- EMAIL: FAX: DSN (314) 762-7517; COM 011-

**Table C-2.  
Supporting logistics assistance offices—Continued**

AMC FWDFFE	CAMP MARKET BUPYONG, KOREA	CDR, AMC FWDFFE ATTN: SFSFE-CO-AMCOM BLDG 1530, CAMPMARKET UNIT 15293, APO AP 96283-5295 DSN (315) 722-3242 COM 011-82-32-520-6242 EMAIL: Knightaw@usfk.korea.army.mil FAX: DSN (315) 722-3072
AMC FWDFFE	CAMP MARKET BUPYONG, KOREA	DEPUTY TO THE COMMANDER, AMC FWDFFE/CHIEF, LOGISTICS ASSISTANCE OFFICE FAR EAST ATTN: SOSFS-F-CO BLDG 1530, CAMP MARKET UNIT 15293, APO AP 96283 DSN (315) 722-3222 COM 011-82-0505-722-6222 EMAIL: rutherfordw@usfk.korea.army.mil FAX: DSN (315) 722-3043
LAO, 19TH TSC	CAMP HENRY TAEGU, KOREA	CHIEF, USLAO, 19 <sup>TH</sup> TSC ATTN: SFSFE-CO BLDG T 1654 APO AP 96218-5016 DSN: (315) 768-7909 COM 011-82-53-470-7909 EMAIL: millsd@usfk.korea.army.mil FAX: DSN (315) 722-8034
LAO 25THID (L)	SCHOLFIELD BRKS HAWAII	CHIEF, USALAO, 25TH ID (L) ATTN: SFSFE-LAO-25ID 6043 EAST RANGE SCHOFIELD BARRACKS, HI 96857-5400 DSN: (315) 456-0876 COM (808) 656-0885 EMAIL: lao25id@schofield-emh1.army.mil FAX: DSN: (315) 456-0876; COM (808) 655-2359
LAO ALASKA	FT WAINWRIGHT ALASKA	CHIEF, USALAO, ALASKA ATTN: SFSFE-AK BLDG 1051, APT 1, 2, 3 FT WAINWRIGHT, AK 99703-0049 DSN (317) 353-2321 COM (907) 353-2321 EMAIL: laochief@wainwright.army.mil FAX: DSN (317) 353-2305; COM (907) 353-2305
LAO FT RICHARDSON	FT RICHARDSON ALASKA	CHIEF, USALAO, FT RICHARDSON ATTN: SOSFS-F-LAO-AL-FR BLDG 977, Room 207 FORT RICHARDSON, AK 99505 DSN: (317) 384-6333 COM (907) 384-6333 EMAIL: duartep@richardson-emh2.army.mil FAX: DSN (317) 384-6332; COM (907) 384-6332
LAO SEOUL	CAMP MARKET BUPYONG, KOREA	CHIEF, USALAO, SEOUL ATTN: SOSFS-F-LAO-S UNIT 15293 APO AP 96283 DSN (315) 722-3552 COM 011-82-32-520-6552 EMAIL: barrettc@usfk.korea.army.mil FAX: DSN (315) 722-3406

## Appendix D Julian/Ordinal Date Calendar

### D-1. Julian dates

Julian dates are made with four numerical characters. The first character of the Julian date is the last number of the current calendar year. The remaining three characters of the Julian date are the numbered calendar day of the current

year. For example, for 11 June 2001, the Julian date would be 1162. Using the date of 11 June 2001, instructions on how to arrive with a Julian date from the chart below are as follows:

a. For the first character of the Julian date, use the last numerical character of calendar year 2001. The one (1) is the first character of the Julian date for 2001.

b. For the remaining three characters of the Julian date, find the day of the month (in this case, 11 June) in the first or last column in the chart below. With a straight edge placed on the line where the day 11 appears, move to the right or left until the current month is located (in this case, June). The number 162 is found in the June column.

c. Place this 1 in front of 162; this provides the Julian date of 1162 for June 2001.

## D-2. Ordinal dates

Ordinal dates are made with five numerical characters. The first characters of the ordinal date are the last two numbers of the current year. The remaining three characters of the ordinal date are the numbered calendar day of the current year. For example, for 11 June 2001, the ordinal date would be 01162. Using the date of 11 June 2001, instructions on how to arrive with an ordinal date from the chart below are as follows:

a. For the first two characters of the ordinal date, use the last two numerical characters of calendar year 2001. The 01 is the first two characters of the ordinal date for 2001.

b. For the remaining three characters of the ordinal date, find the day, month, and numeric day if the calendar year 2001, the same way as for the construction of the Julian date (para D-1). The ordinal date for this example of 11 June 2001 is 01162.

c. For both numeric date use the table D-1 to determine the correct Julian/Ordinal date (see AR 725-50, table 3-1).

**Table D-1**  
**Julian/ordinal date calendar (perpetual)**

Day	Jan	Feb	Mar	Apr	May	Jun	Jul	Aug	Sep	Oct	Nov	Dec	Day
1	001	032	060	091	121	152	182	213	244	274	305	335	1
2	002	033	061	092	122	153	183	214	245	275	306	336	2
3	003	034	062	093	123	154	184	215	246	276	307	337	3
4	004	035	063	094	124	155	185	216	247	277	308	338	4
5	005	036	064	095	125	156	186	217	248	278	309	339	5
6	006	037	065	096	126	157	187	218	249	279	310	340	6
7	007	038	066	097	127	158	188	219	250	280	311	341	7
8	008	039	067	098	128	159	189	220	251	281	312	342	8
9	009	040	068	099	129	160	190	221	252	282	313	343	9
10	010	041	069	100	130	161	191	222	253	283	314	344	10
11	011	042	070	101	131	162	192	223	254	284	315	345	11
12	012	043	071	102	132	163	193	224	255	285	316	346	12
13	013	044	072	103	133	164	194	225	256	286	317	347	13
14	014	045	073	104	134	165	195	226	257	287	318	348	14
15	015	046	074	105	135	166	196	227	258	288	319	349	15
16	016	047	075	106	136	167	197	228	259	289	320	350	16
17	017	048	076	107	136	168	198	229	260	290	321	351	17
18	018	049	077	108	138	169	199	230	261	291	322	352	18
19	019	050	078	109	139	170	200	231	262	292	323	353	19
20	020	051	079	110	140	171	201	232	263	293	324	354	20
21	021	052	080	111	141	172	202	233	264	294	325	355	21
22	022	053	081	112	142	173	203	234	265	295	326	356	22
23	023	054	082	113	143	174	204	235	266	296	327	357	23
24	024	055	083	114	144	175	205	236	267	297	328	358	24
25	025	056	084	115	145	176	206	237	268	298	329	359	25

**Table D-1**  
**Julian/ordinal date calendar (perpetual)—Continued**

26	026	057	085	116	146	177	207	238	269	299	330	360	26
27	027	058	086	117	147	178	208	239	270	300	331	361	27
28	028	059	087	118	148	179	209	240	271	301	332	362	28
29	029		088	119	149	180	210	241	272	302	333	363	29
30	030		089	120	150	181	211	242	273	303	334	364	30
31	031		090		151		212	243		304		365	31

Notes:

<sup>1</sup> For Leap year add one to year date after 28 February.

## Appendix E

### Department of the Army List of Items on Which Historical Records are to be Maintained

#### E-1. Introduction

This appendix explains which equipment requires historical records and which forms to keep. These records and forms represent required data elements and a unique relationship to either the end item or the component. The Army uses web-based databases, AIT devices, and business process redesign to transition from a form-based maintenance system to a digitized process-based maintenance system in support of TAMMS. In addition to required forms listed in this appendix, DA Form 2408-20 is maintained on equipment enrolled in the AOAP. The AOAP equipment is identified in TB 43-0211. However, if the supporting AOAP laboratory is automated and printout(s) or automated forms are received reflecting all the data from DA Form 2408-20, DA Form 2408-20 is not required unless directed by local standing operation procedures.

#### E-2. Forms

*a. Required.* Required forms are identified opposite the nomenclature of the equipment found in tables E1 through E4. DA Form 2408-9 A/T/G/L refers to reporting of acceptance, transfers, losses, gains, and NSN redesignations. DA Form 2408-9 USAGE refers to usage. DA Form 2408-9 OVHL refers to overhaul reporting, and to the repair of selected combat and tactical vehicles under the CONUS Tactical Wheeled Vehicle Program and for outside the continental United States, under the Theater Intermediate General Support Repair Program (formerly The Theater Army Repair Program), or other DA-approved programs requiring DA Form 2408-9 reports. All track and wheeled items of equipment subject to the U.S. Army Vehicle Registration Program are required to submit DA Forms 2408-9 per chapter 5 of both AR 710-3 and this pamphlet. These items have been included in appendix E of this publication. When AIT devices are embedded on end items and components and can be leveraged by the GCSSA Maintenance Module, paper-based form requirements listed in this section are no longer required.

*b. Forms information.* The purpose, detailed requirements, use, preparation, processing and disposition of DA forms are contained in other chapters of this pamphlet.

*c. TAMMS DA Forms.* Commanders may direct the preparation of TAMMS DA forms not listed for equipment for local management purposes. However, all copies of forms used is retained within the command.

*d. Initiation of DA Form 2408-5.* DA Form 2408-5 is initiated only upon notification of the first published DAMWO.

*e. When to start a form.* Do not start a form until entries are required on it.

#### E-3. Missile systems/missile subsystems, combat/tactical vehicles, and support equipment

Missile systems/missile subsystems, combat/tactical vehicles, and support equipment are listed in figures E-1 and E-2 and arranged by ECC. The column headings are ECC, NOUN, MODEL, LIN, NSN, EIC, REG# REQD, and FORMS REQUIRED. The ECC is a two character alpha designation that shows the general and groupings for the items (see table B-18).

#### E-4. Railway equipment and nontactical wheeled vehicles

Railway equipment and nontactical wheeled vehicles are listed in figures E-3 and E-4 and are arranged by ECC/LIN/NSN. The column headings are ECC, NOUN, LIN, NSN, EIC, REG# REQD, and FORMS REQUIRED.

#### E-5. Requests to add equipment

Requests to add equipment to appendix E is submitted in writing through the AMC major subordinate command that manages the item to: Commander, USAMC Logistics Support Activity, ATTN: AMXLS-MD, Redstone Arsenal, AL

35898-7466. The command that manages the item can be found by looking up the item's NSN on the Army Master Data File. The command is identified by the first position of the MATCAT code.

- a. Request to add equipment includes the following information:
  - (1) The nomenclature of the item.
  - (2) The item's NSN.
  - (3) Model or identification number.
  - (4) Line item number.
  - (5) Item manager (the command that manages the item).
  - (6) The item's equipment category code (see table B-18).
  - (7) Is the item currently in the Army inventory? Give the current and projected densities. (Normally the command that manages the item provides this information.)
  - (8) Identify the type of historical records required.
  - (9) Define the purpose of each form to include—
    - (a) Data to be collected.
    - (b) Who uses the data.
    - (c) How long the data must be retained and why.
    - (d) A picture of the equipment.
- b. Request for DA Form 2408-9 information—
  - (1) Defines the use and purpose for DA Form 2408-9 data being requested.
  - (2) Defines the data elements required for summaries/reports that must be made on DA Form 2408-9 data that will be collected. Describe the required format for the intended summaries/reports.
  - (3) Identifies the frequency for the intended summaries/reports and the activity that is responsible for using the data.

#### **E-6. Usage reporting**

Usage reporting for all combat and selected tactical vehicles has been deleted. Usage for these items is now being obtained through the AOAP. Tactical vehicles not enrolled in the AOAP are still identified in appendix E as DA Form 2408-9 USAGE reportable and is reported as of 1 November of each year. Units with ULLS-G are required to report usage to LOGSA monthly through ULLS-G using the AMSS end-of-period report process on all equipment with an X in the columns labeled "24089 USAGE" or "DD2026 USAGE" in figures E-1 through E-4.

#### **E-7. Figure legend**

The legend for these figures is shown below:

- a. *ECC*. Equipment category code.
- b. *NOUN*. Nomenclature.
- c. *MODEL/LIN*. Model—End item model; LIN—Line item number.
- d. *NSN*. National stock number.
- e. *EIC*. End item code (\*\* indicates not assigned).
- f. *REG# REQD*. Indicates items requiring the assignment of U. S. Army registration numbers.
- g. *Forms required*. These are indicated by an X

ECC NOUN	MODEL	LIN	NSN	EIC	REG #	2408-4	2408-5	2408-9	2408-9	DD2026	2408-9
					REQ	WPNS REC	MWO	A/T/L/G	USAGE	USAGE	OVHL
<b>B AIR DEFENSE SYSTEM</b>											
<b>BF ARMAMENT SUBSYSTEM HELICOPTER M-22</b>											
TRAINING SET GM FC	DX-44	X04347	6920009539965				X	X			
<b>BK CHAPARRAL</b>											
GM INTERCEPT AERIAL	MIM-72B	J95467	1410004211632	NBP				X			
GM INCP AER (CHAP)	MIM-72C	J95469	1410005556185	NAH				X			
GM INTERCEPT AERIAL	MIM-72A	J95459	1410009308358	NAL				X			
GM INTERCEPT AERIAL	MIM-72E	M44599	1410010953248	NBG				X			
GM INTERCEPT AERIAL	MIM-72G	G95537	1410012057186	NAR				X			
TOWED CHAP FIRE UNIT	XM85	T69778	1425011662187	NCE	X			X			
GMS INCP AER (CHAP)	M48A1	J95533	1440010698877	NBD	X		X	X	X	X	
LAUNCHING STATION GMS	M54A1	J95536	1440010746799	NCH				X			
GMS INTERCEPT AERIAL	NONE	J95533	1440011063089	NBK	X		X	X	X	X	
LAUNCHING STATION GMS	NONE	J95536	1440011424576	NAQ				X			
GMS INTERCEPT AERIAL	M48A2E1	J95533	1440011985892	NCI	X		X	X	X	X	X
LAUNCHING STATION GMS	M54A2E1	J95536	1440012073002	NBQ				X			
GUIDED MISSILE SYS	M48A3	J95533	1440013203843				X	X		X	X
CARRIER GM EQUIP-CHAP	M730	D11668	1450009308749	NCF	X			X	X	X	X
TEST SET GM (CHAP)	AN/DSM79	V78928	4935000457282	NAC				X			
SHOP EQUIP GMS (CHAP)	AN/TSM96	T14441	4935001689951	NAE	X			X			
SHOP EQUIP GMS (CHAP)	ANTSM95	T14440	4935001689970	NAF	X			X			
TEST SET GMS (CHAP)	AN/TSM85	V79469	4935001987773	NAG				X			
ALIGNMENT SET (CHAP)	M-71	A35027	4935009338823	NAM				X			
SHOP EQUIP GMS (CHAP)	ANTSM96A	T14441	4935011049827	NBJ	X			X			
<b>BL DATA COVERTER AIR DEFENSE SYSTEM</b>											
RADAR SET	SENTINEL	G92997	1430014208077	NDA				X	X		
COMMAND SYSTEM TACT	JTAGS	C40746	5895014171880	NTA				X	X		

Figure E-1. Identification of required forms for missile systems

ECC NOUN	MODEL	LIN	NSN	EIC	REG #	2408-4	2408-5	2408-9	2408-9	DD2026	2408-9
					REQ	WPNS REC	MWO	A/T/L/G	USAGE	USAGE	OVHL
<b>BM LIGHT SPECIAL DIVISION INTERIM SENSOR (LSDIS)</b>											
DISPLAY SET (FAAR)	GSQ137	G22933	1430001795321	NFD			X	X			
DISPLAY SET (FAAR)	ANGSQ137	G22933	1430010687642	NFE			X	X			
RADAR SET	NONE	L60078	1430013477673	NVA				X	X		
TEST SET RADAR (FAAR)	AN/MPM59	V84002	6625001511323	NFA			X	X			
<b>BN STINGER</b>											
AVENGER	AN/TWQ-1	F57713	1430012861314	NWA	X		X	X	X		
AVENGER GM	AN/TWQ-1	F57713	1430013786963	NWC	X		X	X	X		
AVENGER, AIRDROP	NONE	F57713	1430014091965	NWB	X		X	X	X		
AVENGER FIRE UNIT-V	NONE	NO-LIN	1430014907031	***	X			X	X		
INTERROGATER ST-STINGER	AN/PPX-3	J98501	5895010324263	IZH				X			
PROG INT ST (STINGER)	NONE	P69002	5895010324266	IZJ				X			
IFF INT	PPX/3B	J98501	5895011269263	IZF				X			
BATTERY CHARGER-STING	NONE	C99921	6130010246922	NRB				X			
TRNG ST GMS (STINGER)	M134	T04834	6920010246948	NRF				X			
RECHARGING UT (STING)	M80	R61270	6920010249970	NRJ				X			
TRAINING SET GM	M160	T04834	6920012322562	NRV				X			
<b>BP PATRIOT</b>											
GM INCP AER	MIM-104A	G95535	1410010876343	MNE			X	X			
GM INCP AER	NONE	G95535	1410012057066	MNL			X	X			
GM INCP AER	NONE	G95535	1410012676685	MOV			X	X			
GUIDED MISSILE INTE	MIM-104C	G95535	1410012869689				X	X			
RADAR SET (PATRIOT)	NONE	R18815	1430010876330	MNA	X		X	X			
INFOR/COORD (PATRIOT)	ANMSQ116	J82250	1430010876337	MNB			X	X			
ENGAGE CTRL (PATRIOT)	ANMSQ104	E08497	1430010876338	MNC			X	X			
LNCHG STA (PATRIOT)	M901	L46979	1440010879844	MNF	X		X	X			
STRLR RPR PTS-PATRIOT	M1033	S74055	2330010879857	MNG	X		X	X			
STRLR VAN GM RPR PTS	PATRIOT	S43871	2330011307980	MNJ	X		X	X			
SHOP EQUIP GMS	ANTSM163	S17120	4935011348713	MOB			X	X			

Figure E-1. Identification of required forms for missile systems—Continued

ECC NOUN	MODEL	LIN	NSN	EIC	REG # REQ	2408-4 WPNS REC	2408-5 MWO	2408-9 A/T/L/G	2408-9 USAGE	DD2026 USAGE	2408-9 OVHL
SHOP EQUIP (PATRIOT)	ANTSM164	S15457	4935011360233	MOC	X		X	X			
SHOP EQUIP GM	ANTSM176	S14637	4935011654224	MON			X	X			
SHOP EQUIP GMS	AN/TCM-1	S14569	4935011820578	MOK	X		X	X			
ORG MAINT TRNR	NONE	F24234	6920011618962	MOD			X	X			
OPERATOR TACTICS TRNR	ANFSG-T2	T07252	6920011618963	MOE			X	X			
<b>BU GUIDES MISSILE SYSTEMS</b>											
GUIDED MISSILE BATT	NONE		1430014192235					X			
<b>BV MISCELLANEOUS</b>											
ANTENNA MAST GROUP	OE349MRC	A80593	1430011315373	MNK	X		X	X			
COMMUN RELAY GROUP	ANMRC137	C60363	1430011315427	MOA			X	X			
LAUNCHER GM	NONE		1440006268285					X			
PANEL STATUS	NONE		1440006292462					X			
CONTROL SIGHT UNIT	NONE		1440006292665					X			
INDICATOR PILOT STE	NONE		1440010307338					X			
PANEL TOW CONTROL	NONE		1440010321311					X			
SHOP EQUIP KIT (PVS)	XM-1		4935010122845	MCF	X		X	X			
AMPLIFIER ELECTRIC	NONE		6110006253738					X			
POWER SUPPLY	NONE		6130006253744					X			
<b>BX TRAINING AND HANDLING EQUIPMENT</b>											
TRAINING SET GM FC	DX-43	X04073	6920009539964				X	X			
<b>BZ TOOLS AND TEST EQUIPMENT/TRAINING AIDS/DEVICES</b>											
GM BATTERY	AN/TSW2		1430007143316					X			
GM BATTERY	AN/MSW-9		1430008329353		X			X			
TEST EQUIP	ANMPM44A	V60901	4935004745273		X			X			
<b>C MISSILE SYSTEMS LAND COMBAT</b>											

Figure E-1. Identification of required forms for missile systems—Continued

ECC NOUN	MODEL	LIN	NSN	EIC	REG # REQ	2408-4 WPNS REC	2408-5 MWO	2408-9 A/T/L/G	2408-9 USAGE	DD2026 USAGE	2408-9 OVHL
<b>CA LAND COMBAT SUPPORT SYSTEM (LCSS)</b>											
SUPPL EQUIP TEST STA	MK-1551	U59407	4935001347730	QRC			X	X			
SUPP EQUIP (LCSS)	MK1165	U59250	4935001779498	QRD			X	X			
TEST STA GMS (LCSS)	AN/TSM93	W00869	4935009307250	QRF			X	X			
SHOP EQ	AN/TSM94	T14485	4935009307251	QRG			X	X			
<b>CB TOW</b>											
CARR GM EQ LE WPN	NONE	D11681	1450001762697	AEA	X		X	X	X	X	X
TRK GM EQ MULE	NONE	X45554	1450001762709	BGA	X			X	X		
TRK GM EQ JEEP	NONE	X45549	1450001762712	BAA	X		X	X	X		X
TRUCK GUIDED MISSILE	10398963	X45317	1450008789024	BAB	X		X	X	X		X
FIELD TEST SET	TSM-140A	T79200	4935010703426	PAJ			X	X			
FIELD TEST SET	TSM-140B	T79200	4935011429561	PBJ			X	X			
BATTERY CHARGER (TOW)	PP4884AT	D99860	6130010189786	PAH				X			
<b>CD DRAGON</b>											
NIGHT VISION SGT TRAC	AN/TAS-5	N23721	1430010469594	PKF			X	X	X		
CMD LAUN UNIT	JAVELIN	C60750	1430014108545				X	X	X		
CMD LAUN UNIT	JAVELIN	C60750	1430014338025				X	X	X		
TRACTOR TEST SET	AN/TSM-114		4935000782858				X	X	X		
SUPP EQUIP (DRAGON)	MK1138	U59424	4935001093365	QRB			X	X			
TRACTOR TEST SET	AN/TSM-114		4935001245585	PJE			X	X	X		
TRANSM SET INFRARED	M89	X18673	6920000714482	PJA			X	X	X		
MONITORING SET GM	AN/TSQ-T1	M66857	6920001656369	PJH			X	X	X		
TRAINER LAUNCH EFF GM	M54	X00233	6920001756327	PJK			X	X	X		
TRANSM SET INFRARED	M89E1	X18673	6920011477124	PLB			X	X	X		
<b>CG MULTIPLE ROCKET LAUNCHER SYSTEM (MLRS)</b>											
LNCHR RKT ARMD (MLRS)	M270	L44894	1055010920596	QAC			X	X	X	X	X
LNCHR RKT ARMD (MLRS)	M270/IMP	L44894	1055011920357	QBD			X	X	X	X	X

Figure E-1. Identification of required forms for missile systems—Continued



ECC NOUN	MODEL	LIN	NSN	EIC	REG #	2408-4	2408-5	2408-9	2408-9	DD2026	2408-9
					REQ	WPNS REC	MWO	A/T/L/G	USAGE	USAGE	OVHL
AMVR LCHNR (MLRS)	M270/IMP	L44894	1055011920358	QBE			X	X	X	X	X
LNCHR RKT ARMD (MLRS)	M270	L44894	1055012519756	QBJ			X	X	X	X	X
LNCHR RKT ARMD (MLRS)	M270	L44894	1055013296826	QBU	X		X	X	X	X	X
LNCHR RKT ARMD (MLRS)	M270A1		1055014504243		X		X	X	X		
LNCHR RKT (HIMARS)	M142	H53326	1055014734350		X		X	X	X		
ROCKET POD 298MM	M26	L65871	1340011223506	QAH			X	X	X		
HYDRAULIC SVC UNIT	MLRS	H58029	1450011374442	QBA			X	X	X		
TRNR INERT LNCH POD	LP/CMLRS	T06763	6920011369550	QAJ			X	X	X		
TRNR INERT LNCH POD	M/LPA MLRS	T06763	6920012992216	QAM			X	X	X		
DIGITAL MSG DEVICE	MLRS	M52900	7025011936603	QAL			X	X	X		
<b>CH HELLFIRE</b>											
LNCHR GM AIRCRAFT	M272	L44830	1440011228965	QHA				X	X		
LNCHR GM AIRCRAFT	M279	L44830	1440013429878	QHK				X	X		
LNCHR GM AIRCRAFT	M299	L67410	1440013936361	QHT				X	X		
TEST SET GMS	AN/TSM-205	G95863	4935013936351					X	X		
<b>CL LANCE</b>											
LNCHR GM (LANCE)	M752	L44644	1440009370938	QEB	X			X	X	X	X
CARRIER GM	XM667E1		1450008793380		X			X	X		X
LDR TRANS GM (LANCE)	M688A1	L76750	1450009370939	QFJ	X			X	X	X	X
<b>CV GM SYSTEM SHILLELAGH</b>											
TEST SET GM	AN/TJM-1	V78911	4935001340056	QQB			X	X	X		
SUPP EQUIP-SHILLELAGH	MK1166	U59255	4935001779502	QRE			X	X			
SHOP EQUIP (COF)	AN/MSM-97	T10129	4935001795584	QQV			X	X	X		
TRNR LNCHR (COF)	M62	X00250	6920009304009	QQG			X	X	X		
<b>CX TRAINING AND HANDLING EQUIPMENT</b>											
TRAINING SET GM STM	M70	X04584	6920001797320	PAE			X	X	X		
TRAINING SET	AN/TAS-4	X04584	6920011439406	PBK			X	X	X		

Figure E-1. Identification of required forms for missile systems—Continued

ECC NOUN	MODEL	LIN	NSN	EIC	REG #	2408-4	2408-5	2408-9	2408-9	DD2026	2408-9
					REQ	WPNS REC	MWO	A/T/L/G	USAGE	USAGE	OVHL
<b>CY MISCELLANEOUS</b>											
BATTERY	BB-433/U		6140007532251						X		
<b>CZ TOOLS AND TEST EQUIPMENT/TRAINING AIDS/ DEVICES</b>											
ELECTRONIC SHOP	AN/TSM-191	T92961	4940013241505	KIF	X				X		

Figure E-1. Identification of required forms for missile systems—Continued

ECC NOUN	MODEL	LIN	NSN	EIC	REG #	2408-4	2408-5	2408-9	2408-9	DD2026	2408-9
					REQ	WPNS REC	MWO	A/T/L/G	USAGE	USAGE	OVHL
<b>D ARTILLERY WEAPONS</b>											
<b>DA TOWED HOWITZERS</b>											
HOWITZER LT 105MM	M102		K57392	1015000868164	3EA	X	X		X		
HOWITZER LT 105MM	M101		K57392	1015003229728	3EB	X	X		X		
HOWITZER LT 105MM	M101A1		K57392	1015003229752	3EC	X	X		X		
HOWITZER LT 105MM	M119		H57505	1015012480859	3FA	X	X		X		
HOWITZER LT 105MM	M119A1		H57505	1015013081872	3WC	X	X		X		
HOWITZER MED 155MM	M114		K57803	1025003229755	3EG	X	X		X		
HOWITZER MED 155MM	M114A1		K57803	1025003229768	3EH	X	X		X		
HOWITZER MED 155MM	M114A2		K57803	1025010259857	3EK	X	X		X		
HOWITZER MED 155MM	M198		K57821	1025010266648	3EL	X	X		X		
<b>DB MORTARS</b>											
MORTAR 120MM TOWED	XM120		M68405	1015012261672	4SL	X	X		X		
MORTAR 120MM CARRIER	M121		M68405	1015012923801	4SE	X	X		X		
<b>DE LNCHR MINE CLEARING</b>											
LNCHR ROCKET, 155MM	M91		L45123	1055006759532	4RC		X		X		
MINE CLEAR LNCHR	MICLIC		L67342	1055012035883	556	X			X		
LNCHR MINE CLEARING	MOD1		L67342	1056012812770	59A	X			X		
MINE CLEAR LNCHR MOD3	MK155M2		L67342	1055013273106	5UK				X		
MINE CLEAR LNCHR MOD2	MK155M2		L67342	1055013406084	5UJ	X			X		
<b>DG ANTI-AIRCRAFT GUNS</b>											
GUN ADA TOWED 20MM	M167A1		J96845	1005010140837	3JA	X	X		X		
<b>DH DISPENSER, MINE</b>											
DISPENSER, MINE	M57		A83602	1095001690300	3UF	X			X		
DISPENSER, MINE	M128		D20529	1095003973456	3UA	X			X		

Figure E-2. Identification of required forms for combat/tactical vehicles and support equipment

ECC NOUN	MODEL	LIN	NSN	EIC	REG #	2408-4	2408-5	2408-9	2408-9	DD2026	2408-9
					REQ	WPNS REC	MWO	A/T/L/G	USAGE	USAGE	OVHL
DISPENSER, MINE	M139		D30897	1095012353139	3V8				X		
<b>F TANKS</b>											
<b>FB 90MM, 105MM, 120MM</b>											
TANK COMBAT FT 105MM	M60A1R		V13101	2350001169765	ABA	X	X		X	X	X
TANK COMBAT FT 105MM	M60A3		V13101	2350001486548	ABB	X	X		X	X	X
TANK COMBAT FT 105MM	M48A5		V13101	2350005825595	ABC	X	X		X	X	X
TANK COMBAT FT 105MM	M60		V13101	2350006785773	ABD	X	X		X	X	X
TANK COMBAT FT 105MM	M60A1		V13101	2350007568497	ABE	X	X		X	X	X
TANK COMBAT FT 105MM	M60A1AOS		V13101	2350010589487	ABH	X	X		X	X	X
TANK COMBAT FT 105MM	M60A1RP		V13101	2350010591503	ABJ	X	X		X	X	X
TANK COMBAT FT 105MM	M48A5		V13101	2350010591504	ABK	X	X		X	X	X
TANK COMBAT FT 105MM	M60A3TTS		T13169	2350010612306	ABL	X	X		X	X	X
TANK COMBAT FT 105MM	M1		T13374	2350010612445	AAA	X	X		X	X	X
TANK COMBAT FT 120MM	M1A1		T13168	2350010871095	AAB	X	X		X	X	X
TANK COMBAT FT 105MM	M11P		T13374	2350011368738	AAC	X	X		X	X	X
TANK COMBAT FT 120MM	M1A2		T13305	2350013285964	AAF	X	X		X	X	X
<b>FC 90MM, 105MM, 120MM</b>											
TANK COMBAT FT 152MM	M60A2		V13270	2350009303590	ABG	X	X		X		X
<b>G COMBAT VEHICLES</b>											
<b>GA SELF-PROPELLED HOWITZERS</b>											
HOWITZER MED SP 8IN	M110		K56981	2350004396243	3E4	X	X		X	X	X
HOWITZER MED SP 155MM	M109		K57667	2350004408811	3ER	X	X		X	X	X
HOWITZER LT SP 105MM	M52		K57256	2350007333216	3EV	X	X		X	X	X
HOWITZER HVY SP FT	M110A1		K56981	2350010133914	3E5	X	X		X	X	X
HOWITZER MED SP 155MM	M109A2		K57667	2350010310586	3EZ	X	X		X	X	X
HOWITZER MED SP 155MM	M109A3		K57667	2350010318851	3E2	X	X		X	X	X

Figure E-2. Identification of required forms for combat/tactical vehicles and support equipment—Continued

ECC NOUN	MODEL	LIN	NSN	EIC	REG # REQ	2408-4 WPNS REC	2408-5 MWO	2408-9 A/T/L/G	2408-9 USAGE	DD2026 USAGE	2408-9 OVHL
HOWITZER HVY SP 8 IN	M110A2	K56981	2350010414590	3E3	X	X		X	X	X	X
HOWITZER MED SP 155MM	M109A4	K57667	2350012775770	3E8	X	X		X	X	X	X
HOWITZER SP FT 155MM	M109A5	K57667	2350012811719	3E7	X	X		X	X	X	X
HOWITZER MED SP	M109A6	H57642	2350013050028	3FC	X	X		X	X	X	X
<b>GB SELF-PROPELLED MORTARS</b>											
CARR MORTAR FT 107MM	M125A1	D10726	2350000710732	AEE	X	X		X	X	X	X
CARR MORTAR SP 107MM	M106A1	D10741	2350000769002	AEF	X	X		X	X	X	X
CARR MORTAR FT 81MM	M125A2	D10726	2350010684087	AEP	X	X		X	X	X	X
CARR MORTAR SP 107MM	M106A2	D10741	2350010696931	AER	X	X		X	X	X	X
CARR MORTAR SP 120MM	M1064	C10990	2350013383116	AE4	X	X		X	X	X	X
CARR MORTAR SP 120MM	M1064A3	C10990	2350013696082	AE8	X	X		X	X	X	X
<b>GC COMBAT VEHICLE, ANTI-TANK</b>											
COMBAT VEHICLE ITV	M901	E56896	2350010451123	AEM	X			X	X	X	X
COMBAT VEHICLE ITV	M901A1	E56896	2350011035641	AEV	X			X	X	X	X
COMBAT VEHICLE ITV	M901A3	E56896	2350013697253	L5Z	X			X	X	X	X
<b>GD SELF-PROPELLED GUNS</b>											
GUN AIR DEF ARTY SP	M247	G96572	2350010891261	3JK	X			X	X	X	X
<b>GF RECOVERY VEHICLES</b>											
RECY VEH FT MED	M88A1	R50681	2350001226826	AQA	X			X	X	X	X
RECY VEH FT LT ARMD	M578	R50544	2350004396242	3LA	X			X	X	X	X
RECY VEH FT HVY	M88A2	R50885	2350013904683	AQC	X			X	X	X	X
<b>GG COMBAT ENGINEER VEHICLES</b>											
COMBAT ENGR VEH FT	M728	E56578	2350007951797	ABF	X	X		X	X	X	X
<b>GJ TRACTORS</b>											
TRCTR FT HIGH SPEED	M9 (ACE)	W76473	2350008087100	ASA	X			X	X	X	X

Figure E-2. Identification of required forms for combat/tactical vehicles and support equipment—Continued

ECC NOUN	MODEL	LIN	NSN	EIC	REG # REQ	2408-4 WPNS REC	2408-5 MWO	2408-9 A/T/L/G	2408-9 USAGE	DD2026 USAGE	2408-9 OVHL
<b>GK LAUNCHER, BRIDGE</b>											
CARRIER BRIDGE LNCHR	M48A2	L43390	5420005423052	ARB	X	X		X	X	X	X
CARRIER BRIDGE LNCHR	M60	L43664	5420008892020	ARC	X			X	X	X	X
CARRIER BRIDGE LNCHR	M48A2		5420010300906		X	X		X	X	X	X
CARRIER BRIDGE LNCHR	M48A5	L43664	5420010766096	ARE	X	X		X	X	X	X
<b>GL CARRIER PERSONNEL</b>											
CARRIER PERSONNEL	M113A1	D12087	2350009686321	AEL	X			X	X	X	X
INFANTRY FIGHTING VEH	M2	J81750	2350010485920	APA	X	X		X	X	X	X
CAVALRY FIGHTING VEH	M3	C76335	2350010492695	APB	X	X		X	X	X	X
CARRIER PERSONNEL	M113A2	D12087	2350010684077	AEN	X			X	X	X	X
CARRIER PERSONNEL	M981	C12155	2350010853792	AET	X			X	X	X	X
INFANTRY FIGHTING VEH	M2A1	F40307	2350011791027	ALE	X	X		X	X	X	X
CAVALRY FIGHTING VEH	M3A1	F60462	2350011791028	ALF	X	X		X	X	X	X
INFANTRY FIGHTING VEH	M2 PIP		2350012003037	APC	X			X	X	X	X
CAVALRY FIGHTING VEH	M3 PIP		2350012003038	APD	X	X		X	X	X	X
CARRIER PERSONNEL FT	M113A3	C18234	2350012197577	AEY	X			X	X	X	X
INFANTRY FIGHTING VEH	M2A2	F40375	2350012487619	ALG	X	X		X	X	X	X
CAVALRY FIGHTING VEH	M3A2	F60530	2350012487620	ALH	X	X		X	X	X	X
CARRIER PERSONNEL	M981A3	C12155	2350013696079	AFB	X			X	X	X	X
INFANTRY FIGHTING VEH	M2A2/ODS	F40375	2350014059886	APE	X	X		X	X	X	X
CAVALRY FIGHTING VEH	M3A2/ODS	F60530	2350014059887	APF	X	X		X	X	X	X
CARRIER, PERSONNEL			2350014204716	AUK	X			X	X	X	X
INFANTRY FIGHTING VEH	M2A3	F60564	2350014360005	APG	X			X	X	X	X
CAVALRY FIGHTING VEH	M3A3	F90796	2350014360007	APH	X			X	X	X	X
CARR PERS (LINEBACK)	M6/ODS	C00384	2350014480368	AP6	X			X	X	X	X
CBT VEH MECH INF	ODS/MUA		2350014558323		X	X		X	X	X	X
<b>GM ARMORED RECONNAISSANCE AIRBORNE ASSAULT VEHICLES</b>											
ARAAV FT 152MM	M551A1	A93125	2350001405151	ALB	X	X		X	X	X	X
ARAAV FT 152MM	M551	A93125	2350008735408	ALC	X	X		X	X	X	X

Figure E-2. Identification of required forms for combat/tactical vehicles and support equipment—Continued

ECC NOUN	MODEL	LIN	NSN	EIC	REG # REQ	2408-4 WPNS REC	2408-5 MWO	2408-9 A/T/L/G	2408-9 USAGE	DD2026 USAGE	2408-9 OVHL
ARAAV NTC/OPFOR TRNG FIRE SPT VEH (BFIST)	M551 M7	A39789 F86571	2350011151579 2350014321526	ALD AP7	X X	X X		X X	X X	X X	X X
<b>GN AMPHIBIOUS CARGO CARRIERS</b>											
CARRIER CGO AHPH	M116	D10990	2350004112057	AEC	X	X		X			
<b>GQ CARRIERS, COMMAND POST</b>											
CARR CMD POST LT	M577A1		2350000566808	AED	X			X	X	X	X
CARR CMD POST LT	M577	D11538	2350008566624		X			X	X	X	X
CARR CMD POST LT	M577A2	D11538	2350010684089	AEQ	X			X	X	X	X
CARRIER COMMAND POST	XM1068	C11158	2350013545657	AE5	X			X	X	X	X
CARR CMD POST LT	M577A3	D11538	2350013696085	AE7	X			X	X	X	X
CARRIER COMMAND POST	M1068A3	C11158	2350013696086		X			X	X	X	X
<b>GR CARRIERS, CARGO TRACKED</b>											
CARRIER CARGO FT	M548	D11049	2350000784545	AEG	X			X	X	X	X
CARRIER CARGO	M993	KK0915	2350010915405	AE3	X			X	X	X	X
CARRIER CARGO FT	M548A1	D11049	2350010969356	AEU	X			X	X	X	X
CARRIER AIR DEFENSE	M975		2350011016785	3PA	X			X	X		
CARRIER AMMO (CATV)	M992	C10908	2350011104660	AEW	X			X	X	X	X
CARRIER CARGO (SUSV)	M973	C11280	2350011329099	BXA	X			X	X	X	X
CARRIER CARGO FT	M1015	C10858	2350011368744	AEX	X			X	X	X	X
CARRIER CARGO (EW)	M1015A1	C10858	2350011368745	AEZ	X			X	X	X	X
CARRIER CARGO (AMMO)	M1050	C10976	2350011631437	AE2	X			X	X	X	X
CARR CGO/FB (SUSV)	M1067	C16921	2350012816450	BXC	X			X	X	X	X
CARRIER CARGO (SUSV)	M973A1	C11280	2350012816451	BXB	X			X	X	X	X
CARRIER COMMAND POST	M1065	C11651	2350012818324	BXD	X			X	X	X	X
CARRIER AMB (SUSV)	M1066	C00255	2350012836215	BXE	X			X	X	X	X
CARRIER CARGO (AMMO)	M992A1	C10908	2350013523021	AE6	X			X	X	X	X
CARRIER CARGO (AMMO)	M992A2	C10908	2350013689500	AKA	X			X	X	X	X
CARRIER CARGO	M548A3	D11049	2350013696081	AE9	X			X	X	X	X
CARRIER CARGO	M993A1		2350014567884	AFE	X			X	X	X	X

Figure E-2. Identification of required forms for combat/tactical vehicles and support equipment—Continued

ECC NOUN	MODEL	LIN	NSN	EIC	REG # REQ	2408-4 WPNS REC	2408-5 MWO	2408-9 A/T/L/G	2408-9 USAGE	DD2026 USAGE	2408-9 OVHL
<b>GW CARRIERS, OTHER</b>											
CARR UTIL ART	M571		2350008735418	AEH	X			X	X	X	
CARRIER SMOKE GEN	M1059	C12815	2350012030188	AES	X			X	X	X	X
CARRIER SMOKE GEN	M1059A3	C12815	2350013696083	AFA	X			X	X	X	X
<b>H TACTICAL VEHICLES</b>											
<b>HA TRUCKS, 1/4 TON, AMBULANCE</b>											
TRUCK AMBULANCE 1/4T	M718A1	X38639	2310001779256	BAC	X			X	X		X
TRUCK AMBULANCE 1/4T	M718	X38639	2310007826056	BAD	X			X	X		X
TRUCK AMBULANCE 1/4T	M170	X38639	2310008358686	BAL	X			X	X		X
<b>HB TRUCKS, 1/4 TON, UTILITY</b>											
TRUCK UTILITY 1/4 TON	M825	X61244	2320001779257	BAE	X			X	X		X
TRUCK UTILITY 1/4 TON	M151A2	X60833	2320001779258	BAF	X			X	X		X
TRUCK UTILITY 1/4 TON	M151	X60833	2320005424783	BAG	X			X	X		X
TRUCK UTILITY 1/4T	M151A1C	X61244	2320007631091	BAH	X			X	X		X
TRUCK UTILITY 1/4T	M151A1	X60833	2320007631092	BAJ	X			X	X		X
TRUCK UTILITY 1/4 TON	NONE	NO-LIN	2320008358320	BAR	X			X	X		X
TRK UTIL 1/4T W/ROPS	M151A2	X60833	2320012644819	BAS	X			X	X		X
<b>HC TRUCKS, 1/2 TON, UTILITY</b>											
TRK PLTFM UTIL 1/2T	M274A1	X55627	2320000646373	BGD	X			X			
TRK PLTFM UTIL 1/2T	M274A2	X55627	2320000741167	BGE	X			X			
TRK PLTFM UTIL 1/2T	M274A3	X55627	2320007825792	BGF	X			X			
TRK PLTFM UTIL 1/2T	M274A4	X55627	2320007825793	BGG	X			X			
TRK PLTFM UTIL 1/2T	M274A5	X55627	2320009301976	BGJ	X			X			
<b>HD TRUCKS, 3/4 TON, CARGO</b>											
TRUCK CARGO 3/4 TON	M37B1W/W	X39872	2320005424632	BCG	X			X			

Figure E-2. Identification of required forms for combat/tactical vehicles and support equipment—Continued

ECC NOUN	MODEL	LIN	NSN	EIC	REG # REQ	2408-4 WPNS REC	2408-5 MWO	2408-9 A/T/L/G	2408-9 USAGE	DD2026 USAGE	2408-9 OVHL
TRUCK CARGO 3/4 TON	M37B1	X39735	2320005424636	BCA	X			X			
TRUCK CARGO 3/4T	M37	X39735	2320008358322	BCJ	X			X			
TRUCK CARGO 3/4T	M37	X39872	2320008358323	BCK	X			X			
<b>HE TRUCKS, 3/4 TON, OTHER</b>											
TRUCK AMBULANCE 3/4T	M43B1	X38776	2310005424634	FFJ	X			X			
TRUCK AMBULANCE 3/4T	M43	X38776	2310008358516	FFK	X			X			
TRUCK AMBULANCE 3/4T	M43 W/WN	NO-LIN	2310008358617	FFL	X			X	X		
TRUCK MAINT TELE 3/4T	M201	X53709	2320003923703	BCF	X			X			
TRUCK WRECKER 3/4T	M711	NO-LIN	2320009115068	BCB	X			X	X		
TRUCK DUMP 3/4T	M708	NO-LIN	2320009115071	BCC	X			X	X		
TRUCK DUMP 3/4T	M708A1	NO-LIN	2320009115078	BCD	X			X	X		
TRUCK DUMP 3/4T	M708 W/W		2320009267154	BCE	X			X	X		
TRUCK UTILITY 3/4TON	M1009	T05028	2320011232665	BEB	X		X	X	X		X
<b>HF TRUCKS, 1 1/4 TON</b>											
TRK AMBULANCE 1-1/4T	M886	X38592	2310005799078	BDB	X			X	X		X
TRK AMBULANCE 1-1/4T	M792	X38961	2310008329907	BFA	X			X	X	X	X
TRK AMBULANCE 1-1/4T	M725	X38951	2310009216369	BFE	X			X			
TRK AMBULANCE 1-1/4T	M997	T38844	2310011112274	BBA	X		X	X	X		X
TRK AMBULANCE 1-1/4T	M996	T38707	2310011112275	BBB	X		X	X	X		X
TRK AMBULANCE 1-1/4T	M1010	T38660	2310011232666	BEA	X		X	X	X		X
TRK AMBULANCE 1-1/4T	M1035		2310011467194	X	X		X	X	X		X
TRK AMBULANCE 1-1/4T	M1035A1		2310013719585	BBW	X		X	X	X		X
TRK AMBULANCE 1 1/4T	M997A1	T38844	2310013723934	BBZ	X		X	X	X		X
TRK AMBULANCE 1-1/4T	M996A1	T38707	2310013723935	BB2	X		X	X	X		X
TRK AMBULANCE 1-1/4T	M997A2	T38844	2310013808225	BB8	X		X	X	X		X
TRK AMBULANCE 1-1/4T	M1035A2		2310013808290	BB9	X		X	X	X		X
TRK AMBULANCE 1-1/4T	M966A2	T38707	2310013808313	BB7	X		X	X	X		X
TRUCK CARGO 1-1/4T	M880	X39432	2320005798942	BDC	X			X	X		X
TRUCK CARGO 1-1/4T	M881	X39444	2320005798943	BDD	X			X	X		X
TRUCK CARGO 1-1/4T	M882	X39447	2320005798957	BDE	X			X	X		X

Figure E-2. Identification of required forms for combat/tactical vehicles and support equipment—Continued

ECC NOUN	MODEL	LIN	NSN	EIC	REG # REQ	2408-4 WPNS REC	2408-5 MWO	2408-9 A/T/L/G	2408-9 USAGE	DD2026 USAGE	2408-9 OVHL
TRUCK CARGO 1-1/4T	M883	X39450	2320005798959	BDF	X			X	X		X
TRUCK CARGO 1-1/4T	M884	X39453	2320005798985	BDG	X			X	X		X
TRUCK CARGO 1-1/4T	M885	X39441	2320005798989	BDH	X			X	X		X
TRUCK CARGO 1-1/4T	M890	X39429	2320005798991	BDJ	X			X	X		X
TRUCK CARGO 1-1/4T	M892	X39435	2320005799052	BDL	X			X	X		X
TRUCK CARGO 1-1/4T	M561	X39940	2320008735407	BFB	X			X	X	X	X
TRUCK CARGO 1-1/4T	M715	X39883	2320009216365	BFD	X			X			
TRUCK CARGO 1-1/4T	M715 W/W	X39906	2320009216366	BFF	X			X			
TRUCK MAINT 1-1/4T	M726	X53775	2320009216683	BFG	X			X			
TRK MAINT TEL 1-1/4T	M888	T53498	2320010440333	BDM	X			X			X
TRUCK UTILITY 1-1/4T	M966	T05096	2320011077153	BBC	X		X	X	X		X
TRUCK UTILITY 1-1/4T	M998	T61494	2320011077155	BBD	X		X	X	X		X
TRUCK UTILITY 1-1/4T	M1038	T61562	2320011077156	BBE	X		X	X	X		X
TRUCK CARGO 1-1/4T	M1008A1	T59346	232001232671	BEC	X			X	X		X
TRUCK CARGO 1-1/4T	M1008WE	T59482	2320011236827	BED	X			X	X		X
TRUCK CARGO 1-1/4T	M1028	T59414	2320011275077	BEE	X		X	X	X		X
TRUCK UTILITY 1-1/4T	M1025	T92242	2320011289551	BBF	X		X	X	X		X
TRUCK UTILITY 1-1/4T	M1026	T92310	2320011289552	BBG	X		X	X	X		X
TRUCK UTILITY 1-1/4T	M1031		2320011335368	BBL	X			X	X		X
TRUCK UTILITY 1-1/4T	M1042		2320011467187	X	X		X	X	X		X
TRUCK UTILITY 1-1/4T	M1046	NO-LIN	2320011467188	***	X			X	X		
TRUCK UTILITY 1-1/4T	M1043		2320011467190	X	X		X	X	X		X
TRUCK UTILITY 1-1/4T	XM1055		2320011467192	X	X		X	X	X		X
TRUCK UTILITY 1-1/4T	M1037	T07543	2320011467193	BBK	X		X	X	X		X
TRUCK UTILITY 1-1/4T	XM1054		2320011481638	X	X		X	X	X		X
TRUCK UTILITY 1-1/4T	XM1056		2320011481639	X	X		X	X	X		X
TRUCK UTILITY 1-1/4T	XM1053		2320011501035	X	X		X	X	X		X
TRUCK CARGO 1-1/4T	M1028A1	T59550	2320011580820	BEF	X		X	X	X		X
TRUCK UTILITY 1-1/4T	M1069	T07611	2320012340497	BBJ	X		X	X	X		X
TRUCK CARGO 1-1/4T	NONE		2320012950822	X	X		X	X	X		X
TRK CGO DUAL REAR WHL	M1028A3	Z40435	2320013251937	X	X		X	X	X		X
TRUCK UTILITY 1-1/4T	M1097	T07679	2320013469317	BBM	X		X	X	X		X
TRUCK UTILITY 1-1/4T	M998A1	T61494	2320013719577	BBN	X		X	X	X		X

Figure E-2. Identification of required forms for combat/tactical vehicles and support equipment—Continued

ECC NOUN	MODEL	LIN	NSN	EIC	REG # REQ	2408-4 WPNS REC	2408-5 MWO	2408-9 A/T/L/G	2408-9 USAGE	DD2026 USAGE	2408-9 OVHL
TRUCK UTILITY 1-1/4T	M1038A1	T61562	2320013719578	BBP	X		X	X	X		X
TRUCK UTILITY 1-1/4T	M1026A1	T92310	2320013719579	BBQ	X		X	X	X		X
TRUCK UTILITY 1-1/4T	M1097A1	T07679	2320013719583	BBU	X		X	X	X		X
TRUCK UTILITY 1-1/4T	M1025A1	T92242	2320013719584	BBV	X		X	X	X		X
TRUCK UTILITY 1-1/4T	M966A1	T05096	2320013723932	BBX	X		X	X	X		X
TRUCK UTILITY 1-1/4T	M1043A2		2320013808213		X		X	X	X		X
TRUCK UTILITY 1-1/4T	M1025A2	T92242	2320013808233	BB3	X		X	X	X		X
TRUCK UTILITY 1-1/4T	M1097A2	T07679	2320013808604	BB6	X		X	X	X	X	X
TRUCK UTILITY 1-1/4T	M1109	T07746	2320013897558	B6A	X		X	X	X		X
TRUCK UTILITY 1-1/4T	M1113	T61630	2320014120143	B6B	X		X	X	X	X	X
TRUCK UTILITY 1-1/4T	M1114	T92446	2320014133739	B6C	X		X	X	X	X	X
TRUCK UTILITY 1-1/4T	M1123	NO-LIN	2320014559593	B6G	X		X	X			X
TRUCK UTILITY 1-1/4T	XM1151	NO-LIN	2320015187330	***	X		X	X			X
TRUCK UTILITY 1-1/4T	XM1152	NO-LIN	2320015187332	***	X		X	X			X

**HG TRUCKS, 2 1/2 TON, CARGO**

TRUCK CARGO 2-1/2T	M35A2	X40009	2320000771616	BMA	X			X	X	X	X
TRUCK CARGO 2-1/2T	M35A2WWW	X40146	2320000771617	BMB	X			X	X	X	X
TRUCK CARGO 2-1/2T	M36A2	X40283	2320000771618	BMC	X			X	X	X	X
TRUCK CARGO 2-1/2T	M36A2WWW	X40420	2320000771619	BMD	X			X	X	X	X
TRUCK CARGO 2-1/2T	M36C		2320002001368	BLG	X			X	X		X
TRUCK CARGO 2-1/2T	M36CWWW		2320002001369	BLH	X			X	X		X
TRUCK CARGO 2-1/2T	M36	X40283	2320003910569	BLL	X			X	X		X
TRUCK TANK FS	M49A1C	X57271	2320004403349	BMX	X			X	X		X
TRUCK CARGO 2-1/2T	M35A1	X40009	2320005425633	BM5	X			X	X	X	X
TRUCK CARGO 2-1/2T	M35A1WWW	X40146	2320005425634	BM6	X			X	X	X	X
TRUCK CARGO 2-1/2T	M34	NO-LIN	2320007397545	BLT	X			X	X		X
TRUCK CARGO 2-1/2T	M211 WWW	X40146	2320008344508	BLV	X			X	X		X
TRUCK CARGO 2-1/2T	M35	X40009	2320008358463	BLA	X			X	X		X
TRUCK CARGO 2-1/2T	M35WWW	X40146	2320008358464	BLB	X			X	X		X
TRUCK CARGO 2-1/2T	M34WWW	X40242	2320008358536	BL4	X			X	X		X
TRUCK CARGO 2-1/2T	M35A2C	X40077	2320009260873	BMR	X			X	X	X	X

**Figure E-2. Identification of required forms for combat/tactical vehicles and support equipment—Continued**

ECC NOUN	MODEL	LIN	NSN	EIC	REG # REQ	2408-4 WPNS REC	2408-5 MWO	2408-9 A/T/L/G	2408-9 USAGE	DD2026 USAGE	2408-9 OVHL
TRUCK CARGO 2-1/2T	M35A2CWWW	X40214	2320009260875	BMS	X			X	X	X	X
TRK CGO, LMTV 2-1/2T	M1078WOW	T60081	2320013543385	BHD	X			X	X	X	X
TRUCK CGO LMTV 21/2T	M1081WOW	T41995	2320013553064	BHF	X			X	X	X	X
TRK CGO, LMTV 2-1/2T	M1078WWW	T60149	2320013601898	BHH	X			X	X	X	X
TRK CGO, LMTV 2-1/2T	M1081WWW	T42063	2320013601899	BHJ	X			X	X	X	X
TRUCK CARGO 2-1/2T	M36A3WWW	X40420	2320013832046	EAX	X			X	X	X	X
TRUCK CARGO 2-1/2T	M35A3	X40009	2320013832047	BHK	X			X	X		X
TRUCK CARGO 2-1/2T	M36A3	X40283	2320013832048	BHM	X			X	X	X	X
TRUCK CARGO 2-1/2T	M35A3CWWW	X40214	2320013832049	BHQ	X			X	X	X	X
TRUCK CARGO 2-1/2T	M35A3C	X40077	2320013832050	BHP	X			X	X	X	X
TRUCK CARGO 2 1/2T	M35A3WWW	X40146	2320013833850	BHL	X			X	X		X
TRK CGO, LMTV 2-1/2T	M1078A1WWW	T60149	2320014473888	BHV	X			X	X		X
TRK CGO, LMTV 2-1/2T	M1078A1	T60081	2320014476343	BHR	X			X	X		X

**HH TRUCKS, 2 1/2 TON, OTHER**

TRUCK TANK FS	M49A2C	X57271	2320000771631	BME	X			X	X	X	X
TRUCK TANK FS	M49A2CWWW	X57408	2320000771632	BMF	X			X	X	X	X
TRUCK TANK WATER	M50A2	X58367	2320000771633	BMG	X			X	X	X	X
TRUCK VAN SHOP	M109A3	X62340	2320000771636	BMJ	X			X	X		X
TRUCK VAN SHOP	M109A3WWW	X62477	2320000771637	BMK	X			X	X	X	X
TRUCK TRACTOR	M275A2	X59052	2320000771640	BML	X			X	X	X	X
TRUCK TRACTOR	M275A2WWW	X59189	2320000771641	BHB	X			X	X	X	X
TRUCK VAN EXP	M292A2	X61929	2320000771642	BGL	X			X	X	X	X
TRUCK DUMP	M342A2	X43297	2320000771643	BMN	X			X	X	X	X
TRUCK DUMP	M342A2WWW	X43434	2320000771644	BMP	X			X	X	X	X
TRUCK TANK FS	M49C	X57271	2320001418235	BLD	X			X	X		X
TRUCK TANK FS	M49CWWW		2320001418237	BLE	X			X	X		X
TRUCK BOLSTER	M45	X39050	2320002773016	BLJ	X			X	X		X
TRUCK VAN SHOP	M109 WWW		2320002896473	BLK	X			X	X		X
TRUCK VAN EXP	M292	X61929	2320003256574		X			X	X		X
TRUCK, TANK	800	NONE	2320004341285	***	X			X	X		X
TRUCK TANK FS	M49A1CWWW	X57408	2320004403346	BMM	X			X	X	X	X

**Figure E-2. Identification of required forms for combat/tactical vehicles and support equipment—Continued**

ECC NOUN	MODEL	LIN	NSN	EIC	REG #	2408-4	2408-5	2408-9	2408-9	DD2026	2408-9
					REQ	WPNS REC	MWO	A/T/L/G	USAGE	USAGE	OVHL
TRUCK TANK WATER	M50A1	X58367	2320004408307	BMZ	X			X	X	X	X
TRUCK VAN SHOP	M109A2WWW	X62477	2320004408308	BM2	X			X	X	X	X
TRUCK VAN SHOP	M109A2	X62340	2320004408313	BM3	X			X	X	X	X
TRUCK VAN EXP	M292A1	X61929	2320004408318	BGM	X			X	X	X	X
TRUCK TRACTOR	M275A1	X59052	2320004462479	BM4	X			X	X	X	X
TRUCK VAN SHOP	M109A1	X62340	2320006906365	BLR	X			X	X		X
TRUCK VAN EXP	M292A5	X62203	2320006993746	BGN	X			X	X	X	X
TRUCK TANK WATER	M50	X58367	2320008358344	BLW	X			X	X		X
TRUCK TRACTOR	M48	NO-LIN	2320008356345	BLX	X			X	X		X
TRUCK TRACTOR	M48 WWW	NO-LIN	2320008356346	BLY	X			X	X		X
TRUCK VAN SHOP	M109	X62340	2320008358515	BL3	X			X	X		X
TRUCK VAN SHOP	M220	X62340	2320008356600	BL5	X			X	X		X
TRUCK PIPELINE CONSTR	M756A2	X55216	2320009043277	BMQ	X			X	X	X	X
TRUCK TANK WATER	M50A3	X58367	2320009374036	BMT	X			X	X	X	X
TRK MAINT EARTH BORER	M764	X53983	2320009375980	BMV	X			X	X	X	X
TRK TANK	M960		2320010757872	X				X		X	X
TRK VAN, LMTV 2-1/2T	M1079WWE	T93484	2320013543384	BHE	X			X	X	X	X
TRK VAN, LMTV 2-1/2T	M1079WWW	T40329	2320013601891	BHG	X			X	X	X	X
TRK VAN, LMTV 2 1/2T	M1079A1	T93484	2320014474938	BHS	X			X	X	X	X
TRUCK VAN	M109A4	NO-LIN	2320014506568	***	X			X	X		X

**HI TRUCKS, 5-TON, CARGO**

TRUCK CARGO 5-TON	M813 WWW	X40968	2320000508890	BSA	X		X	X	X	X	X
TRUCK CARGO 5-TON	M813	X40831	2320000508902	BSB	X		X	X	X	X	X
TRUCK CARGO D/S 5-TON	M813A1WWW	X40931	2320000508905	BSC	X		X	X	X	X	X
TRUCK CARGO D/S 5-TON	M813A1	X40794	2320000508913	BSD	X		X	X	X	X	X
TRUCK CARGO 5-TON	M814 WWW	X41242	2320000508987	BSJ	X		X	X	X	X	X
TRUCK CARGO 5-TON	M814	X41105	2320000508988	BSK	X		X	X	X	X	X
TRUCK CARGO 5-TON	M55A2WWW	X41242	2320000559259	BQB	X		X	X	X	X	X
TRUCK CARGO 5-TON	M54A2WWW	X40968	2320000559285	BQG	X		X	X	X	X	X
TRUCK CARGO 5-TON	M54A2	X40831	2320000559286	BQH	X		X	X	X	X	X
TRUCK CARGO 5-TON	M54A1	X40831	2320000867481	BRE	X		X	X	X	X	X

**Figure E-2. Identification of required forms for combat/tactical vehicles and support equipment—Continued**

ECC NOUN	MODEL	LIN	NSN	EIC	REG #	2408-4	2408-5	2408-9	2408-9	DD2026	2408-9
					REQ	WPNS REC	MWO	A/T/L/G	USAGE	USAGE	OVHL
TRUCK CARGO 5-TON	M55 WWW	X41242	2320003910570	BPC	X		X	X	X		X
TRUCK CARGO D/S 5-TON	M54A2C	X40794	2320007612854	BQL	X		X	X	X	X	X
TRUCK CARGO 5-TON	M54 WWW	X40968	2320008358335	BPH	X		X	X	X		X
TRUCK CARGO 5-TON	M54	X40831	2320008358348	BPM	X		X	X	X		X
TRUCK CARGO D/S 5-TON	M54A1CWWW	X40931	2320008804612	BRH	X		X	X	X	X	X
TRUCK CARGO D/S 5-TON	M54A1C	X40794	2320008804614	BRJ	X		X	X	X	X	X
TRUCK CARGO 5-TON	M656	X41310	2320009030883	BQN	X		X	X	X		X
TRUCK CARGO D/S 5-TON	M54A2CWWW	X40931	2320009260874	BQS	X		X	X	X	X	X
TRUCK CARGO 5-TON	M656 WWW	X41327	2320009998418	BQQ	X		X	X	X	X	X
TRUCK CARGO D/S 5-TON	M925	X40931	2320010478769	BRT	X		X	X	X	X	X
TRUCK CARGO 5-TON	M928	X41242	2320010478770	BRU	X		X	X	X	X	X
TRUCK CARGO 5-TON	M927	X41105	2320010478771	BRV	X		X	X	X	X	X
TRUCK CARGO 5-TON	M926	X40968	2320010478772	BRW	X		X	X	X	X	X
TRUCK CARGO 5-TON	M924	X40831	2320010478773	BRX	X		X	X	X	X	X
TRUCK CARGO D/S 5-TON	M923	X40794	2320010502084	BRY	X		X	X	X	X	X
TRUCK CARGO D/S 5-TON	M924A1	X40831	2320012052692	BSU	X		X	X	X	X	X
TRUCK CARGO 5-TON	M926A1WWW	X40968	2320012052693	BSV	X		X	X	X	X	X
TRUCK CARGO D/S 5-TON	M923A1	X40794	2320012064087	BSS	X		X	X	X	X	X
TRUCK CARGO D/S 5-TON	M925A1	X40931	2320012064088	BST	X		X	X	X	X	X
TRUCK CARGO 5-TON	M927A1	X41105	2320012064089	BSW	X		X	X	X	X	X
TRUCK CARGO 5-TON	M928A1	X41242	2320012064090	BSX	X		X	X	X	X	X
TRUCK CARGO D/S 5-TON	M923A2	X40794	2320012300307	BS7	X		X	X	X	X	X
TRUCK CARGO D/S 5-TON	M925A2	X40931	2320012300308	BS8	X		X	X	X	X	X
TRUCK CARGO 5-TON	M927A2	X41105	2320012300309	BS9	X		X	X	X	X	X
TRUCK CARGO 5-TON	M928A2	X41242	2320012300310	BTM	X		X	X	X	X	X
TRUCK CARGO MTV 5-TON	M1083WOW	T61908	2320013543386	BR2	X		X	X	X	X	X
TRUCK CARGO MTV 5-TON	M1084 W/MHE	T41203	2320013543387	BR3	X		X	X	X	X	X
TRUCK CARGO MTV 5-TON	M1085WOW	T61704	2320013544530	BR7	X		X	X	X	X	X
TRUCK CARGO MTV 5-TON	M1086MHE	T61840	2320013544531	BR8	X		X	X	X	X	X
TRUCK CARGO, LAPES 5T	M1093WOW	T41036	2320013553063	BR9	X		X	X	X	X	X
TRUCK CARGO MTV 5-TON	M1083WWW	T41135	2320013601895	BT3	X		X	X	X	X	X
TRUCK CARGO MTV 5-TON	M1093WWW	T41104	2320013601896	BT4	X		X	X	X	X	X
TRUCK CARGO MTV 5-TON	M1085WWW	T61772	2320013601897	BT5	X		X	X	X	X	X

**Figure E-2. Identification of required forms for combat/tactical vehicles and support equipment—Continued**

ECC NOUN	MODEL	LIN	NSN	EIC	REG # REQ	2408-4 WPNS REC	2408-5 MWO	2408-9 A/T/L/G	2408-9 USAGE	DD2026 USAGE	2408-9 OVHL
TRUCK CARGO MTV 5-TON	M1083A1WWW	T41135	2320014473884	BHY	X			X	X	X	X
TRUCK CARGO MTV 5-TON	M1084A1W/MH	T41203	2320014473887	BUB	X			X	X	X	X
TRUCK CARGO MTV 5-TON	M1083A1	T61908	2320014473890	BT9	X			X	X	X	X
TRUCK CARGO MTV 5-TON	M1085A1	T61704	2320014473891	BUG	X			X	X		X
TRUCK CARGO MTV 5-TON	M1086A1	T61840	2320014473895	BUH	X			X	X		X
TRUCK CARGO MTV 5-TON	M1085A1WWW	T61772	2320014473897	BUR	X			X	X		X
TRUCK DUMP, MTV 5-TON	M1090A1	T64911	2320014473899	BUE	X			X	X	X	X
TRK TRCTR, MTV 5-TON	M1088A1WWW	T61307	2320014473900	BUN	X			X	X		X
TRUCK CARGO MTV 5-TON	M1084A1W/MH		2320014950110		X			X	X		X
<b>HJ TRUCKS, 5-TON, OTHER</b>											
TRK BOLSTER 5-TON	M815	X39187	2320000508927	BSE	X		X	X	X	X	X
TRUCK DUMP 5-TON	M817 W/E	X43708	2320000508970	BSF	X		X	X	X	X	X
TRUCK TRACTOR 5-TON	M818 W/W	X59463	2320000508978	BSG	X		X	X	X	X	X
TRUCK TRACTOR 5-TON	M818	X59326	2320000508984	BSH	X		X	X	X	X	X
TRK TRACTOR WKR 5-TON	M819 W/W	X60696	2320000509004	BSL	X		X	X	X	X	X
TRUCK VAN EXP 5-TON	M820	X62237	2320000509006	BSM	X		X	X	X	X	X
TRUCK VAN EXP 5-TON	M820A1	X62237	2320000509007		X		X	X	X	X	X
TRUCK VAN EXP 5-TON	M820A2	X62271	2320000509010	BSN	X		X	X	X	X	X
TRUCK STAKE 5-TON	M821	X56586	2320000509015	BSP	X		X	X	X	X	X
TRUCK WRECKER 5-TON	M816 W/W	X63299	2320000510489	BSQ	X		X	X	X	X	X
TRUCK DUMP 5-TON	M817 W/W	X43845	2320000510589	BSR	X		X	X	X	X	X
TRUCK WRECKER 5-TON	M543A2WWW	X63299	2320000559258	BQA	X		X	X	X	X	X
TRUCK TRACTOR 5-TON	M52A2	X59326	2320000559260	BQC	X		X	X	X	X	X
TRUCK TRACTOR 5-TON	M52A2WWW	X59463	2320000559261	BQD	X		X	X	X	X	X
TRUCK DUMP 5-TON	M51A2	X43708	2320000559262	BQE	X		X	X	X	X	X
TRUCK DUMP 5-TON	M51A2WWW	X43845	2320000559263	BQF	X		X	X	X	X	X
TRK TRACTOR WKR 5-TON	M246A2WWW	X60696	2320000738251	BQJ	X		X	X	X	X	X
TRUCK TRACTOR 5-TON	M52A1	X59326	2320000867479	BRC	X		X	X	X	X	X
TRUCK TRACTOR 5-TON	M52A1WWW	X59463	2320000867480	BRD	X		X	X	X	X	X
BRIDGE TRANSPORTER-5T	NONE	X56586	2320002001682	BPA	X		X	X	X		X
TRUCK WRECKER 5-TON	M543 W/W	X63299	2320004450866	BPD	X		X	X	X		X

Figure E-2. Identification of required forms for combat/tactical vehicles and support equipment—Continued

ECC NOUN	MODEL	LIN	NSN	EIC	REG # REQ	2408-4 WPNS REC	2408-5 MWO	2408-9 A/T/L/G	2408-9 USAGE	DD2026 USAGE	2408-9 OVHL
TRUCK WRECKER 5-TON	M62 W/W	X63299	2320008358325	BPE	X		X	X	X		X
TRUCK TRACTOR 5-TON	M52	X59326	2320008358326	BPF	X		X	X	X		X
TRUCK TRACTOR 5-TON	M52 W/W	X59463	2320008358329	BPG	X		X	X	X		X
TRUCK DUMP 5-TON	M51	X43708	2320008358336	BPJ	X		X	X	X		X
TRUCK DUMP 5-TON	M51 W/W	X43845	2320008358337	BPK	X		X	X	X		X
TRUCK WRECKER 5-TON	NONE	NO-LIN	2320008358476	***	X		X	X	X		X
TRK TRACTOR WKR 5-TON	M246 W/W	X60696	2320008358639	BPP	X		X	X	X		X
TRUCK VAN EXP 5-TON	M291A1	X62237	2320008804642	BRP	X		X	X	X	X	X
TRUCK VAN EXP 5-TON	M291A1D	X62271	2320008804647	BRQ	X		X	X	X	X	X
TRK STK BRIDGE	M328A1	NO-LIN	2320008804652	BRR	X		X	X	X		X
TRUCK STAKE 5-TON	NONE	NO-LIN	2320008892171	***	X		X	X	X		X
TRUCK VAN EXP 5-TON	M291A2C	NO-LIN	2320009070707	***	X		X	X	X		X
TRUCK WRECKER 5-TON	NONE	NO-LIN	2320009260984	***	X		X	X	X		X
TRUCK TRACTOR 5-TON	M757 W/W	X59505	2320009371846	BQP	X		X	X	X		X
TRUCK TRACTOR 5-TON	M878	T60353	2320010448376	BTA	X		X	X	X		X
TRUCK VAN EXP 5-TON	M934	X62237	2320010478750	BTB	X		X	X	X	X	X
TRUCK VAN EXP 5-TON	M935	X62271	2320010478751	BTC	X		X	X	X	X	X
TRUCK TRACTOR 5-TON	M932 W/W	X59463	2320010478752	BDT	X		X	X	X	X	X
TRUCK TRACTOR 5-TON	M931	X59326	2320010478753	BTE	X		X	X	X	X	X
TRUCK WRECKER 5-TON	M936 W/W	X63299	2320010478754	BTG	X		X	X	X	X	X
TRUCK DUMP 5-TON	M930	X43845	2320010478755	BTJ	X		X	X	X	X	X
TRUCK DUMP 5-TON	M929	X43708	2320010478756	BTH	X		X	X	X	X	X
TRUCK TRACTOR 5-TON	M878A1	T60353	2320011212102	BTL	X		X	X	X	X	X
TRUCK VAN EXP 5-TON	M934A1	X62237	2320012052682	BS4	X		X	X	X	X	X
TRUCK VAN EXP 5-TON	M935A1	X62271	2320012052683	BS5	X		X	X	X	X	X
TRUCK TRACTOR 5-TON	M932A1WWW	X59463	2320012052684	BS3	X		X	X	X	X	X
TRUCK TRACTOR 5-TON	M931A1	X59326	2320012064077	BS2	X		X	X	X	X	X
TRUCK WRECKER 5-TON	M936A1	X63299	2320012064078	BS6	X		X	X	X	X	X
TRUCK DUMP 5-TON	M929A1WWW	X43708	2320012064079	BSY	X		X	X	X	X	X
TRUCK DUMP 5-TON	M930A1WWW	X43845	2320012064080	BSZ	X		X	X	X	X	X
TRUCK VAN EXP 5-TON	M934A2	X62237	2320012300300	BTR	X		X	X	X	X	X
TRUCK VAN EXP 5-TON	M935A2	X62271	2320012300301	BTS	X		X	X	X	X	X
TRUCK TRACTOR 5-TON	M931A2	X59326	2320012300302	BTP	X		X	X	X	X	X

Figure E-2. Identification of required forms for combat/tactical vehicles and support equipment—Continued



ECC NOUN	MODEL	LIN	NSN	EIC	REG # REQ	2408-4 WPNS REC	2408-5 MWO	2408-9 A/T/L/G	2408-9 USAGE	DD2026 USAGE	2408-9 OVHL
TRUCK TRACTOR 5-TON	M932A2WW	X59463	2320012300303	BTQ	X		X	X	X	X	X
TRUCK WRECKER 5-TON	M936A2WW	X63299	2320012300304	BTT	X		X	X	X	X	X
TRUCK DUMP 5-TON	M929A2	X43708	2320012300305	BTN	X		X	X	X	X	X
TRUCK DUMP 5-TON	M930A2	X43845	2320012300306	BTO	X		X	X	X	X	X
TANK FUEL/WATER	XM1091	NO-LIN	2320013544527	BR6	X		X	X			
TRUCK WRKR, MTV 5-TON	M1089WW	T94709	2320013544528	BR4	X		X	X	X	X	X
TRUCK DUMP, MTV 5-TON	M1090WE	T64911	2320013544529	BR5	X		X	X	X	X	X
TRUCK DUMP, MTV 5-TON	M1094WOW	T65526	2320013553062	BTX	X		X	X	X	X	X
TRK TRCTR, MTV 5-TON	M1088	T61239	2320013554332	BTJ	X		X	X	X	X	X
TRK TRCTR, MTV 5-TON	M1088WW	T61307	2320013601892	BTY	X		X	X	X	X	X
TRUCK DUMP, MTV 5-TON	M1090WWW	T64979	2320013601893	BTZ	X		X	X	X	X	X
TRUCK DUMP, MTV 5-TON	M1094WWW	T65594	2320013601894	BT2	X		X	X	X	X	X
TRUCK WRKR, MTV 5-TON	M1089A1		2320014473892	BUD	X		X	X	X	X	X
TRK TRCTR, MTV 5-TON	M1088A1	T61239	2320014473893	BUC	X		X	X	X	X	X
TRUCK DUMP MTV 5-TON	NONE	T64979	2320014476344	BUP	X		X	X			
TRUCK TRACTOR 5-TON	M878A2	NO-LIN	2320014524525	***	X		X	X			
TRUCK, VAN, MTV 5-TON	M1087A1 WOW	NO-LIN	2320014590362	BUK	X		X	X			
<b>HK TRUCKS, 8-TON</b>											
TRUCK CARGO 8-TON	M520	X41615	2320001911310	B3A	X		X	X	X		
TRUCK CARGO 8-TON	M520 WWW	X41653	2320008735422	B3D	X		X	X	X		X
TRUCK CARGO 8-TON	M877 WWW	X41635	2320010104956	B3F	X		X	X	X		X
TRUCK CARGO 8-TON	M877	X41633	2320010104957	B3G	X		X	X	X		X
<b>HL TRUCKS, 10-TON</b>											
TRUCK CARGO 10-TON	M125	X41790	2320002197340		X		X	X	X	X	X
TRUCK TRACTOR 10-TON	M123A1C	X59874	2320002266081	BZC	X		X	X	X	X	X
TRUCK TRACTOR 10-TON	M123C WW	X59874	2320002949552	BZA	X		X	X	X	X	X
TRUCK TANK FS 10-TON	M559	X58078	2320004457250	B3B	X		X	X	X	X	X
TRUCK CARGO 10T	M125A1 WWW	X41790	2320007400493	BZB	X		X	X	X	X	X
TRUCK TANK FS 10-TON	M559 WWW	X58093	2320008735420	B3C	X		X	X	X	X	X
TRUCK WRECKER 10-TON	M553	X63436	2320008735426	B3E	X		X	X	X	X	X

Figure E-2. Identification of required forms for combat/tactical vehicles and support equipment—Continued

ECC NOUN	MODEL	LIN	NSN	EIC	REG # REQ	2408-4 WPNS REC	2408-5 MWO	2408-9 A/T/L/G	2408-9 USAGE	DD2026 USAGE	2408-9 OVHL
TRUCK TRACTOR 10-TON	M123E2	X59874	2320008796177	BZD	X		X	X	X	X	X
TRUCK CARGO 10-TON	NONE	NO-LIN	2320008925377	***	X		X	X	X	X	X
TRUCK TRACTOR 10-TON	M983 WWW	T88677	2320010970247	B2A	X		X	X	X		
TRUCK WRECKER 10-TON	M984 WWW	T63093	2320010970248	B2B	X		X	X	X	X	X
TRUCK TANK FS 10-TON	M978 WWW	T58161	2320010970249	B2C	X		X	X	X	X	X
TRUCK CARGO 10-TON	M977 WWW	T39518	2320010970260	B2D	X		X	X	X	X	X
TRUCK CARGO 10-TON	M985 WWW	T39654	2320010970261	B2E	X		X	X	X	X	X
TRUCK TRACTOR 10-TON	M983 W/CRANE	T59117	2320010996421	B2F	X		X	X	X	X	X
TRUCK CARGO 10-TON	M977	T59278	2320010996426	B2G	X		X	X	X	X	X
TRUCK TANK FS 10-TON	M978	T87243	2320011007672	B2H	X		X	X	X	X	X
TRUCK CARGO 10-TON	M985	T39586	2320011007673	B2J	X		X	X	X	X	X
TRUCK CARGO 10-TON	M985E1	T41721	2320011947032	B2K	X		X	X	X	X	X
TRUCK WRECKER 10-TON	M984A1	T63093	2320011957641	B2L	X		X	X	X	X	X
TRK CGO (CBT) 10-T	M1977WOW	T91308	2320014421940	DVZ	X		X	X	X	X	X
TRK CGO (CBT) 10-T	M1977WWW	T91308	2320014438023	DV4	X		X	X	X	X	X
TRUCK CARGO	M1120 WOW	T96496	2320014711326	B5E	X		X	X	X	X	X
TRUCK, PLS	M1120 WWW	T96496	2320014722731	B5D	X		X	X	X	X	X
TRUCK CARGO 10-TON	M985A2 WOW	T39586	2320014928201	B3K	X		X	X	X	X	X
TRUCK CARGO 10-TON	M985A2 W/W	T39654	2320014928214	B2Z	X		X	X	X	X	X
TRUCK TANK FS 10-TON	M978A2 WOW	T87243	2320014928215	BT2	X		X	X	X	X	X
TRUCK TANK	M978A2 WWW	T58161	2320014928216	B2R	X		X	X	X	X	X
TRK CGO (CBT) 10-T	M1977A2 WOW	NO-LIN	2320014928218	***	X		X	X	X	X	X
TRK CGO	M1977A2	NO-LIN	2320014928219	***	X		X	X	X	X	X
TRUCK, PLS	M1120A2	T96496	2320014928221	B3P	X		X	X	X	X	X
TRUCK WRECKER 10-TON	M984A2	T63093	2320014928224	B2X	X		X	X	X	X	X
TRUCK TANK 10-T WOW	M978A2R1	T87243	2320014928225	B2U	X		X	X	X	X	X
TRUCK TANK 10-T W/W	M978A2R1 W/W	T58161	2320014928226	B2S	X		X	X	X	X	X
TRUCK, PLS	M1120A2R1	T96496	2320014928230	B3Q	X		X	X	X	X	X
TRUCK TRACTOR 10-TON	M983A2R1	NO-LIN	2320014928231	***	X		X	X	X	X	X
TRUCK WRECKER 10-TON	M984A2R1	NO-LIN	2320014928233	***	X		X	X	X	X	X
TRUCK CARGO 10-TON	M977A2 W/W	T39518	2320014933774	B2M	X		X	X	X	X	X
TRUCK CARGO 10-TON	M977A2 WOW	T59278	2320014933779	B2P	X		X	X	X	X	X
TRUCK CARGO 10-TON	M977A2R1 W/W	T39518	2320014933782	B2N	X		X	X	X	X	X

Figure E-2. Identification of required forms for combat/tactical vehicles and support equipment—Continued

ECC NOUN	MODEL	LIN	NSN	EIC	REG # REQ	2408-4 WPNS REC	2408-5 MWO	2408-9 A/T/L/G	2408-9 USAGE	DD2026 USAGE	2408-9 OVHL
TRUCK CARGO 10-TON	M977A2R1	T59278	2320014933785	B2Q	X		X	X	X	X	X
TRUCK CARGO 10-TON	M985A2R1 VWW	T39654	2320014933787	B3J	X		X	X	X	X	X
TRUCK CARGO 10-TON	M985A2R1WO/	T39586	2320014933789	B3L	X		X	X	X	X	X
TRUCK CARGO 10-TON	M985E1A2	T41721	2320014933790	B3M	X		X	X	X	X	X
TRUCK CARGO 10-TON	M985E1A2R1	T41721	2320014933792	B3N	X		X	X	X	X	X
TRUCK BODY BUILDER	M977A2R1 EPP	NO-LIN	2320014977036	***	X		X	X	X	X	X
TRUCK WRECKER 10-TON	M1001	T88745	2320121915422	BZE	X		X	X	X	X	X
TRUCK WRECKER 10-TON	M1002	T94641	2320121915423	BZF	X		X	X	X	X	X
TRUCK TRACTOR 10-TON	M1013	NO-LIN	2320121915424	***	X		X	X	X	X	X
TRUCK WRECKER 10-TON	M1014	NO-LIN	2320121915425	***	X		X	X	X		X
<b>HM TRUCKS, 12 TO 25 TONS</b>											
TRUCK MAINT TELE	M876	T53858	2320000000114	BHA	X		X	X	X	X	X
TRUCK TRACTOR HET	M746	X60967	2320000897264	B5A	X		X	X	X	X	X
TRUCK TRACTOR HET	M911	T61035	2320010253733	B5B	X		X	X	X	X	X
TRK TRACTOR LINE HAUL	M915	T61103	2320010284395	B4A	X		X	X	X	X	X
TRUCK TRACTOR LET	M916	T91656	2320010284396	B4C	X		X	X	X	X	X
TRUCK TRACTOR MET	M920	T61171	2320010284397	B4D	X		X	X	X	X	X
TRK TRACTOR LINE HAUL	M915A1	T61103	2320011252640	B4B	X		X	X	X	X	X
TRUCK TRACTOR	M916A1	T91656	2320012725028	B4F	X		X	X	X	X	X
TRUCK TRACTOR	M915A2	T61103	2320012725029	B4E	X		X	X	X	X	X
TRK CGO HVY PLS W/MHE	M1074	T41067	2320013042277	B4G	X		X	X	X	X	X
TRK CGO HVY PLS	M1075	T40999	2320013042278	B4H	X		X	X	X	X	X
TRUCK TRACTOR HET SYS	M1070	T59048	2320013189902	B5C	X		X	X	X	X	X
TRUCK TRACTOR	NONE		2320014076487	B4K	X		X	X	X		X
TRUCK TRACTOR	M916A2	T91656	2320014311163	B4J	X		X	X	X	X	X
TRUCK TRACTOR	M915A3	T61103	2320014324847	B4L	X		X	X	X	X	X
TRUCK TRACTOR	M915A4	T61103	2320014581207	B4M	X		X	X	X	X	X
TRUCK TRACTOR LET	M916A3	NO-LIN	2320014886962	***	X		X	X	X	X	X
<b>HQ ARMORED CARS</b>											
CAR ARMD LT 4X4 W/E	M706	D06124	2320001682620	ALJ	X			X			

Figure E-2. Identification of required forms for combat/tactical vehicles and support equipment—Continued

ECC NOUN	MODEL	LIN	NSN	EIC	REG # REQ	2408-4 WPNS REC	2408-5 MWO	2408-9 A/T/L/G	2408-9 USAGE	DD2026 USAGE	2408-9 OVHL
<b>HS SEMI-TRAILERS</b>											
STRLR VAN	M146F	S73668	2330000156620	CHL	X			X			
STRLR STAKE (12T)	M127A1	S72024	2330000487743	CVA	X			X			
STRLR (LOW BED)	XM674	NO-LIN	2330000668872	***	X			X			
STRLR (LB-HET-60T)	M747	S70661	2330000897265	CFA	X			X			
STRLR (LB-22-12T)	M871	S70027	2330001226779	CVB	X		X	X			
STRLR (LOW BED-40T)	M870	S70594	2330001331731	CFB	X			X			
STLR (LOW BED)	V398/MSA	S70877	2330001573135	L5Z	X			X			
STRLR (LB-HET-55T)	M524E2	S70654	2330002265770	CXS	X			X			
STRLR TANK (FUEL-12T)	M131A5	S72846	2330002266079	CVL	X		X	X			
STRLR TANK (FUEL-12T)	M131A5C	S72983	2330002266080	CVM	X		X	X			
STRLR (REFRIG-7-1/2T)	QST-120	S71613	2330002558065	VRQ	X			X			
STRLR (REFRIG-7-1/2T)	M349A1	S71613	2330002896798	VRS	X			X			
STRLR (LB WRKR-12T)	M270A1	S70243	2330002897515	CVG	X			X			
STRLR (LOW BED-25T)	M172A1	S70517	2330003176448	CFD	X		X	X			
STRLR (LB WRKR-12T)	M270	S70243	2330003951877	CVJ	X		X	X			
STRLR VAN (SHP FLDNG)	NONE	KK0400	2330004729999	CHY	X		X	X			
STLR TANK (TRANS-50T)	M15A2	S73394	2330005082533	CXR	X			X			
STRLR TANK (FUEL-12T)	M131A3C	S72846	2330005333380	CVN	X			X			
STLR (LB WRECKER-12T)	M269A1	S70106	2330005422980	CVK	X			X			
STRLR VAN (SHP FLDNG)	M447		2330005425709	CHZ	X			X			
STRLR (REFRIG-7-1/2T)	M349A1	S71613	2330005548676	VRU	X			X			
STRLR VAN (SHOP-6T)	M146	S75038	2330005699372	CHJ	X			X			
STRLR STAKE (6T)	M118A1	S71887	2330005726221	CHB	X			X			
STRLR TANK (FUEL-12T)	M131A2	S72846	2330005747964	CVP	X			X			
STRLR VAN (STOR-6T)	M749	S74832	2330005872454	CRA	X			X			
STRLR MAINT	NONE		2330006243364	CHD	X			X			
STLR MAINT MACH (12T)	NONE	S71339	2330006500203	CV7	X			X			
STRLR VAN (ELECT)	M373A2C		2330006727496	X	X			X			
STRLR VAN (ELEC-3-6T)	M348A2	S74216	2330006783838	CHF	X			X			
STRLR VAN CARGO (6T)	M119A1	S73531	2330006795582	CHG	X			X			

Figure E-2. Identification of required forms for combat/tactical vehicles and support equipment—Continued

ECC NOUN	MODEL	LIN	NSN	EIC	REG #	2408-4	2408-5	2408-9	2408-9	DD2026	2408-9
					REQ	WPNS REC	MWO	A/T/L/G	USAGE	USAGE	OVHL
STRLR VAN (ELECT)	M348A2C		2330006907724		X			X			
STRLR VAN (ELECT)	M348A2D		2330006907725		X			X			
STRLR VAN (ELECT)	M348A2F		2330006907726		X			X			
STRLR VAN (ELEC-3-6T)	M373A2	S74353	2330007058932	CHH	X			X			
STRLR (LOW BED)	15T	S70517	2330007359326	CV9	X			X			
STRLR VAN (ELECT)	M348A2K		2330007402322		X			X			
STRLR VAN (ELECT)	M348A2N		2330007402329		X			X			
STRLR STAKE (12T)	M127A1C	S72024	2330007529750	CVD	X			X			
STRLR VAN (CARGO-12T)	M128A1C	S74079	2330007529751	CV6	X			X			
STRLR VAN	M129A1C	S75175	2330007529752	CWA	X			X			
STRLR VAN EXP (6T)	M313	S74490	2330007725273	CHW	X			X			
STRLR VAN	NONE		2330007817755		X			X			
STRLR VAN (SUP-12T)	M129A2C	S75175	2330007866289	CV2	X			X			
STRLR VAN (CARGO-12T)	M128A2C	S74079	2330007866296	CV3	X			X			
STRLR STAKE (12T)	M127A2C	S72024	2330007866299	CVE	X			X			
STRLR VAN REFG-7 1/2T	M349A3		2330007867263		X			X			
STRLR VAN (ELECT)	M348A2G		2330007977405		X			X			
STRLR STAKE (12T)	M127	S72024	2330007979207	CVF	X			X			
STRLR VAN (ELECT)	NONE		2330008298619		X			X			
STRLR VAN (CARGO-6T)	M119	S73531	2330008358122	CHN	X			X			
STRLR (REFRIG-7-1/2T)	M349A3	S71613	2330008925057	VRV	X			X			
STRLR VAN REFG-7 1/2T	M349A4		2330009260900		X			X			
STRLR VAN (STOR -6T)	M750	S74832	2330009267035	CHX	X			X			
STRLR VAN	M348A2H		2330009731262		X			X			
STRLR (REFRIG-7-1/2T)	M349A1	S71613	2330009732230	VRY	X			X			
STRLR TANK (FUEL-12T)	M131A4C	S72983	2330009949458	CVR	X		X	X			
STRLR TANK (FUEL-12T)	M131A4	S72846	2330009949459	CVS	X		X	X			
STRLR (REFRIG 7-1/2T)	4A943-60	S71613	2330009993591	VRZ	X			X			
STRLR VAN	XM912		2330010137764		X			X			
STRLR (FLAT BED-34T)	M872	S70159	2330010398095	CFE	X		X	X			
STRLR TANK (FUEL)	M967	S10059	2330010505632	CVT	X		X	X			
STRLR TANK (FUEL)	M969	S73372	2330010505634	CVU	X		X	X			
STRLR TANK (FUEL)	M970	S10127	2330010505635	CVV	X		X	X			

Figure E-2. Identification of required forms for combat/tactical vehicles and support equipment—Continued

ECC NOUN	MODEL	LIN	NSN	EIC	REG #	2408-4	2408-5	2408-9	2408-9	DD2026	2408-9
					REQ	WPNS REC	MWO	A/T/L/G	USAGE	USAGE	OVHL
STRLR VAN	XM971		2330010508810	C4Y	X			X			
STRLR (LOW BED)	M860		2330010549771		X			X			
STRLR MAINT	ANARM185	M03035	2330010550005	JFA	X			X			
STRLR VAN	NONE	NO-LIN	2330010938322	C44	X			X			
STRLR (FLAT BED-34T)	M872A1	S70159	2330011098006	CFF	X			X			
STRLR TANK(FLAM CHEM)	NONE	S72256	2330011126564	C4K	X			X			
STRLR	NONE	N-LIN	2330011138658	***	X			X			
STRLR (LOW BED)	M860A1		2330011173280		X			X			
STRLR (FLAT BED)	NONE	S69977	2330011173306		X			X			
STRLR (FLAT BED-34T)	M872A2	S70159	2330011195837	CFG	X			X			
STRLR VAN	XM971E1		2330011367663	C4Z	X			X			
STRLR (FLAT BED-34T)	M872A3	S70159	2330011421385	CFH	X			X			
STRLR VAN	XM991E1		2330011450363	C5H	X			X			
STRLR VAN	XM995E1		2330011450364	C48	X			X			
STRLR TANK (FUEL)	M967A1	S10059	2330011550046	CVW	X			X			
STRLR TANK (FUEL)	M970A1	S10127	2330011550047	CVX	X		X	X			
STRLR TANK (FUEL)	M969A1	S73372	2330011550048	CVY	X		X	X			
STRLR TNK SLUDGE DISP	NONE	S73325	2330011589213	C4T	X			X			
STRLR VAN	XM971E2		2330011635025	C42	X			X			
STLR VAN (SUP-12T)	M129A3	S75175	2330011757379	CWB	X			X			
STRLR (LOW BED)	M870A1	S70594	2330012249245	CFC	X			X			
TRLR (LOW BED-70T)	NONE	S70729	2330012253326	CXM	X			X			
STRLR (FB-22 1/2T)	M871A1	S70027	2330012260701	CWY	X		X	X			
STRLR TANK PETROLEUM	M1062	S73119	2330012757475	C4V	X		X	X			
STRLR (FB-22 1/2T)	M871A2	S70027	2330012943367	CVZ	X			X			
TRLR (LB HET 70T)	M1000	S70859	2330013038832	CXU	X			X			
STRLR TANK (WATER)	XM1098	S09989	2330013302779	C5G	X		X	X			
TRLR VAN (12T)	M129A4	S75175	2330013725642	CW3	X			X			
STRLR TANK (FUEL)	M969A2	S73372	2330013779337	CW2	X		X	X			
SEMITRAILER, LOW BED	M870A3		2330014582061	CFJ	X			X			
STRLR (LB-22 1/2T)	M871A3	S70027	2330014586865	***	X			X			
TRLR TANK	M969A3	S73372	2330014950043		X			X			
STRLR (FLAT BED-34T)	M872A4	S70159	2330014970706	***	X			X			

Figure E-2. Identification of required forms for combat/tactical vehicles and support equipment—Continued

ECC NOUN	MODEL	LIN	NSN	EIC	REG # REQ	2408-4 WPNS REC	2408-5 MWO	2408-9 A/T/L/G	2408-9 USAGE	DD2026 USAGE	2408-9 OVHL
STRLR TRNR ARMD VEH	M1	T05375	6920011793134	3BN	X			X			
STRLR TRNR ARMD VEH	M2/M3	T05443	6920011793135	4WS	X			X			
<b>HT TRAILERS</b>											
TRLR ACFT MAINT ARMBL	NONE	W93995	1730004357818	UAY				X			
TRLR ACFT MAINT ARMBL	NONE	W93995	1730010861653	UAC				X			
TRLR BOLSTER GP (4T)	M796	W94536	2330000893866	CNC	X			X			
TRLR (FLAT BED-4T)	M795	NO-LIN	2330000894321	***	X			X			
TRLR TNK (WTR-1-1/2T)	M107A2	W98825	2330001418049	CEB	X			X			
TRLR CARGO (1-1/2T)	M105A2	W95811	2330001418050	CEC	X			X			
TRLR (BOLSTER-3-1/2T)	M271A1	W94578	2330001418302	CND	X			X			
TRLR (FLAT BED-10T)	M345	W96907	2330002001737	CAJ	X			X			
TRLR (AMMO-1-1/2T)	M332	W94030	2330002001785	CEK	X			X			
TRLR MAINT TELE(1/4T)	M367	W97729	2330002154211	CKK	X			X			
TRLR CARGO (1 1/2T)	M105E2	NO-LIN	2330002197344	***	X			X			
TRLR CARGO (1-1/2T)	M105	W95811	2330002779337	CED	X			X			
TRLR LOW BED	D60-DS7	W97592	2330003684315	CZF	X			X			
TRLR (FLAT BED-10T)	NONE	W96907	2330003770389	CAB	X			X			
TRLR(CBL REEL-3-1/2T)	M310	W95263	2330003951878	CNE	X			X			
TRLR (LOW BED-8T)	T62057	W97455	2330004070662	CKL	X			X			
TRLR (BOLSTER-3-1/2T)	M271	W94578	2330004077904	CNG	X			X			
TRLR TNK (WTR-1-1/2T)	M149	W98825	2330005422039	CEE	X			X			
TRLR (CBL REEL-4T)	NONE	W95268	2330005425623	CNP	X			X			
TRLR (LOW BED)	NONE		2330006295913		X			X			
TRLR BAS UTIL(2-1/2T)	NONE	W94441	2330006978102	CMC	X			X			
TRLR CARGO (1/4T)	M416	W95400	2330007065495	CCB	X			X			
TRLR CARGO (1/4T)	M100	W95400	2330007328227	CCA	X			X			
TRLR CARGO (3/4T)	M101	W95537	2330007389509	CDA	X			X			
TRLR TANK (WATER)	M106		2330007540508		X			X			
TRLR (LOW BED-7T)	M529		2330007800801		X			X			
TRLR (LOW BED-8T)	KS-8FW	W97455	2330007826053	CKM	X			X			
TRLR MAINT TELE(1/4T)	M716	W97729	2330007826062	CCC	X			X			

Figure E-2. Identification of required forms for combat/tactical vehicles and support equipment—Continued

ECC NOUN	MODEL	LIN	NSN	EIC	REG # REQ	2408-4 WPNS REC	2408-5 MWO	2408-9 A/T/L/G	2408-9 USAGE	DD2026 USAGE	2408-9 OVHL
TRLR TNK WTR (1-1/2T)	M149A1	W98825	2330008328801	CEF	X			X			
TRLR BOLSTER (3-1/2T)	M271	W94578	2330008342167	CNH	X			X			
TRLR CARGO	M7		2330008358166		X			X			
TRLR TNK (WTR-1-1/2T)	M107	W98825	2330008358540	CEG	X			X			
TRLR CARGO (1-1/2T)	M104A1		2330008358630		X			X			
TRLR CARGO (1-1/2T)	M105A1	W95811	2330008358631	CEH	X			X			
TRLR TANK (WATER)	M106A1		2330008358632		X			X			
TRLR TNK (WTR-1-1/2T)	M107A1	W98825	2330008358633	CEJ	X			X			
TRLR VAN	XM581 2W		2330008566625		X			X			
TRLR CARGO (3/4T)	M101A1	W95537	2330008986779	CDC	X			X			
TRLR (BOLSTER-9T)	GPT 28	W94852	2330009267157	CPT	X			X			
TRLR (FLAT BED-6T)	XM789	W96701	2330009354450	CPD	X			X			
TRLR MAINT	NONE		2330009835354		X			X			
TRLR CARGO (1/4T)	M416A1	W95400	2330010462855	CCD	X			X			
TRLR (FLAT BED-15T)	HYS HP	T96975	2330010608141	C3C	X			X			
TRLR CARGO (3/4T)	M101A2	W95537	2330011024697	CDB	X			X			
TRLR TNK WTR (1-1/2T)	M149A2	W98825	2330011087367	CEA	X			X			
RLR AMMO (FB-11T)	M989	T45465	2330011094258	CAA	X			X			
TRLR (BOLSTER GP-4T)	M796A1	W94536	2330011375116	CNA	X			X			
TRLR VAN (AUDIO TEST)	NONE	T99088	2330011769358	C83	X			X			
TRLR (FLAT BED)	NONE	NO-LIN	2330012073532	CRD	X			X			
TRLR (FLAT BED 5T)	M1061A1	T96883	2330012073533	C9B	X			X			
TRLR CARGO (FB-11T)	M989A1	T45465	2330012757474	CAG	X			X			
TRLR PLS (8X20)	M1076	T93761	2330013035197	C9C	X			X			
TRLR CARGO (3/4T)	M101A3		2330013725641	CDD	X			X			
TRLR CGO (1-1/4T)	M1102	T95924	2330013875426	CBB	X			X			
TRLR CARGO (HMT)	M1101	T95992	2330013875443	CBC	X			X			
TRLR WTR 8 WHL	M1112	W98825	2330013899073	C6K	X			X			
TRLR FLAT BED	M1082	T96564	2330014491775	CMN	X			X			
TRLR FLAT-BED	M1095	T95555	2330014491776	CPK	X			X			
TRLR CARGO	NONE	W95811	2330014521218	CEP	X			X			
TRLR TNK WATER	NONE	NO-LIN	3820014376662	***	X			X			
TRLR PLATFORM WHSE	MIL17479	W98270	3920008561342					X			

Figure E-2. Identification of required forms for combat/tactical vehicles and support equipment—Continued

ECC NOUN	MODEL	LIN	NSN	EIC	REG # REQ	2408-4 WPNS REC	2408-5 MWO	2408-9 A/T/L/G	2408-9 USAGE	DD2026 USAGE	2408-9 OVHL
<b>HU TRUCK CHASSIS</b>											
TRK CHASSIS (2 1/2T)	M45A2	KC0250	2320000771622		X			X			
TRK CHASSIS (2 1/2T)	M45A2WW	KC0260	2320000771623		X			X			
TRK CHASSIS (2 1/2T)	M46A2	KC0270	2320000771628		X			X			
TRK CHASSIS (2 1/2T)	M46A2C	KC0290	2320000771630		X			X			
TRUCK CHASSIS	M724	NO-LIN	2320009216368	***	X			X			
TRUCK CHASSIS	M945 W/W	KC0100	2320010504894		X			X			
TRUCK CHASSIS	M942A1WWW		2320012052665					X			
TRUCK CHASSIS	M942A1		2320012052666					X			
TRUCK CHASSIS	M944A1		2320012052667					X			
TRUCK CHASSIS	M942A2		2320012300287	BTU				X			
TRUCK CHASSIS	M944A2		2320012300288	BTW	X			X			
TRUCK CHASSIS	M942A2		2320012300289	BTV				X			
TRUCK CHASSIS	M945A2		2320012303261	BTX				X			
TRUCK CHASSIS	M1080	Z40617	2320013539098	BHC	X			X			
TRUCK CHASSIS	M1092	Z93881	2320013543382	BRZ	X			X			
CHASSIS	M988		2350011819089		X			X	X		
<b>HW TRAILER CHASSIS (ALL)</b>											
CHASSIS STLR MILVAN	NONE	E02395	2330001682259	CV4	X			X			
<b>HY DOLLIES</b>											
DOLLY SET (5-1/4T)	M832	G34815	2330002214939	CPB	X			X			
DOLLY SET (5-1/4T)	M689	G34815	2330002266076	CPC	X			X			
DOLLY SET	XM829		2330004840861		X			X			
DOLLY TRLR CONV (8T)	M198A1	G35226	2330005637248	CQB	X			X			
DOLLY TRLR CONV (6T)	M197A1	G35089	2330005690782	CHA	X			X			
DOLLY TRLR CONV(18T)	M354	G35363	2330007095848	CV5	X			X			
DOLLY SET TRLR CONV	M197	G35089	2330008358615	CYD	X			X			
DOLLY SET LIFT TRANS	M707A1	G34805	2330008789365	CYA	X			X			
DOLLY SET LIFT TRANS	M707	G34805	2330009115072	CYB	X			X			

Figure E-2. Identification of required forms for combat/tactical vehicles and support equipment—Continued

ECC NOUN	MODEL	LIN	NSN	EIC	REG # REQ	2408-4 WPNS REC	2408-5 MWO	2408-9 A/T/L/G	2408-9 USAGE	DD2026 USAGE	2408-9 OVHL
DOLLY SET (3T)	M720	G34805	2330009124251	CME	X			X			
DOLLY SET (MUST)	M840	G34741	2330009371175	CMF	X			X			
DOLLY TRLR CONV	NONE		2330010093360		X			X			
DOLLY SET (7-1/2T)	M1022	D34883	2330011677262	CYC				X			
DOLLY SET (7-1/2T)	M1022A1	D34883	2330013789997	CML	X			X			
DOLLY TRLR REAR	NONE	NO-LIN	2330014375702	***	X			X			
<b>J COMMUNICATIONS AND ELECTRONIC EQUIPMENT</b>											
<b>JS OPERATION CENTRAL COMMUNICATIONS</b>											
LANDING CONTROL CENT	ANTSQ72A	L36405	5895004043273	JP2	X			X			
DATA ANAL CENTRAL	OL88MYK8	F77651	5895010190279	HP7	X			X			
DATA STORAGE GROUP	OL89MYK8	F77918	7025010088928	HON	X			X			
<b>JX ANCILLARY EQUIPMENT</b>											
COMM RESTORE PWR SYS	NONE	Z16417	5811011763877		X			X			
<b>JY DIGITAL COMPUTER SYSTEMS</b>											
DATA PROCESSING SYS	AN/MYQ-4	D78075	7010010906819	HPS	X			X			
DATA PROCESSING SYS	ANMYQ-4A	D78325	7010011585397	HYB	X			X			
<b>K ELECTRONIC TEST EQUIPMENT</b>											
<b>KY MISCELLANEOUS SUPPORT EQUIPMENT</b>											
TEST SUPPORT SYS	AN/TSM-173	T00172	4920011994038	MBP	X		X	X	X		
ENVIRONM TEST CHAMBER	NONE	H11867	6636006210825		X			X			
<b>L FLOATING EQUIPMENT</b>											
<b>LA BARGES</b>											

Figure E-2. Identification of required forms for combat/tactical vehicles and support equipment—Continued

ECC NOUN	MODEL	LIN	NSN	EIC	REG # REQ	2408-4 WPNS REC	2408-5 MWO	2408-9 A/T/L/G	2408-9 USAGE	DD2026 USAGE	2408-9 OVHL
BARGE DECK CARGO	DESIGN 7001	B31060	1930003752967	WCA				X	X		
BARGE (LIQUID CARGO)	231B	B31197	1930003752972	WAI				X	X		
BARGE (CARGO)	750 TON	B30923	1930005864214	WBD	X			X			
BARGE (CARGO)	655 TON	B30923	1930005939583	WBF	X			X			
BARGE PIER DELONG	DSN 7029	N90785	1945009997899	WAT	X			X	X		
BARGE PIER DELONG	DSN 7028	N90665	1945009997900	WAU	X			X	X		
<b>LB BOATS, BRIDGING</b>											
BOAT BRIDGE ERECTION	GD 19	B83445	1940002726400	XKB				X			
BOAT BRIDGE ERECTION	T-15	B83582	1940003554469	XJA				X			
BOAT BRIDGE ERECTION	NONE	B83582	1940004170526	XJC				X			
BOAT BRIDGE ERECTION	MDL 27	B83582	1940005260207	XJD				X			
BOAT BRIDGE ERECTION	MDL 27	B83582	1940007106649	XJF				X			
BOAT BRIDGE ERECTION	HI-WAY	B83582	1940008094472	XJG				X			
BOAT BRIDGE ERECTION	HP127C	B83582	1940009150079	XJH				X			
BOAT BRIDGE ERECTION	USCCBMK1	B25476	1940011055728	XJI				X			
BOAT BRIDGE ERECTION	USCSBMK1	B25476	1940012189185	XJJ				X			
BOAT RECON PNEUMATIC	3-MAN	B84404	1940012493941	XAQ				X			
BRIDGE ERECTION BOAT	M20	B25476	1940014716069	***	X			X	X		
PLT BRDG AD (BAP)	M15	P78313	3990014421939	DDV5	X			X			
BRIDGE, FIXED RAPIDLY	XM21	Z17199	5420014813959	***	X			X	X		
<b>LC BOATS, PASSENGER PICKETS AND UTILITY</b>											
BOAT PICKET	4003	B84130	1940002671099	WAF	X			X			
BOAT PASS/CARGO	2001	B83993	1940002689952	WAG	X			X			
BOAT PICKET	4002	B84267	1940002689955	WAH	X			X			
BOAT UTILITY	26-FT	B84541	1940005546699	WCI	X			X			
BOAT JON ALUMINUM	NONE	B84043	1940010894486		X			X			
BOAT SEMI-VEE ALUM	NONE	B84692	1940010894487		X			X			
CANOE ALUM	NONE	C94690	1940010894488		X			X			
<b>LD LANDING CRAFTS</b>											

Figure E-2. Identification of required forms for combat/tactical vehicles and support equipment—Continued

ECC NOUN	MODEL	LIN	NSN	EIC	REG # REQ	2408-4 WPNS REC	2408-5 MWO	2408-9 A/T/L/G	2408-9 USAGE	DD2026 USAGE	2408-9 OVHL
LANDING CRAFT MECH		L36602	1905001536695	WAJ	X			X	X		
LANDING CRAFT UTILITY	LCU 1646	L36876	19050016885764	WAA	X			X	X		
LANDING CRAFT UTILITY	LCU 1466	L36876	1905002172293	WAB	X			X	X		
LANDING CRAFT MECH		L36739	1905002671097	WAE	X			X	X		
LANDING CRAFT MECH	MDL LCM8	L36739	1905009356057	WAS	X			X	X		
LANDING CRAFT UTILITY	LCU 1646	L36876	1905010091056	WAV	X			X	X		
LANDING CRAFT UTILITY	1466A	L36876	1905010316077	WAW	X			X	X		
LANDING CRAFT UTILITY	MDL2000	L36989	1905011541191	WBS	X			X	X		
LANDING CRAFT MECH	MDL LCM8	L36739	1905012842647	WGC	X			X	X		
LANDING CRAFT MECH		L36739	1905012842648	WGD	X			X	X		
LIGHTER BEACH DISCH	MK1-5002	L67645	1930007059230	WBE	X			X	X		
BOAT LAND INFLT	15-MAN	B83856	1940005405609	XAI				X			
BOAT LAND INFLAT	15-MAN	B83856	1940012493936	XAC				X			
<b>LE TUGS</b>											
TUG 1200-1530 HP	DSN 377A	X71046	1925002161845	WAQ				X	X		
TUG 600-650 HP	DSN 3004	X70909	1925003753002	WAL				X	X		
TUG 1200-1530 HP	DSN 3006	X71046	1925003753003	WAM				X	X		
TUG, LARGE DIESEL	NONE	T68330	1925012477110	WGE	X			X	X		
SMALL TUG	NONE	T68398	1925014351713	WA1				X	X		
TUG WARPING SIDE LOAD	SLWT	W41707	1945012184669	WBO				X			
TUG WARPING MODULAR	MWT	W41775	1945014732285					X			
<b>LF VESSELS</b>											
VESSEL LOGISTIC SPT	LSV-NDI	V00426	1915011538801	WAX				X	X		
<b>LG PROPELLING UNITS, OUTBOARD</b>											
PROPELLING UNIT DED	DSL115HP	P78858	2010000283455	WA6				X	X		
PROPELLING UNIT DED	DSL165HP	P78995	2010002780793	WA7				X	X		
PROPELLING UNIT DED	NA165154	P78995	2010004104442	WAO				X	X		
PROPELLING UNIT DED	OD-250A	P78995	2010012512227	WHD				X	X		

Figure E-2. Identification of required forms for combat/tactical vehicles and support equipment—Continued

ECC NOUN	MODEL	LIN	NSN	EIC	REG # REQ	2408-4 WPNS REC	2408-5 MWO	2408-9 A/T/L/G	2408-9 USAGE	DD2026 USAGE	2408-9 OVHL
<b>LH BARGE CRANES</b>											
CRANE BARGE 89-250T	264	F36090	1935001788205	WBB				X	X		
CRANE BARGE 250T	NONE	F36090	1935002172302	WBC				X	X		
CRANE BARGE 100T	DSN 284B	F36090	1935002646219	WAC				X	X		
<b>LJ BOAT, TRAILERS</b>											
TRLR BOAT TRANS	2-WHEEL	T94691	2330010929238	C82	X			X			
TRLR BOAT TRANS	2-WHEEL	T94759	2330010956915		X			X			
TRLR BOAT TRANS	2-WHEEL	T94759	3920010956915		X			X			
TRLR BOAT COMM	4-WHEEL	W94500	3920011087363	C8D	X			X			
<b>LK BOATS, RECREATIONAL</b>											
BOAT FIBERGLASS	16-FT		1940005527544		X			X			
BOAT FLAT BOTTOM	20-FT	B83793	1940010366831		X			X			
<b>LL LIGHTER, AMPHIBIOUS</b>											
LIGHTER AMPH 60T-SP	LARC-LX	L67508	1930003922981	WAN	X			X	X		
LIGHTER AMPH 5T-SP	LARC	L67234	1930007105728	WAP	X			X	X		
LIGHTER AMPH 15T-SP	LARC-XV	L67371	1930007105729	WAR	X			X	X		
LIGHTER AIR CUSHION V	LARC-XV	NO-LIN	2305010616230	WEA	X			X	X		
<b>LM TRANSPORT MOBILE ASSAULT BRIDGE</b>											
BRIDGE FLOAT	NONE	X23277	5420000715321	XMA	X			X	X	X	
INTERIOR BAY BRDG FLO	NONE	K97376	5420000715322	XMB				X			
SUPSTR END BAY (MAB)	NONE	U58875	5420004916320	XMD				X			
SUPSTR TRNSPTR (MAB)	T52703	U58881	5420004916330	XME	X			X	X	X	
SUPSTR INT BAY (MAB)	NONE	U58878	5420004916339	XMF				X			
RAMP BAY BRIDGE	FLOATING	R10527	5420004975276	XMG				X			
SUPSTR TRNSPTR (MAB)	FMC-1	U58881	5420008778679	XMH	X			X	X	X	
SUPSTR INT BAY (MAB)	NONE	U58878	5420008778682	XMI				X			

Figure E-2. Identification of required forms for combat/tactical vehicles and support equipment—Continued

ECC NOUN	MODEL	LIN	NSN	EIC	REG # REQ	2408-4 WPNS REC	2408-5 MWO	2408-9 A/T/L/G	2408-9 USAGE	DD2026 USAGE	2408-9 OVHL
SUPSTR END BAY (MAB)	NONE	U58875	5420008778684	XMJ				X			
RIBBON BRIDGE	NONE	X23277	5420011756524	XMM	X			X	X	X	
HEAVY ASSULT BRIDGE	AVLB MLC 70	B31098	5420013903933	ARF				X			
HEAVY ASSULT BRIDGE	XM104	H82510	5420014304227	ARD	X			X	X	X	
<b>LX ANCILLARY EQUIPMENT</b>											
REPAIR SHOP FLOATING	DSN 7011	R76483	1935003753000	WBR	X			X	X		
<b>LY MISCELLANEOUS</b>											
BOAT PATROL	42-FT	B84288	1940010514068	WCR	X			X			
JET SKI	NONE	J16401	1940010883530		X			X			
CRADLE BOAT BRDG ERCT	NONE	C34199	2090011069789	XML				X			
IMPROVED BOAT CRADEL	M14 IBC	C33925	3990014421941	DV6	X			X	X		
<b>N CONSTRUCTION EQUIPMENT</b>											
<b>NA CRUSHERS AND PLANTS</b>											
CRUSH/SCREEN/WASH PNT	MDL 2A2	F49673	3820005278577	EWL	X			X	X		
CRUSHER JAW	NONE		3820007837311		X			X			
CRUSHER ROLL	75 TPH		3820007885999		X			X			
CRUSH/SCREEN PLANT	MDL 2A2	F49536	3820008784285	EUW	X			X	X		
CRUSHER JAW	1524PAC		3820008800795	EUX	X			X			
CRUSH/SCREEN PLANT	NONE	F49673	3820014355177	E5G	X			X	X		
CRUSHER JAW	NONE	NO-LIN	3820014357186	***	X			X			
WASH SCREEN UNIT	NONE		3820014357187		X			X			
CRUSHER TERTIARY CONE	NONE	NO-LIN	3820014358022	***	X			X			
CRUSHER ROLL	NONE	NO-LIN	3820014358402	***	X			X			
<b>NB PAVING EQUIPMENT/MIXERS/DISTRIBUTORS</b>											
DIST WTR(GAS-TRK MTD)	W15A4112	G28212	3825000770550	EXS	X			X			
DIST WTR GEN(TRK MTD)	STL 1602	G28212	3825004039334	EXT	X			X			

Figure E-2. Identification of required forms for combat/tactical vehicles and support equipment—Continued

ECC NOUN	MODEL	LIN	NSN	EIC	REG #	2408-4	2408-5	2408-9	2408-9	DD2026	2408-9
					REQ	WPNS REC	MWO	A/T/L/G	USAGE	USAGE	OVHL
DIST WTR (TANK TYPE)	NONE	NO-LIN	3825004318310	EZ8	X			X			
DIST TANK (WTR)	NONE		3825004381485	E2A	X			X			
DIST WTR(GAS-TRK MTD)	W15B	G28212	3825004743742	EX7	X			X			
DIST WTR(GED-TRK MTD)	NONE	G28250	3825006116259	E2D	X			X			
DIST WATER (TRK MTD)	357	G29739	3825006148869	E2E	X			X			
DIST WTR(GAS-TRK MTD)	W15A61A2	G28212	3825007749090	EXZ	X			X			
DIST WTR (STLR MTD)	WD6S	D28318	3825010656221	EVE	X			X			
DIST WTR (SP-NON-SEC)	NONE	D28736	3825011431212	EVG	X			X			
DIST WTR (SP-SEC)	NONE	D28804	3825011431213	EVF	X			X			
DIST WTR (STLR MTD)	R036	D28318	3825012973357	E43	X			X			
PAVING MACH BIT	BARBR GN	N75124	3895000578715	EVM	X			X			
DIST BIT MATRL TANK	D60	G27844	3895000900434	EVS	X			X	X		
MIXER CNCRTE(TRLRMTD)	NONE	M54083	3895004381479	EZ9	X			X	X		
MIXER CNCRTE(TRLRMTD)	NONE	M54076	3895004381480	X	X			X	X		
MIXER CNCRTE(TRLRMTD)	NONE	M54630	3895004381486	E2B	X			X	X		
MIXER CNCRTE(TRLRMTD)	MDL 499A	M54151	3895004441531	EYB	X			X	X		
DIST BIT (SEAMAN)	NONE		3895004592484	EYU	X			X			
DRIER MXR BIT(WHLMTD)	PM 415	G55186	3895007554761	EWN	X			X			
DIST LIQ BIT (TLRMTD)	NONE	G27938	3895007670247	EYS	X			X			
MIXER CNCRTE(TRLRMTD)	MAC 16SM	M54151	3895008077985	EYC	X			X			
PAVING MACH BIT	BG 879-B	N75124	3895008216951	EZW	X			X			
DRIER MXR BIT(WHLMTD)	700LA	G55186	3895008326230	EWT	X			X			
MIXER CNCRTE(TRLRMTD)	H6G	M54151	3895008354512	EYD	X			X			
DIST BIT(GAS-TRK MTD)	D-40	G27684	3895008492116	EY3	X			X			
MIXER RTY TILLER (SP)	B2-1171	M55384	3895008830437	EYV	X			X			
MIXING PLANT-ASPHALT	ELECKA60	M57048	3895009368613	EY6	X			X			
MIXER CNCRTE(TRLRMTD)	MAC 16SM	M54151	3895009855335	EYE	X			X			
MIXER RTY TILLER (SP)	HDTM	M55384	3895009875536	EW8	X			X			
DIST BIT (TRK MTD)	NONE		3895010261237	EZE	X			X			
DISTR BIT MATRL TANK	M918	G27844	3895010284390	EXC	X			X	X	X	
MIXER CNCRTE(TRLR MTD)	ELEC	M54254	3895010525058	X	X			X			
PAVING MACH BIT	BSF400	N75124	3895010637891	EXE	X			X			
PAVING MACH	NONE		3895010929232	X	X			X			

Figure E-2. Identification of required forms for combat/tactical vehicles and support equipment—Continued

ECC NOUN	MODEL	LIN	NSN	EIC	REG #	2408-4	2408-5	2408-9	2408-9	DD2026	2408-9
					REQ	WPNS REC	MWO	A/T/L/G	USAGE	USAGE	OVHL
PATCH UT MOBILE-ASPH	NONE	P07602	3895011374852	E4E	X			X			
MIXER RTY TILLER (SP)	HDS-E	M55384	3895011410882	EXG	X			X			
MIXER RTY TILLER (SP)	T0730	M55384	3895013318550	E45	X			X			
DIST LIQ BIT	NONE	G27938	3895013445480	E4Z	X			X			
MIXING PLANT-ASPHALT	150 TPH	M57048	3895013692551	E46	X			X			
PAVING MACHING IR	MDL 780T	N75124	3895013791102	E47	X			X			
DIST BIT SPDR	M4	S13546	3990014446174	BDP	X			X			
<b>NC EARTHMOVING</b>											
COMBAT EARTHMOVER	DEUCE	T76541	2430014232819	EBZ	X		X	X	X		
BLDZR EARTH MVG	M9	C36120	2590007083563	ASB	X			X			
BLDZR EARTH MVG	M8A3		2590009444903	ASC	X			X			
SCRAPER (TOWED)	EUC 58-H	S56256	3805000693316	EHX	X		X	X	X		
SCRAPER (LET)	WHSE CT4	S56256	3805000753312	EHY	X		X	X	X		
SCRAPER EARTHMOVING	TOWED	S56393	3805003519542	EHR	X			X	X		
SCRAPER AIR DROPPABLE	NONE	S56941	3805004180115	EHW	X			X	X		
SCRAPER AIR/TRANS/SEC	NONE	S56119	3805004180116	EH4	X			X	X		
SCRAPER EARTHMOVING	W-CWT 18M	S56804	3805006786359	EHT	X			X	X		
SCRAPER EARTHMOVING	AR-775	S56941	3805008117671	EHU	X			X	X		
SCRAPER EARTHMOVING	AR-755B	S56941	3805008592486	EHV	X			X	X		
SCRAPER EARTHMOVING		S56119	3805009974344	EJP	X			X	X		
SCRPR EARTHMOVING-SP	11-15 CU YD	S55996	3805011050782	EH8	X			X	X		
SCRPR EARTHMOVING-SP	9-CU YD	S55966	3805011062083	EH7	X			X	X		
SCRPR EARTHMOVING-SP	18-22 CU YD	S56006	3805011062084	EH6	X			X	X		
SCRPR	4-1/2 YD	S56882	3805011190241	EH5	X			X	X		
SCRAPER ELEV NON-SECT	NONE	S29971	3805011442992	EHZ	X			X	X		
SCRAPER ELEV SECT	NONE	S30039	3805011448837	EH2	X			X	X		
SCRPR EARTHMOVING-SP	CAT 621B	S56246	3805011531854	EH3	X		X	X	X		
SCRAPER SP-ELEV SECT	613BS5	S30039	3805012674177	EJK	X		X	X	X		
SCRAPER SP-ELEV/NON-S	613BSNS	S29971	3805012674178	EJL	X		X	X	X		

ND TRACTORS

Figure E-2. Identification of required forms for combat/tactical vehicles and support equipment—Continued



ECC NOUN	MODEL	LIN	NSN	EIC	REG # REQ	2408-4 WPNS REC	2408-5 MWO	2408-9 A/T/L/G	2408-9 USAGE	DD2026 USAGE	2408-9 OVHL
TRACTOR (FT-LOW SPD)	HO-16M	W76816	2410000786483	EA5	X			X	X		
TRACTOR (FT-LOW SPD)	HD16-M	W83529	2410000786484	EAT	X			X	X		
TRACTOR (FT-LOW SPD)	JD850B	W88509	2410001379194	EBG	X			X	X		
TRACTOR (FT-LS ELECT)	D5A	W76268	2410001425283	EAN	X			X	X		
TRACTOR (FT-LOW SPD)	NONE	W86200	2410001776851	EBH	X			X	X		
TRACTOR (FT-LOW SPD)	1150	Y99990	2410001777041		X			X	X		
TRACTOR (FT-LOW SPD)	NONE	T88775	2410001777091	EBJ	X			X	X		
TRACTOR (FT-LOW SPD)	D7F DV29	W83529	2410001777283	EAU	X			X	X		
TRACTOR (FT-LOW SPD)	D7F DV29	W76816	2410001777284	EA2	X			X	X		
TRACTOR (FT-LOW SPD)	D7F/ROPS	W76816	2410001859792	EA6	X			X	X		
TRACTOR (FT-LOW SPD)	D7F/ROPS	W83529	2410001859794	EAV	X			X	X		
TRACTOR (FT-LOW SPD)	D5	W76268	2410002302767	EAP	X			X	X		
TRACTOR (FT-LOW SPD)	D7F	W76816	2410003006664	EA7	X			X	X		
TRACTOR (FT-LOW SPD)	D7F	NO-LIN	2410003006665	EAX	X			X	X		
TRACTOR (FT-LOW SPD)	NONE	W88493	2410004511003	EBK	X			X	X		
TRACTOR (FT-LOW SPD)	TD18-182	W83255	2410005417654	EBP	X			X	X		
TRACTOR (FT-LOW SPD)	TD18-182	W80789	2410005417655	EAF	X			X	X		
TRACTOR (FT-LOW SPD)	TD-24241	W77364	2410005422338	EBQ	X			X	X		
TRACTOR (FT-LOW SPD)	TD20-200	W80789	2410005422498	EBR	X			X	X		
TRACTOR (FT-LOW SPD)	TD20-200	W83255	2410005422499	EAE	X			X	X		
TRACTOR (FT-LOW SPD)	W/A D-8		2410005424881	EAA	X			X	X		
TRACTOR (FT-LOW SPD)	CAT D-8	W77364	2410005424882	EAB	X			X	X		
TRACTOR (FT-LOW SPD)	D8K8A-58	W88575	2410005747597	EAC	X			X	X		
TRACTOR (FT-LOW SPD)	D8K-8S-8	W88699	2410005747598	EAD	X			X	X		
TRACTOR (FT-LOW SPD)	CAT D7E	W76816	2410007821130	EA3	X			X	X		
TRACTOR (FT-LOW SPD)		W83255	2410008283083	EAM	X			X	X		
TRACTOR (FT-LOW SPD)	D5A-GAS	W76268	2410008286865	EAQ	X			X	X		
TRACTOR (FT-LOW SPD)		W80515	2410008374224	EAG	X			X	X		
TRACTOR (FT-LOW SPD)	NONE	W80104	2410008436374	EAH	X			X	X		
TRACTOR (FT-LOW SPD)	D6B	W76268	2410009008539	EAR	X			X	X		
TRACTOR (FT-LOW SPD)	HD-16M	W76816	2410009011950	EA4	X			X	X		
TRACTOR (FT-LOW SPD)	NONE	W80378	2410009260910	EAL	X			X	X		
TRACTOR (FT-LOW SPD)	CAT D7E	W83529	2410009263697	EAV	X			X	X		

Figure E-2. Identification of required forms for combat/tactical vehicles and support equipment—Continued

ECC NOUN	MODEL	LIN	NSN	EIC	REG # REQ	2408-4 WPNS REC	2408-5 MWO	2408-9 A/T/L/G	2408-9 USAGE	DD2026 USAGE	2408-9 OVHL
TRACTOR (FT-LOW SPD)	M450	W76336	2410009350714	EAS	X			X	X		
TRACTOR (FT-LOW SPD)		W80515	2410009838024	EAJ	X			X	X		
TRACTOR (FT-LOW SPD)	1150W/R	W76285	2410010244065	EA8	X			X	X		
TRACTOR (FT-LOW SPD)	D7E(WIN)	W76816	2410010509628	EA9	X			X	X		
TRACTOR (FT-LOW SPD)	D7E(RIP)	W83529	2410010509629	EAY	X			X	X		
TRACTOR (FT-LOW SPD)	NONE	W86200	2410011098003	EBN	X			X	X		
TRACTOR (FT-LOW SPD)	D5BNS	W76285	2410011267902	EBA	X			X	X		
TRACTOR (FT-LOW SPD)	D5BS	W76268	2410011276512	EBB	X			X	X		
TRACTOR (FT-LOW SPD)	MDL 550C	W76336	2410011399859	EBC	X			X	X		
TRACTOR (FT-LOW SPD)	D7GWR/ROPS	W83529	2410012230350	EAZ	X			X	X		
TRACTOR (FT-LOW SPD)	CAT D7G	W76816	2410012237261	EBM	X			X	X		
TRACTOR (FT-LOW SPD)	D7G	W76816	2410012532117	EBV	X			X	X		
TRACTOR (FT-LOW SPD)	D7G	W83529	2410012532118	EBW	X			X	X		
TRACTOR (FT-LOW SPD)	D5BS1	W76268	2410012701192	EBS	X			X	X		
TRACTOR (FT-LOW SPD)	D5BNS1	W76285	2410012968479	EBT	X			X	X		
TRACTOR (FT-LOW SPD)	JD450G	W76336	2410014120930	EBU	X			X	X		
TRACTOR (FT-LOW SPD)		W83529	2410014230930	EBX	X			X	X		
TRACTOR (FT-LOW SPD)	D7H	W76816	2410014230931	EBY	X			X	X		
TRACTOR (FT-LOW SPD)	D7R	W83529	2410014514048	EB2	X			X	X		
TRACTOR (WHL IND)	DSL-290M	W90790	2420000889384	EDA	X			X	X		
TRACTOR (WHL IND)	DSL830MB	W90790	2420001041896	EDB	X			X	X		
TRACTOR (WHL AGRIC)	NONE	W88758	2420001776861	EEA	X			X	X		
TRACTOR (WHL IND)	4199DB	W89604	2420001776862	ED9	X			X	X		
TRACTOR (WHL AGRIC)	NONE	W88781	2420001776863	ED8	X			X	X		
TRACTOR (WHL IND)	5699DB	W89607	2420001776864	ED7	X			X	X		
TRACTOR (WHL AGRIC)	5699	W88786	2420001776865	ED6	X			X	X		
TRACTOR (WHL IND)	7299DB	W89610	2420001776866	ED5	X			X	X		
TRACTOR (WHL AGRIC)	7299	W88791	2420001776867	ED4	X			X	X		
TRACTOR (WHL IND)	7300DB	W89613	2420001776868	ED3	X			X	X		
TRACTOR (WHL AGRIC)	7300	W88796	2420001776869	ED2	X			X	X		
TRACTOR (WHL)	5175D1	W92160	2420002670115	EDN	X			X	X		
TRACTOR (GAS-WHL IND)	NONE	W91201	2420002670136	EDE	X			X	X		
TRACTOR (WHL IND)	RTI	W91201	2420002676887	EDF	X			X	X		

Figure E-2. Identification of required forms for combat/tactical vehicles and support equipment—Continued

ECC NOUN	MODEL	LIN	NSN	EIC	REG # REQ	2408-4 WPNS REC	2408-5 MWO	2408-9 A/T/L/G	2408-9 USAGE	DD2026 USAGE	2408-9 OVHL
TRACTOR (GAS-WHL IND)	CASE S1	W91201	2420002690802	EEB	X			X	X		
TRACTOR (GAS-WHL IND)	MDL ZASI	W92160	2420002777495	EDP	X			X	X		
TRACTOR (DSL-WHL IND)	MDL 100	W90927	2420004156132	EDJ	X			X	X		
TRACTOR(WHL-HIGH SPD)	NONE	W88940	2420004318309	EDY	X			X	X		
TRACTOR (DSL-WHL IND)	M 480 CK	W76302	2420004345309	EDG	X			X	X		
TRACTOR (GAS-WHL IND)	MDL 1244G	W92160	2420005416689	EDQ	X			X	X		
TRACTOR (GAS-WHL IND)	MDL 770	W92160	2420005423340	EDR	X			X	X		
TRACTOR (WHL HIGH SP)	JD-410	W91074	2420005670135	EDH	X			X	X		
TRACTOR (GAS-WHL IND)	455-M	W92708	2420005807019	EDM	X			X	X		
TRACTOR (WHL IND)	DSL	W90927	2420007926163	EDK	X			X	X		
TRACTOR (DSL-WHL IND)	830M	W91064	2420008060031	EE3	X			X	X		
TRACTOR (GAS-WHL IND)	1HC-460	W92708	2420008562412	EEC	X			X	X		
TRACTOR (DSL-WHL IND)	NONE	W76302	2420009008538	EDS	X			X	X		
TRACTOR (DSL-WHL IND)	MRS	W90447	2420009023084	EEY	X			X	X		
TRACTOR (DSL-WHL IND)	CAT830MB	W90790	2420009305999	EDC	X			X	X		
TRACTOR (DSL-WHL IND)	830MBROP	W90790	2420010064946	EEZ	X			X	X		
TRACTOR (DSL-WHL IND)	830MBROP	W90790	2420010284936	EE2	X			X	X		
TRACTOR (DSL-WHL IND)	290MROPS	W90790	2420010590090	EDD	X			X	X		
TRACTOR (WHL IND)	3599DB		2420010590091	EDZ	X			X	X		
TRACTOR (WHL IND)	25M DBP	T89190	2420010630254	EDX	X			X	X		
TRACTOR (WHL HIGH SP)	TREESPAD		2420011064451	EDV	X			X	X		
TRACTOR (WHL IND)	EXCAV	T34437	2420011602754	EDL	X			X	X		
TRACTOR(WHL IND-HMMH)	FLU10344	T33786	2420012058636	EED	X			X	X		
TRACTOR (WHL IND)	NONE		2420012288610	X	X			X	X		
TRACTOR (WHL IND)	NONE		2420012560066	X	X			X	X		
TRACTOR (WHL IND)	MT5	NO-LIN	2420013666796	***	X			X	X		
<b>NE GRADERS</b>											
GRADER ROAD MOTORIZED		J74852	3805000538448	EHA	X			X	X		
GRADER ROAD MOTORIZED	F1500M	J74852	3805001557093	EHE	X		X	X	X		
GRADER ROAD MOTORIZED	NONE		3805001949823	X	X			X	X		
GRADER ROAD MOTORIZED	12	J74852	3805001974184	EJG	X		X	X	X		

Figure E-2. Identification of required forms for combat/tactical vehicles and support equipment—Continued

ECC NOUN	MODEL	LIN	NSN	EIC	REG # REQ	2408-4 WPNS REC	2408-5 MWO	2408-9 A/T/L/G	2408-9 USAGE	DD2026 USAGE	2408-9 OVHL
GRADER ROAD MOTORIZED	116	J74852	3805002211802	EJM	X			X	X		
GRADER ROAD MOTORIZED	550	J74852	3805002239030	EJN	X			X	X		
GRADER ROAD MOTORIZED	118	J74852	3805002239031	EJR	X			X	X		
GRADER ROAD MOTORIZED		J74852	3805002239037	EHB	X			X	X		
GRADER ROAD MOTORIZED	MDL 120		3805004660084	X	X			X	X		
GRADER ROAD MOTORIZED	NONE	J74852	3805005422995	EHC	X			X	X		
GRADER ROAD MOTORIZED	4D	J74852	3805005422996	EHD	X			X	X		
GRADER ROAD-AIR DROP	NONE	J74920	3805007825290	EHG	X			X	X		
GRADER ROAD MOTORIZED	MDL 112	J74886	3805009023083	EEL	X			X	X		
GRADER ROAD MOTORIZED	440HA		3805009317881	X	X		X	X	X		
GRADER ROAD MOTORIZED	6X4-1000LBS	J74910	3805009954772	EJD	X			X	X		
GRADER ROAD MOTORIZED	440HA	J74852	3805010182866	EHJ	X		X	X	X		
GRADER ROAD MOTORIZED	CAT 120	J74852	3805010290139	EHK	X		X	X	X		
GRADER ROAD MOTORIZED	NONE	J74886	3805010290140	EHL	X			X	X		
GRADER ROAD MOTORIZED	DED/GED	G74978	3805010632012	EJE	X			X	X		
GRADER ROAD MOTORIZED	F1500MW	J74852	3805010643878	EHM	X		X	X	X		
GRADER ROAD MOTORIZED	130GNS	J74920	3805011267894	EHN	X			X	X		
GRADER ROAD MOTORIZED	130GS	J74886	3805011267895	EHP	X		X	X	X		
GRADER ROAD MOTORIZED	CAT 130G	G74783	3805011504795	EHF	X		X	X	X		
GRADER ROAD MOTORIZED	130GSCE	J74886	3805012518252	EJH	X			X	X		
GRADER ROAD MOTORIZED	130GNSCE	J74920	3805012520128	EJJ	X			X	X		
GRADER SCRAPER ATTACH	NONE	J75239	3830009008545	EHQ	X			X			
<b>NF CRANES/SHOVELS/EXCAVATORS</b>											
EXCAVATOR (TRUCK MTD)	NONE	H17945	3805003519426	E24	X			X	X		
EXCAVATOR (TRUCK MTD)	NONE	E27292	3805012171083	E2Y	X			X	X		
EXCAVATOR (TRUCK MTD)	NONE	H17945	3805012178422	E22	X			X	X		
EXCAVATOR, MULTIPURP	LS2800LF	E18094	3805013465615	***	X			X	X		
EXCAVATOR, MULTIPURP	JD 230LCR	E27792	3805014630804	E5L	X			X	X		
EXCAVATOR, MULTIPURP	JD 330LCR	E27860	3805014630805	E5N	X			X	X		
EXCAVATOR, MULTIPURP	JD 230LC-RD	E41791	3805014630806	E5M	X			X	X		
CRANE (TRK MTD) 25T	MT 250	F43429	3810000182021	ELA	X		X	X	X		

Figure E-2. Identification of required forms for combat/tactical vehicles and support equipment—Continued

ECC NOUN	MODEL	LIN	NSN	EIC	REG # REQ	2408-4 WPNS REC	2408-5 MWO	2408-9 A/T/L/G	2408-9 USAGE	DD2026 USAGE	2408-9 OVHL
CRANE (WHL MTD) 20T	2385	F39378	3810000435354	EK5	X		X	X	X		
CRANE (WHL MTD)	TELE	C36287	3810000608962	EKN	X			X	X		
CRANE-SHOVEL(TRK MTD)	M320T2	F43414	3810001514431	ELF	X		X	X	X		
CRANE (TRK MTD) 100T		F38806	3810002302774	ELN	X			X	X		
CRANE (WHL MTD) 20T	M320RT	F39378	3810002751167	EKC	X		X	X	X		
CRANE (TRK MTD)10-25T	200RF2	F43439	3810003503775	EKM	X		X	X	X		
CRANE (TRK MTD)	AJAMAIN	F43003	3810004337174	ELK	X			X	X		
CRANE (TRK MTD)30-45T	NONE	F38738	3810004571525	ELP	X			X	X		
CRANE (TRK MTD)50-65T	NONE	F38783	3810004571526	ELQ	X			X	X		
CRANE-SHOVEL (TRK MTD	M-20-A(F)	F43414	3810005278613	ELC	X			X	X		
CRANE-SHOVEL	M855BG2	F40474	3810005423048	EMH	X		X	X	X		
CRANE-SHOVEL(TRK MTD)	M855BG240T	F40474	3810005423049	EMC	X			X	X		
CRANE-SHOVEL(TRK MTD)	M200	F43414	3810005424982	ELE	X		X	X	X		
CRANE (CRAWLER MTD)		F36354	3810005717030	EML	X			X	X		
CRANE SHOVEL (TRK MTD	M855BG240T	F40474	3810006068569	EMD	X			X	X		
CRANE(WHL MTD)12-1/2T	NONE	F39319	3810006148850	EKH	X		X	X	X		
CRANE (CRAWLER MTD)	1125	F36364	3810007017324	EMM	X			X	X		
CRANE (CRAWLER MTD)	1125WZD	F36364	3810007289945	EMN	X			X	X		
CRANE (WHL MTD) 20T	2380	F39378	3810007637728	EKD	X		X	X	X		
CRANE-SHOVEL	M855BG340T	F40474	3810007865200	EMJ	X			X	X		
CRANE (WHL MTD)	GW7	F43077	3810008152308	EKJ	X			X	X		
CRANE (WHL MTD)	155-1A	F43077	3810008183381	EKK	X			X	X		
CRANE (WHL MTD) 5-T	H-446A	F43067	3810008592404	EKL	X		X	X	X		
CRANE-SHOVEL(TRK MTD)	M320T	F43414	3810008618088	ELG	X		X	X	X		
CRANE-SHOVEL	22BM	F43364	3810008693092	EMA	X		X	X	X		
CRANE (WHL MTD) 3-T	M63	F39172	3810009023082	EKF	X			X	X		
CRANE (WHL MTD) 3-T	M-65	F39172	3810009215055	EKP	X		X	X	X		
CRANE-SHOVEL	855BG2	F40474	3810009330588	EME	X		X	X	X		
CRANE-SHOVEL	855BG	F40474	3810009330589	EMF	X		X	X	X		
CRANE-SHOVEL	36M	F43364	3810009373939	EMB	X		X	X	X		
CRANE (WHL MTD) 5T	H-446	F39241	3810009480407	EKT	X		X	X	X		
CRANE-SHOVEL(TRK MTD)	2360	F43414	3810009890505	ELM	X		X	X	X		
CRANE (TRK MTD) 25T	TMS300-5	F43429	3810010549779	ELH	X		X	X	X		

Figure E-2. Identification of required forms for combat/tactical vehicles and support equipment—Continued

ECC NOUN	MODEL	LIN	NSN	EIC	REG # REQ	2408-4 WPNS REC	2408-5 MWO	2408-9 A/T/L/G	2408-9 USAGE	DD2026 USAGE	2408-9 OVHL
CRANE (CRAWLER MTD)	15-35 TON	F36354	3810011095931	EMP	X			X	X		
CRANE (TRK MTD)	RT41AA	F43003	3810011444885	ELL	X		X	X	X		
CRANE-SHOVEL	P&H 5060	F40474	3810011458288	EMK	X		X	X	X		
CRANE(WHL MTD) 7 1/2T	NONE	C36151	3810011650646	EKY	X		X	X	X		
CRANE(WHL MTD) 7 1/2T	NONE	C36219	3810011650647	EKZ	X		X	X	X		
CRANE (WHL MTD-RTCC)	NONE	C39398	3810012052716	EKG	X		X	X	X		
CRANE (TRK MTD) 25T	T AT422T	C36586	3810014482619	ELT	X		X	X	X		
CRANE (WHL MTD)	RT875CC	NO-LIN	3810014971001	***	X			X	X		
CRANE ATTACH(TRK MTD)	174A	F35816	3930009730660	DJM	X		X	X	X		
<b>NG LOADERS</b>											
LOADER SCOOP (DSL)	AC 645M	L76321	3805000519359	EFL	X		X	X	X		
LOADER SCOOP (DSL)	NONE	L76282	3805000746378	DJA	X		X	X	X		
LOADER SCOOP (DSL)	MW24B	L76321	3805001694711	EFM	X		X	X	X		
LOADER SCOOP (DSL)	MW24	L76556	3805002530627	EFN	X		X	X	X		
LOADER SCOOP(DED/GED)	NONE	L76305	3805004381463	EF4	X			X	X		
LOADER SCOOP (DSL)	NONE	L76522	3805004381464	EF5	X			X	X		
LOADER SCOOP (FT-DSL)	NONE	L76738	3805004381483	EF6	X			X	X		
LOADER SCOOP (DSL)	NONE	L76328	3805004381484	X	X			X	X		
LOADER ROCK BUCKET	CLRK175B	L76315	3805006025006	EFB	X		X	X	X		
LOADER SCOOP (DED)	CLRK175B	L76321	3805006025013	EFC	X		X	X	X		
LOADER SCOOP (DSL)	S645M	L76556	3805006177091	EFP	X		X	X	X		
LOADER SCOOP (FT)	9M45OL	W80652	3805006211392	EF7	X		X	X	X		
LOADER	175A-M	L76488	3805006781735	EFF	X		X	X	X		
LOADER SCOOP (DSL)	85A-M	L76351	3805006796915	EFD	X		X	X	X		
LOADER SCOOP (GED)	3/8 YD	L76659	3805007219453	EF8	X			X	X		
LOADER SCOOP (DSL)	1 1/2CYD	L76351	3805007611640	EFE	X			X	X		
LOADER SCOOP (DSL)	H-90M	L76625	3805008032671	EFK	X			X	X		
LOADER SCOOP (FT-DSL)	1 1/2CYD	L76725	3805008573599	EF9	X			X	X		
LOADER SCOOP (DSL)	175A-M23	L76625	3805008663849	EFG	X			X	X		
LOADER SCOOP	NONE	L76693	3805009008546	EFA	X		X	X	X		
LOADER SCOOP (DSL)	H-90CM	L76625	3805009953236	EFJ	X		X	X	X		

Figure E-2. Identification of required forms for combat/tactical vehicles and support equipment—Continued

ECC NOUN	MODEL	LIN	NSN	EIC	REG # REQ	2408-4 WPNS REC	2408-5 MWO	2408-9 A/T/L/G	2408-9 USAGE	DD2026 USAGE	2408-9 OVHL
LOADER SCOOP (DSL)	MW24	L76556	3805010302816	EFT	X			X	X		
LOADER ROCK BUCKET	H100CRB	L76315	3805010529042	EFR	X		X	X	X		
LOADER SCOOP (DED)	H100CGPB	L76321	3805010529043	EF5	X		X	X	X		
LOADER SCOOP	ACTL645 ROPS	L76693	3805010645800	EFU	X			X	X		
LOADER SCOOP (DED)	NONE	L80902	3805010667763	EGA	X		X	X	X		
LOADER SCOOP (SEC)	950BS	L76693	3805011267914	EFV	X		X	X	X		
LOADER SCOOP (DSL)	950BNS	L76556	3805011267915	EFW	X		X	X	X		
LOADER SCOOP (DSL)	MW24C	L76556	3805011504814	EFQ	X		X	X	X		
LOADER SCOOP (SEC)	950BSCE	L76693	3805012605162	EGF	X		X	X	X		
LOADER SCOOP (DSL)	950BNSCE	L76556	3805012605163	EGG	X		X	X	X		
LOADER TRANS (CARGO)	36000 LBS	L77012	3930011448666	DVR	X			X	X		
<b>NH ROLLERS</b>											
ROLLER (TOWED)	RT-100	S12438	3895000334986	ET6	X			X			
ROLLER (MTZD)	4-6 TON		3895001514429	EZV	X			X			
ROLLER (MTZD-DED/GED)	NONE	S11054	3895001731728	E4N	X			X			
ROLLER (MTZD-GAS)	KT-16B	S11068	3895001948536	EV6	X			X			
ROLLER	CHIEF	S11479	3895001948551	EXL	X			X			
ROLLER (MTZD-GAS)	T5-G	S11068	3895002211632	EV7	X			X			
ROLLER (TOWED)	TR13	S12164	3895002309684	ETD	X			X			
ROLLER SHEEPSFOOT	MD-96	S12575	3895002413542	ETS	X			X			
ROLLER SHEEPSFOOT	WH W-2	S12575	3895002506054	ET2	X			X			
ROLLER (MTZD-DED)	NONE	S11650	3895002509553	EZ7	X			X			
ROLLER (VIB-DED/GAS)	VR55TM	S10682	3895002525276	EUJ	X			X			
ROLLER (MTZD-GAS)	1503	S11616	3895002555054	EUG	X			X			
ROLLER(MTZD-STL WHLD)	C350BD	S11711	3895005780372	ET5	X			X			
ROLLER(MTZD-AIR TRAN)	SP-2800	S11684	3895008326232	ET9	X			X			
ROLLER (TOWED)	R13S	S12164	3895008365243	ETG	X			X			
ROLLER (MTZD-GAS)	T58M	S11068	3895008425326	EU8	X			X			
ROLLER (TOWED)	HP4-36		3895008467519	E4T	X			X			
ROLLER (TOWED)	35-4T	S12301	3895008661617	EVJ	X			X			
ROLLER (SHEEPSFOOT)	TWD-MI7	S10657	3895009023110	EZD	X			X			

Figure E-2. Identification of required forms for combat/tactical vehicles and support equipment—Continued

ECC NOUN	MODEL	LIN	NSN	EIC	REG # REQ	2408-4 WPNS REC	2408-5 MWO	2408-9 A/T/L/G	2408-9 USAGE	DD2026 USAGE	2408-9 OVHL
ROLLER (MTZD-GAS)	E-1012-M	S11616	3895009028455	EUD	X			X			
ROLLER (MTZD-GED)	2 RLS		3895009357909	E2G	X			X			
ROLLER (MTZD-GAS)	T5-8G	S11068	3895009548181	EVR	X			X			
ROLLER SHEEPSFOOT	H2S	S12575	3895009679021	ETY	X			X			
ROLLER SHEEPSFOOT	M2-6TM	S12575	3895009703380	ETZ	X			X			
ROLLER (TOWED)	HP4-35A	S12301	3895009843076	EVU	X			X			
ROLLER (MTZD-GAS)	E-1012MR	S11616	3895009976099	EUE	X			X			
ROLLER (VIB-SP)	RS28	S12916	3895010128875	EUP	X			X			
ROLLER (PNEU-SP)	C530A	S11793	3895010133630	EUR	X			X			
ROLLER (MTZD)	3 RLS		3895010170960	E2H	X			X			
ROLLER (VIB-SP)	SP848	S12916	3895010752823	EUU	X			X			
RECYCLER ASPHALT	NONE	R52409	3895011075767	X	X			X			
ROLLER (SMOOTH DRUM)	TWD-SM54	S10682	3895011934078	EUN	X			X			
ROLLER (VIB-SP)	NONE	R13099	3895012165610	E2X	X			X			
ROLLER (MTZD-CAT)	CB534B	S11711	3895013962822	E5B	X			X			
ROLLER, MOTORIZED	TYPE I	R13167	3895014562733	E5H	X			X			
ROLLER, MOTORIZED	TYPE II	R19753	3895014562734	E5K	X			X			
ROLLER, MOTORIZED	TYPE III	R11127	3895014562735	E5J	X			X			
ROLLER, MOTORIZED	NONE	S11711	3895015024005	***	X			X			
<b>NJ DRILLS</b>											
DRILL PNEU	NONE		3820004105549		X			X			
DRILL PNEU(CRWLR MTD)	MS5450AD	G58700	3820004453766	E9C	X			X		X	
TRK WELL DRILL SPT	NONE	T94171	3820011784980	ZJM	X			X		X	
DRILL MACH (TRK MTD)	NONE	D95754	3820011785057	ZJO	X			X		X	
<b>NK BRIDGES, ERECTION AND FERRY</b>											
BRIDGE ERECT SET	CLASS 60	C22332	5420002670029	XJN				X			
BRIDGE ERECT SET	NONE	C22195	5420002929836	XJP				X			
BRIDGE ERECT SET	CLASS 60	C26305	5420008924596	XJT				X		X	
<b>NL BRIDGES, ARMOR VEHICLE LAUNCH</b>											

Figure E-2. Identification of required forms for combat/tactical vehicles and support equipment—Continued

ECC NOUN	MODEL	LIN	NSN	EIC	REG # REQ	2408-4 WPNS REC	2408-5 MWO	2408-9 A/T/L/G	2408-9 USAGE	DD2026 USAGE	2408-9 OVHL
BRIDGE ARMOR	AVLSC60	C20414	5420005229599	ARA				X			
<b>NM SPREADERS (ALL TYPES)</b>											
SPREADER SEEDER	NONE	U12484	3750005279446		X			X			
SPREADER LOOSE MAT	NONE	U12206	3750009650043		X			X			
SPREADER LOOSE MAT	NONE	U12205	3830006227331	EZ3	X			X			
SPRDR AGGREGATE (TWD)	FF-8	U12063	3895001303633	EVT	X			X			
SPRDR AGGREGATE (TWD)	M58FT	U12063	3895008367324	EWWW	X			X			
SPREADER AGGREGATE	SA8430E	U12063	3895013295096	E4X	X			X			
<b>NN TRUCKS (CCE)</b>											
TRUCK DUMP (CCE)	F5070	X44403	3805001927249	EZY	X			X	X	X	X
TRUCK DUMP (CCE)	M917	X44403	3805010284389	EZZ	X			X	X	X	X
TRUCK DUMP	M917A1	X44403	3805014311165	E5C	X			X	X	X	X
TRUCK DUMP(W/MCS)	M917A1 W/MCS	X44403	3805014328249	E5D	X			X	X	X	X
TRUCK DUMP	M917A2 W/MCS	NO-LIN	3805014886963	***	X			X	X	X	X
TRUCK DUMP	M917A2	NO-LIN	3805014887442	***	X			X	X	X	X
TRK CNCRTE MXR (CCE)	M919	T42725	3895010284391	EXD	X			X	X	X	X
<b>NO BRIDGES, FLOATING</b>											
BRIDGE FLOATING	CL60/135	C25346	5420000599082	XJU				X			
BRDG FLOAT-ALUM DECK	NONE	C25072	5420001714519	XJK				X			
BRIDGE FLOATING	CL60/600	C25209	5420002670012	XJM				X			
<b>NP KETTLES, HEATING BITUMINOUS</b>											
HEATER (GAS-TRLR MTD)	PSM50	K24520	3895000627912	EVP	X			X			
HEATER BITUMINOUS	NONE		3895000995342	EXH	X			X			
KETTLE (GAS-TRLR MTD)	7ZPSA	L21437	3895002477593	EVZ	X			X			
KETTLE (GAS-TRLR MTD)	GS 1901	L21437	3895003512354	EV5	X			X			
KETTLE (GAS-TRLR MTD)	FM 3-1	L21437	3895004429741	EV9	X			X			
KETTLE HEAT (TLR MTD)	CIM200		3895006009323	EYM	X			X			

Figure E-2. Identification of required forms for combat/tactical vehicles and support equipment—Continued

ECC NOUN	MODEL	LIN	NSN	EIC	REG # REQ	2408-4 WPNS REC	2408-5 MWO	2408-9 A/T/L/G	2408-9 USAGE	DD2026 USAGE	2408-9 OVHL
KETTLE (GAS-TRLR MTD)	72PSA967	L21437	3895008326231	EWJ	X			X			
HEATER BITUMINOUS	SG 52A		3895008365242		X			X			
HEATER OIL (TRLR MTD)	NONE	K25215	3895008389180	EZB	X			X			
HEATER OIL (TRLR MTD)	200STM77	K25215	3895010637892	EZC	X			X			
KETTLE, HEATING, BIT	NONE		3895010693372	EZF	X			X			
KETTLE HEAT ASPHALT	KT130-6		3895010907755	EZG	X			X			
KETTLE (GAS-TRLR MTD)	TPS-165A	L21437	3895012076347	E4U	X			X			
HEATER DUCT (PTBL)	T400401A	K24931	4520002233221	VXC	X			X			
HEATER DUCT (PTBL)	400-40-1	K24931	4520009157789	VXF				X			
HEATER DUCT (PTBL)	FC-400-1	K24931	4520010717191	VXH				X			
HEATER DUCT (PTBL)	CW400-4	K24931	4520011659477	VX5	X			X			
<b>NU CONVEYOR/ELEVATORS</b>											
CONVEYOR (PRODUCT)	NONE		3820014358025		X			X			
<b>NV SPECIAL/MISCELLANEOUS</b>											
SHEDDER BUSH TRLR MTD	NONE		2330010907609	E2J	X			X			
BENDER (PANEL MACH)	NONE	B61824	3441013050439		X			X			
BENDER MACH	SUPER K		3441013537526		X			X			
SHREDDER (TRLR MTD)	NONE		3680011128363	E3J	X			X			
HARROW DISK (8FT)	2GNG	K19232	3710002383505	YPK	X			X			
HARROW DISK (11FT)	NONE		3710005333753		X			X			
SPRAYER (ROTO)	NONE		3740001662910		X			X			
SPRAYER INSECTICIDE	NONE	S11847	3740009010720		X			X			
SPRAYER INSECTICIDE	NONE	U11573	3740010260511		X			X			
SPRAYER PESTICIDE	NONE		3740010274817		X			X			
SWEEPER TURF	SKID MTD		3750004020871		X			X			
SWEEPER TURF SELFDUMP	TWD PTO	U76381	3750009580117		X			X			
DITCHING MACHINE	NONE	G29928	3805003498941	E23	X			X	X		
DITCHING MACHINE	4262	G29945	3805007276719	ETC	X			X	X		
COMPACTOR (HS)	K300	NO-LIN	3805010244064	EXB	X			X	X		
DITCHING MACHINE	2-24 INCHES	NO-LIN	3805010794752	***	X			X	X		

Figure E-2. Identification of required forms for combat/tactical vehicles and support equipment—Continued

ECC NOUN	MODEL	LIN	NSN	EIC	REG # REQ	2408-4 WPNS REC	2408-5 MWO	2408-9 A/T/L/G	2408-9 USAGE	DD2026 USAGE	2408-9 OVHL
ROCK PICKER (TOWED)	NONE	R03338	3805010917617	EGC	X			X			
DITCHING MACHINE	CRLR/WHL MTD		3805011095949		X			X			
DITCHING MACHINE	NONE	D30013	3805011794264	E2V	X			X	X		
COMPACTOR	815F	E61618	3805014318439	E5E	X			X	X		
SWEEPER (GAS-TOWED)	KGV 3830	U76871	3825000875019	EU6	X			X			
SWEEPER (SP/TRCT MTD)	MS1266A	U76734	3825005401437	EU7	X			X			
CLEANER VACUUM (SP)	6-8CU YD	E33626	3825005910099	E3Q	X			X			
CLNR VACUUM(TRLR MTD)	12HP	E33661	3825005930066	X	X			X			
SWEEPER MAGNETIC (SP)	JD401B	U76734	3825005980045	EU9	X			X			
SWEEPER (GAS/DSL TWD)	MP38-67	U76871	3825008325269	EVB	X			X			
SWEEPER (GAS/DSL TWD)	ES-100K	U76871	3825010227329	EVD	X			X			
SWEEPER ROTARY (SP)	NONE	U76754	3825010907913	E25	X			X			
SWEEPER ROTARY (SP)	NONE	U76744	3825010907914	E26	X			X			
SWEEPER ROTARY (SP)	2933-AH	U76754	3825010932394	E27	X			X			
SWEEPER ROTARY (SP)	NONE	S76994	3825010958319	E28	X			X			
SWEEPER ROTARY (SP)	NONE	S76984	3825011075730	E3A	X			X			
SWEEPER ROTARY (TWD)	P17B	S77004	3825012831135	X	X			X			
SWEEPER (DSL-TOWED)	MB 53MH	U76871	3825013142926	EVH	X			X			
MACH LAND CLEARING	DED4X4	L92650	3830011128362	E35	X			X			
HAMMER P/D (SELP PWD)	180M	K04697	3895000140583	E9G	X			X			
COMPACTOR (TRCTR MTD)	NONE	E61041	3895006116254	E37	X			X			
CABLE LAYER UNGND	LC-236/M	C66801	3895009734512	HJF	X			X			
RPR TRLR PWR UT (TWD)	NONE	R76576	3895010374942	X	X			X			
TAMPER VIBR	INTE	V11001	3895013836488	E48	X			X			
CLNR SEWER (TRK MTD)	PC-50-10	E32569	4940010042787	FTN	X			X			
AGR MACH P/SEWER CLNR	736CONCO	B01866	4940010042789	X	X			X			
CLNR STEAM (TRLR MTD)	NONE	C32887	4940010259856	2BC	X			X			
CLNR SEWER (TRK MTD)	NONE	C32450	4940011648172	FTK	X			X			
CLNR SEWER (TRLR MTD)	NONE	C48676	4940012355441	X	X			X			
TOOL SET PIONR PTBL	3240	W58486	5180002899569	YXC	X			X			
TANK ASPHALT STORAGE	TAS5B	V12312	5430009339055	EXR	X			X			

**P MATERIAL HANDLING EQUIPMENT**

**Figure E-2. Identification of required forms for combat/tactical vehicles and support equipment—Continued**

ECC NOUN	MODEL	LIN	NSN	EIC	REG # REQ	2408-4 WPNS REC	2408-5 MWO	2408-9 A/T/L/G	2408-9 USAGE	DD2026 USAGE	2408-9 OVHL
<b>PA CRANES, WAREHOUSE</b>											
CRANE (TRK WHSE-GAS)	10FM	F39104	3950001974935	DML	X			X			
CRANE (TRK WHSE-GAS)	NC-10	F39104	3950002711837	DPW	X			X			
CRANE (TRK WHSE-ELEC)	42SF6778	F38967	3950002711846	DDM	X			X			
CRANE (TRK WHSE-ELEC)	MHE80	F38967	3950002711847	DC4	X			X			
CRANE (TRK WHSE-ELEC)	CX4EE	F38967	3950004026705	DDN	X			X			
CRANE (TRK WHSE-GED)	WHSE	F39126	3950005907816	DPY	X			X			
CRANE (TRK WHSE-GAS)	29690	F39104	3950007233294	DMJ	X			X			
CRANE (TRK WHSE-GAS)	10F46717	F39104	3950007233295	DMK	X			X			
CRANE (TRK WHSE-DSL)	AP308DED	F39104	3950012230298	DMM	X			X			
CRANE (TRK WHSE)	NONE		3950014125345	DXL	X			X			
<b>PB TRUCKS, FORKLIFT, ELECTRIC</b>											
TRK FORKLIFT (ELEC)	FTHY4048	KK0367	3930000539216		X			X	X		
TRK FORKLIFT (ELEC)	FTHY4048	X50284	3930000568209	DAA	X		X	X	X		
TRK FORKLIFT (ELEC)	040M02	X50489	3930000645871	DBE	X		X	X	X		
TRK FORKLIFT (ELEC)	FLF100	X51037	3930000699040	DB6	X			X	X		
TRK FORKLIFT (ELEC)	FTD-060-002		3930000770542	DAW	X			X	X		
TRK FORKLIFT (ELEC)	337450	X50489	3930000866677	DBG	X		X	X	X		
TRK FORKLIFT (ELEC)	FE20-24	X49188	3930001514432	DAB	X		X	X	X		
TRK FORKLIFT (ELEC)	F52T10	X51037	3930001728714	DB7	X			X	X		
TRK FORKLIFT (ELEC)	SR30MIL	X45283	3930002114323	DBD	X		X	X	X		
TRK FORKLIFT (ELEC)	FTD040EE	X50489	3930002366253	DAC	X			X	X		
TRK FORKLIFT (ELEC)	ECE2024	X49188	3930002711899	DBP	X			X	X		
TRK FORKLIFT (ELEC)	ECE2024S	X49188	3930002711902	X	X			X	X		
TRK FL (PLT-PWR/ELEC)	NONE	X54658	3930002711903	DAD	X		X	X	X		
TRK FORKLIFT (ELEC)	FTHEG40	X50489	3930002729972	DBS	X			X	X		
TRK FORKLIFT (ELEC)	FSEG20148	X49188	3930002738218	DBU	X			X	X		
TRK FORKLIFT (ELEC)	FSHYG-20/48	X49188	3930002738220	DBW	X			X	X		
TRK FORKLIFT (ELEC)	FSHG2048	X49188	3930002738221	DBX	X			X	X		
TRK FORKLIFT (ELEC)	AUTO BF40	X50489	3930002738229	DBY	X			X	X		

**Figure E-2. Identification of required forms for combat/tactical vehicles and support equipment—Continued**

ECC NOUN	MODEL	LIN	NSN	EIC	REG # REQ	2408-4 WPNS REC	2408-5 MWO	2408-9 A/T/L/G	2408-9 USAGE	DD2026 USAGE	2408-9 OVHL
TRK FORKLIFT (ELEC)	AEE180	X50489	3930003271600	DAE	X		X	X	X		
TRK FORKLIFT (ELEC)	AEE144	X50436	3930003271603	DAF	X		X	X	X		
TRK FORKLIFT (ELEC)	EE5600M	X50436	3930003476175	DC8	X		X	X	X		
TRK FORKLIFT (ELEC)	FL40EE6550	X50284	3930004035661	DAH	X		X	X	X		
TRK FORKLIFT (ELEC)	FL40EE6250	X50489	3930004035662	DAJ	X		X	X	X		
TRK FORKLIFT (ELEC)	AUTOMATIC	X45283	3930004740546	DA9	X		X	X	X		
TRK FORKLIFT (ELEC)	FE60-24	X50900	3930004798769	DAK	X		X	X	X		
TRK FORKLIFT (ELEC)	FTD040EE	X50284	3930004948151	DAL	X		X	X	X		
TRK FORKLIFT (ELEC)	ELCTSTDR	X49198	3930005017242		X		X				
TRK FORKLIFT (ELEC)	E-3RT-57	X45283	3930005556290	DBA	X		X	X	X		
TRK FORKLIFT (ELEC)	FTD040EE	X50489	3930007096341	DAM	X		X	X	X		
TRK FORKLIFT (ELEC)	FTD040EE	X50284	3930007096342	DAN	X		X	X	X		
TRK FORKLIFT (ELEC)	BAK040EE	X50489	3930007096358	DDC	X		X	X	X		
TRK FORKLIFT (ELEC)	6M 040EE	X50832	3930007244057	DA2	X		X	X	X		
TRK FORKLIFT (ELEC)	FTD020EE	X49188	3930007244058	DAP	X		X	X	X		
TRK FORKLIFT (ELEC)	060EE	X50969	3930007244059	DAT	X		X	X	X		
TRK FORKLIFT (ELEC)	E-FL100	X51037	3930007386030	DB8	X		X	X	X		
TRK FORKLIFT (ELEC)	E-FL100	X51037	3930008975270	DB9	X		X	X	X		
TRK FORKLIFT (ELEC)	020EESS	X49188	3930009357864	DAQ	X		X	X	X		
TRK FORKLIFT (ELEC)	GO-EE5600	X50900	3930009357867	DDA	X		X	X	X		
TRK FORKLIFT (ELEC)	020EE 2	X49188	3930009650075	DAR	X		X	X	X		
TRK FORKLIFT (ELEC)	ACE100CR	X51037	3930010319379	DAS	X		X	X	X		
TRK FORKLIFT (ELEC)	AC SR30B	X45283	3930010498700	DDE	X		X	X	X		
TRK FORKLIFT (ELEC)	E40BMIL	X50436	3930010559721	DAU	X		X	X	X		
TRK FORKLIFT (ELEC)	SL-42.5	T73474	3930010803246	DAV	X		X	X	X		
TRK FORKLIFT (ELEC)	SHREK	X45283	3930010878698	DDF	X		X	X	X		
TRK FL (PLT-PWR/ELEC)	MP40EE	X54668	3930010891429	DAX	X		X	X	X		
TRK FORKLIFT (ELEC)	NONE	T50968	3930010915384	DCR	X		X	X	X		
TRK FORKLIFT (ELEC)	SL-4413	T73474	3930011231300	DAY	X		X	X	X		
TRK FORKLIFT (ELEC)	ACE 40	X50436	3930011267505	DAZ	X		X	X	X		
TRK FORKLIFT (ELEC)	6000 LBS	T51071	3930011393721	DDG	X		X	X	X		
TRK FORKLIFT (ELEC)	SL443ESS	T73474	3930012084600	DDH	X		X	X	X		
TRK FORKLIFT (ELEC)	MCCATM25	X49188	3930012126675	DDJ	X		X	X	X		

Figure E-2. Identification of required forms for combat/tactical vehicles and support equipment—Continued

ECC NOUN	MODEL	LIN	NSN	EIC	REG # REQ	2408-4 WPNS REC	2408-5 MWO	2408-9 A/T/L/G	2408-9 USAGE	DD2026 USAGE	2408-9 OVHL
TRK FORKLIFT (ELEC)	60HEV	X50900	3930012238436	DDB	X		X	X	X		
TRK FORKLIFT (ELEC)	E40EV36V	X50489	3930012238437	DDD	X		X	X	X		
TRK FORKLIFT (ELECT)	E25XLMIL	X49188	3930013441088	DDQ	X		X	X	X		
TRUCK FORKLIFT	988F5ER	T49009	3930014493178		X		X	X			
TRK FORKLIFT (ELEC)	EFG26002	X50436	3930121871464	DDK	X		X	X	X		
TRK FORKLIFT (ELEC)	EFG36004	X50832	3930121871465	DDL	X		X	X	X		
<b>PC TRUCKS, FORKLIFT, GED</b>											
TRK FORKLIFT (GAS)	C403	X51654	3930000179079	DM7	X		X	X	X		
TRK FORKLIFT (GAS)	LT-60RS	X51791	3930000251015	DN4	X		X	X	X		
TRK FORKLIFT (GAS)	RT-100-RS	X52750	3930000384411	DNT	X		X	X	X		
TRK FORKLIFT (GAS)	NONE	KK0539	3930000539185		X		X	X	X		
TRK FORKLIFT (GAS)	MY-40MB	X51380	3930000645868	DLA	X		X	X	X		
TRK FORKLIFT (GAS)	MY-60-MC	X51791	3930000645869	DN5	X		X	X	X		
TRK FORKLIFT (GAS)	MY60MCRS	X51791	3930000645870	DN6	X		X	X	X		
TRK FORKLIFT (GAS)	FJF-040	X51380	3930000738676	DLB	X		X	X	X		
TRK FORKLIFT (GAS)	502PG	X51380	3930000739222	DLC	X		X	X	X		
TRK FORKLIFT (GAS)	NONE	X51380	3930000894448		X		X	X	X		
TRK FORKLIFT (GAS)	FJF040	X51380	3930001514428	DLD	X		X	X	X		
TRK FORKLIFT (GAS)	HYSH150F	X52750	3930001514434	DLE	X		X	X	X		
TRK FORKLIFT (GAS)	F40-24PS	X51517	3930001654102	DLF	X		X	X	X		
TRK FORKLIFT (GAS)	CL 108IN	X51517	3930002248685	DNB	X		X	X	X		
TRK FORKLIFT (GAS)	MHE210	X51791	3930002354674	DLG	X		X	X	X		
TRK FORKLIFT (GAS)	MDL 40	X51380	3930002574868	DM8	X		X	X	X		
TRK FORKLIFT (GAS)	MDL 4024		3930002668957	DN7	X		X	X	X		
TRK FORKLIFT (GAS)	CL-4024	X51517	3930002668959	DNC	X		X	X	X		
TRK FORKLIFT (GAS)	60 RS		3930002668963	DN9	X		X	X	X		
TRK FORKLIFT (GAS)	RS-53	X51106	3930002711449	DNG	X		X	X	X		
TRK FORKLIFT (GAS)	DP6024	X51791	3930002711892	DPA	X		X	X	X		
TRK FORKLIFT (GAS)	RT-150-RS	X52750	3930002711893	DN2	X		X	X	X		
TRK FORKLIFT (GAS)	LT-60	X51791	3930002729289	DN3	X		X	X	X		
TRK FORKLIFT (GAS)	LT 60-RS	X51791	3930002729290	DPB	X		X	X	X		

Figure E-2. Identification of required forms for combat/tactical vehicles and support equipment—Continued

ECC NOUN	MODEL	LIN	NSN	EIC	REG # REQ	2408-4 WPNS REC	2408-5 MWO	2408-9 A/T/L/G	2408-9 USAGE	DD2026 USAGE	2408-9 OVHL
TRK FORKLIFT (GAS)	6024 RS52	X51791	3930002738207	DPC	X		X	X	X		
TRK FORKLIFT (GAS)	KG51T20	X51106	3930002738223	DNM	X		X	X	X		
TRK FORKLIFT (GAS)	LT-48	X51654	3930002738224	DQC	X		X	X	X		
TRK FORKLIFT (GAS)	KG51T20	X51106	3930002738226	DNL	X		X	X	X		
TRK FORKLIFT (GAS)	LT-56-RS	X52339	3930002921098	DBZ	X		X	X	X		
TRK FORKLIFT (GAS)	LT-56-RS	X52202	3930002921100	DM2	X		X	X	X		
TRK FORKLIFT (GAS)	C500-20	X51106	3930003159699	DLH	X		X	X	X		
TRK FORKLIFT (GAS)	YL-100-RS	X52750	3930003519946	DNX	X		X	X	X		
TRK FORKLIFT (GAS)	PG40-24	X51585	3930004195738	DLJ	X		X	X	X		
TRK FORKLIFT (GAS)	1756420	X51243	3930004361411	DLK	X		X	X	X		
TRK FORKLIFT (GAS)	1756421	X51106	3930004361413	DLL	X		X	X	X		
TRK FORKLIFT (GAS)	F40-24PS	X51654	3930004595948	DLM	X		X	X	X		
TRK FORKLIFT (GAS)	6024P5	X52407	3930004890263	DLN	X		X	X	X		
TRK FORKLIFT (GAS)	CL 4024	X51517	3930005422175	DNE	X		X	X	X		
TRK FORKLIFT (GAS)	540-RS	X52202	3930005542318	DM3	X		X	X	X		
TRK FORKLIFT (GAS)	40FS180	X51654	3930005564955	DLP	X		X	X	X		
TRK FORKLIFT (GAS)	NONE		3930005616603	DPG	X		X	X	X		
TRK FORKLIFT (GAS)	NONE	X51071	3930005616643	DPH	X		X	X	X		
TRK FORKLIFT (GAS)	NONE	X51257	3930005616655	DPJ	X		X	X	X		
TRK FORKLIFT (GAS)	4500 LBS	X51671	3930005616654	DPK	X		X	X	X		
TRK FORKLIFT (GAS)	NONE	X52797	3930005616693	DPL	X		X	X	X		
TRK FORKLIFT (GAS)	NONE	X52681	3930005616739		X		X	X	X		
TRK FORKLIFT (GAS)	NONE	X51299	3930005616740	DPM	X		X	X	X		
TRK FORKLIFT (GAS)	NONE	X51722	3930005616747	DPN	X		X	X	X		
TRK FORKLIFT (GAS)	40PS100	X51517	3930005907814	DLQ	X		X	X	X		
TRK FL (GAS-DIESEL)	CY150	X52750	3930006217413	DNS	X		X	X	X		
TRK FORKLIFT (GAS)	TYPE E		3930006782580		X		X	X	X		
TRK FORKLIFT (GAS)	G5P44024	X51380	3930006789913	DM9	X		X	X	X		
TRK FORKLIFT (GAS)	461-RS SRT	X51654	3930006789916	DQD	X		X	X	X		
TRK FORKLIFT (GAS)	461	X51517	3930006789917	DNF	X		X	X	X		
TRK FORKLIFT (GAS)	GLF-100		3930006794457	DPP	X		X	X	X		
TRK FORKLIFT (GAS)	MONO-2	X51380	3930007243568	DNA	X		X	X	X		
TRK FORKLIFT (GAS)	MONO-2		3930007243569	DPD	X		X	X	X		

Figure E-2. Identification of required forms for combat/tactical vehicles and support equipment—Continued

ECC NOUN	MODEL	LIN	NSN	EIC	REG # REQ	2408-4 WPNS REC	2408-5 MWO	2408-9 A/T/L/G	2408-9 USAGE	DD2026 USAGE	2408-9 OVHL
TRK FORKLIFT (GAS)	MONO-2	X51380	3930007243570	DLR	X		X	X	X		
TRK FORKLIFT (GAS)	FJF060	X51791	3930007385938	DLS	X		X	X	X		
TRK FORKLIFT (GAS)	TC-200	X52784	3930007403109	DLT	X		X	X	X		
TRK FORKLIFT (GAS)	462SG	X51654	3930007813855	DM4	X		X	X	X		
TRK FORKLIFT (GAS)	462SG40	X51517	3930007813856	DND	X		X	X	X		
TRK FORKLIFT (GAS)	CLARK	X51243	3930007813857	DNN	X		X	X	X		
TRK FORKLIFT (GAS)	C20B16	X51106	3930007813858	DLU	X		X	X	X		
TRK FL (GAS/DIESEL)	H150C	X52750	3930008974632	DLV	X		X	X	X		
TRK FORKLIFT (GAS)	KGPA51	X51791	3930008974633	DPE	X		X	X	X		
TRK FORKLIFT (GAS)	502PG	X51311	3930009263807	DLW	X		X	X	X		
TRK FORKLIFT (GAS)	F60128IN	X52202	3930009357855	DLX	X		X	X	X		
TRK FORKLIFT (GAS)	F60100IN	X52065	3930009357856	DLY	X		X	X	X		
TRK FORKLIFT (GAS)	F60-24PS	X52339	3930009357857	DLZ	X		X	X	X		
TRK FORKLIFT (GAS)	S40-PC	X51654	3930009357865	DL2	X		X	X	X		
TRK FORKLIFT (GAS)	S40CP100	X51517	3930009357866	DL3	X		X	X	X		
TRK FORKLIFT (GAS)	FJF040	X51380	3930009357963	DL4	X		X	X	X		
TRK FORKLIFT (GAS)	FP6024PS	X51791	3930009357979	DL5	X		X	X	X		
TRK FORKLIFT (GAS)	1615159R	X51654	3930009541303	DM5	X		X	X	X		
TRK FORKLIFT (GAS)	C40B	X51517	3930009549311	DL6	X		X	X	X		
TRK FORKLIFT (GAS)	FT2024PS	X51243	3930009583682	DL7	X		X	X	X		
TRK FORKLIFT (GAS)	FT2024PS	X51106	3930009583683	DL8	X		X	X	X		
TRK FORKLIFT (GAS)	FP6024PS	X51791	3930009583684	DL9	X		X	X	X		
TRK FORKLIFT (GAS)	C40PS144	X51517	3930010398291	DMA	X		X	X	X		
TRK FORKLIFT (GAS)	40CPS180	X51654	3930010398292	DMB	X		X	X	X		
TRK FORKLIFT (GAS)	P40PS144	X51585	3930010404594	DMC	X		X	X	X		
TRK FORKLIFT (GAS)	P60PS180	X51791	3930010525050	DMD	X		X	X	X		
TRK FORKLIFT (GAS)	ACC10PS	X52613	3930010543832	DME	X		X	X	X		
TRK FORKLIFT (GAS)	C45PS144	X51517	3930010754937	DMF	X		X	X	X		
TRK FORKLIFT (GAS)	C500Y45	X51585	3930010853767	DMG	X		X	X	X		
TRK FORKLIFT (GAS)	FG30N(T)	X51585	3930011463990	DMH	X		X	X	X		
TRK FORKLIFT (CBD)	H40XLMIL	T73645	3930011727891	DXA	X		X	X	X		
TRK FORKLIFT (CBD)	H60XLMIL	T49096	3930011727892	DXG	X		X	X	X		
TRK FL (GAS/DIESEL)	DSL SRT	X51654	3930013845310	DXK	X		X	X	X		

Figure E-2. Identification of required forms for combat/tactical vehicles and support equipment—Continued



ECC NOUN	MODEL	LIN	NSN	EIC	REG # REQ	2408-4 WPNS REC	2408-5 MWO	2408-9 A/T/L/G	2408-9 USAGE	DD2026 USAGE	2408-9 OVHL
<b>PE TRACTORS, WAREHOUSE</b>											
TRCTR WHSE (WHL-GAS)	J-217-F	W89557	3930000383166	DMN	X		X	X	X		
TRCTR WHSE (WHL-GAS)	MT-40MA	W89557	3930000646563	DMP	X		X	X	X		
TRCTR WHSE (WHL-ELEC)	540-10	W89146	3930000900868	DA5	X		X	X	X		
TRCTR WHSE (WHL-GAS)	G/PC	W89557	3930001813217	DMQ	X		X	X	X		
TRCTR WHSE (WHL-ELEC)	A BT-N	W89146	3930002309952	DA6	X		X	X	X		
TRCTR WHSE (WHL ELEC)	CRESENT MW	W89283	3930002656853	DA4	X		X	X	X		
TRCTR WHSE (WHL-GAS)	A-452-54	W89557	3930002656864	DMR	X		X	X	X		
TRCTR WHSE (WHL-GAS)	CTA40	W89557	3930003476173	DMX	X		X	X	X		
TRCTR WHSE (WHL-ELEC)	JN-2-SE	W89146	3930003519918	DA7	X		X	X			
TRCTR WHSE (WHL ELEC)	MW-4SE	W89420	3930003519919	DA8	X		X	X	X		
TRCTR WHSE (WHL-GAS)	ACT-40	W89557	3930006789914	DMS	X		X	X	X		
TRCTR WHSE (WHL-GAS)	T-40	W89557	3930006794823	DMT	X		X	X	X		
TRCTR WHSE (WHL-GAS)	MT-40	W89557	3930007243471	DMU	X		X	X	X		
TRCTR WHSE (WHL-GAS)	G-40	W89557	3930007248146	DMY	X		X	X	X		
TRCTR WHSE (WHL-GAS)	JG-40PT	W89557	3930009261066	DMV	X		X	X	X		
TRCTR WHSE (WHL-GAS)	NONE	W89557	3930009534890	DMW	X		X	X	X		
TRCTR WHSE (WHL-GAS)	JG40	W89557	3930010478722	DP5	X		X	X	X		
TRCTR WHSE (WHL-GAS)	SM340	W89557	3930010752812	DP6	X		X	X	X		
TRCTR WHSE (WHL ELEC)	SRT	NO-LIN	3930010949017	DCT	X		X	X	X		
TRCTR WHSE (DED PT)	NONE	W89557	3930013822567	DXJ	X		X	X	X		
<b>PF TRUCKS, STADDLE</b>											
TRK STDL E-CARRY-GAS	C M300H	X56997	3930000520034	DMZ	X		X	X	X		
<b>PG TRUCKS, FORKLIFT-ROUGH TERRAIN</b>											
TRK FORKLIFT (DSL)	MLT6-2	X48914	3930003271575	DJB	X		X	X	X		
TRK FORKLIFT (DSL)	ARTFT6	X48914	3930004195744	DJC	X		X	X	X		
TRK FORKLIFT (DSL)	RTL 101S	X49051	3930004655869	DJD	X		X	X	X		
TRK FORKLIFT (GAS)	MR 100RS	X52476	3930005542700	DJZ	X		X	X	X		
TRK FORKLIFT (GAS)	100-RS#2	X52476	3930006789056	DJ2	X		X	X	X		

Figure E-2. Identification of required forms for combat/tactical vehicles and support equipment—Continued

ECC NOUN	MODEL	LIN	NSN	EIC	REG # REQ	2408-4 WPNS REC	2408-5 MWO	2408-9 A/T/L/G	2408-9 USAGE	DD2026 USAGE	2408-9 OVHL
TRK FORKLIFT (GAS)	RJF060	X51928	3930006794458	DJX	X		X	X	X		
TRK FORKLIFT (GAS)	HR-100	X52476	3930007999956	DJ3	X		X	X	X		
TRK FORKLIFT	NONE	X52810	3930008327043	DJG	X		X	X	X		
TRK FORKLIFT (DSL)	A-3520	X49051	3930009030899	DJH	X		X	X	X		
TRK FORKLIFT (DSL)	MLT-6	X48914	3930009030900	DJJ	X		X	X	X		
TRK FORKLIFT (DSL)	MLT-6W	X48914	3930009263835	DJK	X		X	X	X		
TRK FORKLIFT (DSL)	MLT-6CH	X48914	3930009370220	DJL	X		X	X	X		
TRK FORKLIFT (GAS)	390012	X52476	3930009730659	DJY	X		X	X	X		
TRK FORKLIFT (DSL)	10 ROPS	X49051	3930010528997	DJP	X		X	X	X		
TRK FORKLIFT (DSL)	MLT6CH	X48914	3930010534823	DJQ	X		X	X	X		
TRK FORKLIFT (DSL)	10-1ROPS	X49051	3930010534824	DJR	X		X	X	X		
TRK FORKLIFT (DSL)	ARTFT6	X48914	3930010543830	DJS	X		X	X	X		
TRK FORKLIFT (DSL)	MLT6ROPS	X48914	3930010543831	DJT	X		X	X	X		
TRK FORKLIFT (DSL)	IHC-10A	T49119	3930010543833	DJU	X		X	X	X		
TRK FORKLIFT (DSL)	MDL M4K	T49255	3930010764237	DJV	X		X	X	X		
TRK FORKLIFT (DED)	DV43	T48941	3930010823758	DJN	X		X	X	X		
TRK FORKLIFT (DED)	NONE	T48944	3930011580849	DJW	X		X	X	X		
TRK FORKLIFT (GAS)	QUALPLUS	X52750	3930011957638	DP7	X		X	X			
TRK FL (ADVERSE TERR)	544E	T49266	3930013018250	DJ7	X		X	X	X		
TRK FORKLIFT (DSL)	M413	T49255	3930013308906	DJ5	X		X	X	X		
TRK FORKLIFT (DSL)	M413	T49255	3930013308907	DJ6	X		X	X	X		
<b>PI TRUCKS, FORKLIFT-OTHER, DED</b>											
TRK FL (GAS-DIESEL)	RT-100	X52750	3930000384410	DNZ	X		X	X	X		
TRK FORKLIFT (DED)	H5208	X48904	3930005030340	DXB	X		X	X	X		
TRK FL (GAS-DIESEL)	NONE	X52750	3930013733625	DQF	X		X	X			
TRUCK FORKLIFT	6000 LBS	T51036	3930013787497	DXM	X		X	X	X		
TRK FORKLIFT (DED)	NONE	T48972	3930121822667		X		X	X			
<b>PJ TRUCKS, STOCK SELECTOR</b>											
TRUCK STOCK SELECTOR	130S307	X56928	3930001863482	DCA	X		X	X	X		
TRUCK STOCK SELECTOR	SS104210	X56928	3930010156526	DCC	X		X	X	X		

Figure E-2. Identification of required forms for combat/tactical vehicles and support equipment—Continued

ECC NOUN	MODEL	LIN	NSN	EIC	REG # REQ	2408-4 WPNS REC	2408-5 MWO	2408-9 A/T/L/G	2408-9 USAGE	DD2026 USAGE	2408-9 OVHL
<b>PK TRUCKS, CRANES, 140 TON OR OVER</b>											
CRANE (TRK MTD)	250 TON	C38942	3810010279253	DSE	X		X	X	X		
CRANE (TRK MTD) 140T	NONE	C38874	3810010279254	DSA	X		X	X	X		
CRANE (TRK MTD) 140T	HC238A	C38874	3950011109224	DSF	X		X	X			
<b>PL TRUCKS, FORKLIFT, OTHER</b>											
TRK FORKLIFT (ELEC)	RSEAT-3	X45283	3930005997512	DBB	X		X	X	X		
CRANE (TRK MTD)	SKN4390	F35816	3930007890897	DJE	X		X	X	X		
CRANE (TRK MTD)	SKN4390 174	F35816	3930007999957	DJF	X		X	X	X		
TRK LIFT PLTFROM (E)	PCH-12E	X53161	3930009730301	DAG	X		X	X	X		
TRK FL PLTFM	HYD LIFT	T45231	3930011198738	FMA	X		X	X	X		
TRK FORKLIFT	10000 LBS	T49266	3930012985737	DXH	X		X	X	X		
TRK LFT CN HANDLER	V900CH	T53548	3930013880994	***	X		X	X	X		
TRUCK, FORKLIFT	NONE	T49164	3930014062519		X		X	X			
TRUCK, FORKLIFT	NONE	T73347	3930014172886	DJ8	X		X	X	X		
TRK FORKLIFT	NONE		3930014614165		X		X	X			
<b>PO CONVEYORS</b>											
CONVEYOR BELT (GAS)	PH 70	F06698	3910008179170	EZS	X			X			
<b>PQ RAMP DOCKS</b>											
RAMP LD VEH (WHL MTD)	DS169636	R11154	3990010261575	DVG			X	X			
RAMP LD VEH (WHL MTD)	ASYR1692	R11154	3990010590104	DVE			X	X			
RAMP LD VEH (WHL MTD)	1692366F	R11154	3990011217758	DVF			X	X			
<b>PR TRAILERS</b>											
TRAILER CABLE REEL	NONE		2330005403732		X		X	X			
<b>PS TRUCKS, MATERIAL HANDLING</b>											
TRUCK RIDING (ELEC)	NONE	D13522	3930010263213		X		X	X			

Figure E-2. Identification of required forms for combat/tactical vehicles and support equipment—Continued

ECC NOUN	MODEL	LIN	NSN	EIC	REG # REQ	2408-4 WPNS REC	2408-5 MWO	2408-9 A/T/L/G	2408-9 USAGE	DD2026 USAGE	2408-9 OVHL
<b>PY MISCELLANEOUS SUPPORT EQUIPMENT</b>											
TRCTR WHL ACFT (TOW)	NONE	T89053	1730011174118	UAF	X		X	X			
TRCTR WHLD ACFT	690-181	W88803	1740001341053	UAQ	X		X	X			
TEST STAND HYD (GAS)	PN 7454	W00221	4920001445581	TA5	X		X	X			
STD MAINT ACFT PU	PN45977	U25029	4920001769236	UAM	X		X	X			
TEST STAND HYD (GAS)	PNTE6759	W00221	4920008325491	TCG	X		X	X			
TEST STAND HYD (GAS)	PN674016	W00221	4920008826401	TCJ	X		X	X			
TEST STAND HYD (ELEC)	MDL 7600	W00084	4920010700871	TBW	X		X	X			
SVC PLTFM (SP)	NONE	S79882	4940011050766	FSB	X		X	X			
SVC PLTFM (SP)	NONE	S79882	4940011050767	FSA	X		X	X			
<b>Q SUPPORT EQUIPMENT</b>											
<b>EY MISCELLANEOUS SUPPORT EQUIPMENT</b>											
SMOKE GENERATOR	M3A3	J30492	1040005873618	5CA				X	X		
SMOKE GENERATOR	M3A4	J30492	1040011439506	5CB				X	X		
SMOKE GENERATOR	M56	G58151	1040013801400	5CF				X			
SMOKE GENERATOR	M58	G87229	1040014138932	5CG	X			X	X		
<b>GQ COMPRESSORS</b>											
CARR CMD POST FT	(C2V)M4	C11870	2350013689528	AP4	X			X	X	X	X
<b>QA BAKERY</b>											
BAKERY OVEN(TRLR MTD)	MO-311	B18373	7310002155260	YBD	X			X			
BAKERY OVEN(TRLR MTD)	M-1945	B18373	7310002558068	YBF	X			X			
BAKERY OVEN(TRLR MTD)	533-235	B18373	7310009035402	YBI	X			X			
DOUGH OTFT (TRLR MTD)	M534-1A	G40261	7320003345336	YBH	X			X			
DOUGH OTFT (TRLR MTD)	TM-BP68	G40261	7320008808745	YB5	X			X			
<b>QB GENERATORS</b>											

Figure E-2. Identification of required forms for combat/tactical vehicles and support equipment—Continued

ECC NOUN	MODEL	LIN	NSN	EIC	REG # REQ	2408-4 WPNS REC	2408-5 MWO	2408-9 A/T/L/G	2408-9 USAGE	DD2026 USAGE	2408-9 OVHL
GENERATOR, 125KW	NONE	NO-LIN	3820014375703	***	X			X	X		
GEN ST (DSL-TRLR MTD)	PU-614/M	J51418	6115000162356		X			X			
GEN ST (DSL-TRLR MTD)	PU-751/M	G37273	6115000331373	VJW	X			X	X		
GEN ST (DSL-TRLR MTD)	PU-753/M	G40744	6115000331389	VJB	X			X	X		
GEN ST (GAS-TRLR MTD)	PU-304C	J41452	6115000568421	VLC	X			X	X		
GEN ST (GAS-TRLR MTD)	PU-631/G	P47832	6115000595172	VJX	X			X	X		
GEN ST (GAS-WHL MTD)	JHGV7.5A	J49055	6115000746396	VKA	X			X	X		
GEN ST (DSL-SKID MTD)	MIL26727	J38547	6115000812030	VCB	X			X	X		
GEN ST (GAS-TRLR MTD)	PU-628/G	J46258	6115000870873	VGB	X			X			
GEN ST (GAS-TRLR MTD)	PU-626/G	J46255	6115000870972	VGQ	X			X	X		
GEN ST (DSL-WHL MTD)	SP-HF15	J36040	6115000895099	VLE	X			X	X		
GEN SET(DSL-SKID MTD)	MEP113A	J36006	6115001181244	VLG				X	X		
GEN ST (DSL-TRK MTD)	PU-700/M	J35629	6115001257876	VEE	X			X	X		
GEN ST (DSL-TRK MTD)	PU-699/M	J35595	6115001320488	VEF	X			X	X		
GEN ST	MEP007A	J38712	6115001339101	VCG				X	X		
GEN ST (DSL-TRLR MTD)	PU650A/G	J35629	6115002203878	VFA	X			X	X		
GEN ST (DSL-TRLR MTD)	PU650B/G	J35629	6115002581622	VEM	X			X	X		
GEN ST (DSL-TRK MTD)	PU699A/M	J35595	6115002581655	VFB	X			X	X		
GEN ST (DSL-TRLR MTD)	PU-732/M	G36074	6115002605082	VLL	X			X	X		
GEN ST (DSL-TRK MTD)	PU700A/M	J35629	6115002839051	VFC	X			X	X		
GEN ST (GAS-TRLR MTD)	PU-248/U	J40904	6115003560995	VC4	X			X	X		
GEN ST (DSL-TRLR MTD)	PU707A/M	J35680	6115003949573	VLM	X			X	X		
GEN ST (DSL-TRLR MTD)	PU406B/M	J36383	6115003949576	VCM	X			X	X		
GEN ST (DSL-TRLR MTD)	PU405A/M	J35492	6115003949577	VCN	X			X	X		
GEN ST (DSL-TRLR MTD)	PU-760/M	G53871	6115003949581	VLN	X			X	X		
GEN ST (DSL-TRLR MTD)	PU707/M2	J35680	6115004644195	VMB	X			X	X		
GEN ST (GAS-TRLR MTD)	PU-666/G	J46265	6115004859207	VHC	X			X	X		
GEN ST (GAS-TRLR MTD)	PU-322/G		6115005773370	VC7	X			X	X		
GEN ST (GAS-TRLR MTD)	PU-332/U	J41786	6115005778471	VJH	X			X	X		
GEN ST (GAS ENGINE)	CE55ACWVK6	NO-LIN	6115006281243	VJQ	X			X			
GEN ST (GAS-TRLR MTD)	PU294/G6	J41315	6115006355614	VC9	X			X	X		
GEN ST (GAS-TRLR MTD)	PU290/MR	J41178	6115006359883	VDB	X			X	X		
GEN ST (GAS-TRLR MTD)	PU-304	J41452	6115006434674	VMF	X			X	X		

Figure E-2. Identification of required forms for combat/tactical vehicles and support equipment—Continued

ECC NOUN	MODEL	LIN	NSN	EIC	REG # REQ	2408-4 WPNS REC	2408-5 MWO	2408-9 A/T/L/G	2408-9 USAGE	DD2026 USAGE	2408-9 OVHL
GEN ST (DSL-TRLR MTD)	PU-407/M	J35561	6115007023347	VES	X			X	X		
GEN ST (GAS-TRLR MTD)	PU-409/M	J41897	6115007023348	VJJ	X			X	X		
GEN ST (DSL-TRK MTD)	PU-408/M	J35698	6115007090469		X			X			
GEN ST (DSL-TRLR MTD)	PU-402/M	J35424	6115007223760	VCP	X			X			
GEN ST (GAS-TRLR MTD)	PU-617/M	J46384	6115007386335	VGE	X			X	X		
GEN ST (GAS-TRLR MTD)	PU332A/G	J49809	6115007386336	VJK	X			X	X		
GEN ST (GAS-TRLR MTD)	PU-618/M	J47480	6115007386337	VJL	X			X	X		
GEN ST (GAS-TRLR MTD)	PU409A/M	J47343	6115007386338	VJM	X			X	X		
GEN ST (GAS-TRLR MTD)	PU-619/M	J42100	6115007386339	VJN	X			X	X		
GEN ST (GAS-TRLR MTD)	PU-620/M	J47617	6115007386340	VJO	X			X	X		
GEN ST (GAS-TRLR MTD)	PU564A/G	J49946	6115007386341	VJP	X			X	X		
GEN ST (DSL-TRLR MTD)	PU406A/M	J36383	6115007386342	VCR	X			X	X		
GEN ST (GAS-TRLR MTD)	PU375A/G	J41819	6115007532231	VMG	X			X	X		
GEN ST (GAS-TRLR MTD)	PU-681	J50195	6115007893656	VMR	X			X	X		
GEN ST (DSL-TRLR MTD)	PU-401/M	J35414	6115008232217	VLX	X			X	X		
GEN ST (DSL-TRLR MTD)	PU-495/G	J35801	6115008232218	VCT	X			X			
GEN ST (GAS-TRLR MTD)	PU-625/G	J46252	6115008733915	VGH	X			X	X		
GEN ST (DSL-TRLR MTD)	PU-551/M	J37205	6115008891307	VEU	X			X	X		
GEN ST (GAS-TRLR MTD)	PU-564/G	J50083	6115008891367	VJZ	X			X	X		
GEN ST (GAS-WHL MTD)	59B2-1A	J49055	6115009034948	VKB	X			X	X		
GEN ST (GAS-WHL MTD)	JHGV7.5A	J49055	6115009144642	VKG	X			X			
GEN ST (GAS-WHL MTD)	59B2-1B	J49055	6115009268335	VKC	X			X	X		
GEN ST (GAS-TRLR MTD)	PU375B/G	J41819	6115009316789	VL6	X			X	X		
GEN ST (GAS-TRLR MTD)	PU-629/G	J46392	6115009375555	VJV	X			X	X		
GEN ST (GAS-TRLR MTD)	PU-678/M	J50185	6115009378468	VMS	X			X	X		
GEN ST (DSL-TRLR MTD)	PU-405/M	J35492	6115009498409	VDP	X			X	X		
GEN ST (GAS-TRLR MTD)	PU-656/G	J50151	6115009893296	VMN	X			X			
GEN ST (GAS-WHL MTD)	MC-111	J49055	6115009995935	VKD	X			X	X		
GEN ST (DSL)	NONE	J40208	6115010306084		X			X			
GEN ST	MEP007B	J38712	6115010366374	VDS	X			X	X		
GEN ST (DSL-TRLR MTD)	PU495B/G	J35801	6115011340165	VDT	X			X	X		
GEN ST (DSL)	MEP 012A	J30093	6115011433850	VBF	X			X	X		
GEN ST (AVN GND SPT)	MEP-362A	G38140	6115011613992	VKE				X	X		

Figure E-2. Identification of required forms for combat/tactical vehicles and support equipment—Continued

ECC NOUN	MODEL	LIN	NSN	EIC	REG # REQ	2408-4 WPNS REC	2408-5 MWO	2408-9 A/T/L/G	2408-9 USAGE	DD2026 USAGE	2408-9 OVHL
GEN ST (DED-TRLR MTD)	PU-789/M	G35601	6115012089827	VIG	X			X	X		
GEN ST (DSL)	PU-794/G		6115012421665	VCZ	X			X			
GEN ST (DSL)	PU375C/G	NONE	6115012566354	VMW	X			X			
GEN ST (DSL-WHL MTD)	NONE	G52158	6115012655045	***	X			X	X		
GEN ST (DSL)	MEP-802A	G11966	6115012747387					X			
GEN ST (DSL)	MEP-804A	G12170	6115012747388	VG4				X			
GEN SET(DSL-SKID MTD)	MEP814A	G12238	6115012747393	VN4				X	X		
GEN ST (DSL)	MEP-803A	G74711	6115012755061					X			
GEN ST (DSL)	AN/MJQ32	G78238	6115012802300	VBB	X			X			
GEN ST (DSL)	AN/MJQ33	G78135	6115012802301	VGL	X			X	X		
GEN ST (DSL)	NONE	G41670	6115013031484	VJ2	X			X	X		
GEN ST (DSL)	GSA-30	G62642	6115013048183	VCI	X			X	X		
GEN ST (DSL)	GSA-15HY	G62574	6115013048185	VDV	X			X	X		
GEN ST (DSL)	PU-799	G53403	6115013134283	VK4	X			X	X		
GEN ST (DSL)	PU-806	G17460	6115013172133	VNB	X			X	X		
GEN ST (DSL)	PU-805	G78306	6115013172134	VF3	X			X	X		
GEN ST (DSL-TRLR MTD)	PU-804	G35919	6115013172135	VMZ	X			X	X		
GEN ST (DSL)	PU-803	G35851	6115013172136	VD4	X			X	X		
GEN ST (DSL)	PU-802	G53778	6115013172138	VD3	X			X	X		
GEN ST (DSL)	PU-798	G42170	6115013199032	VK5	X			X	X		
GEN ST (DSL)	PU-797	G42238	6115013320741	VKK	X			X	X		
GEN ST (DSL-TRLR MTD)	PU-798A	G42170	6115014133818	VNC	X			X	X		
GEN ST (DSL-TRLR MTD)	PU-797A	G42238	6115014133820	VND	X			X	X		
GEN ST (DSL-TRLR MTD)		G36237	6115014351565					X	X		
GEN ST (DED)	PU-803B/G	G35851	6115014706376	VF5	X			X	X		
PWR PLANT (ELEC-TM)	AN/MJQ-41B	P42194	6115014743776	VD6	X			X	X		
PWR PLANT (ELEC-TM)	AN/MJQ40B	P42126	6115014743783	VF6	X			X	X		
GEN ST (DSL-TRLR MTD)	MEP-810B	NO-LIN	6115014864032	***	X			X	X		
<b>QC COMPRESSORS</b>											
COMP RTY(DSL-TLR MTD)	M250RPV	E72804	4310000757064	DWL	X			X			
COMP RTY(DSL-TLR MTD)	6M250RPV	E72804	4310000782462	DWM	X			X			

Figure E-2. Identification of required forms for combat/tactical vehicles and support equipment—Continued

ECC NOUN	MODEL	LIN	NSN	EIC	REG # REQ	2408-4 WPNS REC	2408-5 MWO	2408-9 A/T/L/G	2408-9 USAGE	DD2026 USAGE	2408-9 OVHL
COMP RCP(GAS-WHL MTD)	415HGP3M	E71023	4310000826036	ZQR	X			X			
COMP RTY(DSL-WHL MTD)	DR-600	E73352	4310001364369	DWA	X			X			
COMP RTY(GAS-WHL MTD)	12021A	E70886	4310002315513	ZPC	X			X			
COMP RTY(DSL-TRL MTD)	DVY9M250	E72804	4310002483496	DWN	X			X			
COMP RTY(DSL TLR MTD)	M250		4310002569319	DWP	X			X			
COMP RCP(GAS-WHL MTD)	P4R15GJ	E70886	4310004025107	ZPD	X			X			
COMP RTY(DSL-TLR MTD)	RMS250	E72804	4310004713075	DWF	X			X			
COMP UNIT RTY (DSL)	NONE	E74500	4310004983791		X			X			
COMP UNIT RTY (GAS)	NONE	E74529	4310004983792		X			X			
COMP RTY(DSL-WHL MTD)	DR-600	E73352	4310005422525	DWE	X			X			
COMP RTY(GAS-TRK MTD)	J21 0FED	E73489	4310005425928	DWQ	X			X			
COMP RTY(DSL-WHL MTD)	ENG 600	E73352	4310006204056	DWC	X			X			
COMP RCP(GAS-WHL MTD)	15HGP5	E70886	4310006243212	ZQ7	X			X			
COMP RCP(GAS-WHL MTD)	P-4	E71023	4310006796917	ZRG	X			X			
COMP RTY(GAS-TRK MTD)	210GD3MS	E73489	4310006798697	DWR	X			X			
COMP RTY (SKID MTD)	RP125MS3	E72393	4310006910877	ZQA	X			X			
COMP UNIT RCP (GAS)	LP512	E70064	4310007332210	ZPF	X			X			
COMP RTY(GAS-TLR MTD)	BM452 EN	E70338	4310007332217	ZRK	X			X			
COMP RTY(GAS-TLR MTD)	M210 CFM	E72667	4310007973417	DWH	X			X			
COMP RTY(GAS-TLR MTD)	BGR-5M-1	E70338	4310008521745	ZPL	X			X			
COMP RTY(DSL-WHL MTD)	2016	E73352	4310008781905	DWD	X			X			
COMP RTY(DSL-TLR MTD)	250DCMS1	E72804	4310009527142	DWS	X			X			
COMP RTY (PWR DRVN)	AI		4310009845741		X			X			
COMP RTY (DED)	450CFM	E74508	4310010229895	DWU	X			X			
COMP RTY (DED)	950CFM	E74512	4310010265543		X			X			
COMP RTY(DSL-WHL MTD)	750DP	C72872	4310010533891	DWJ	X			X			
COMP UNIT RTY	NONE		4310010546647		X			X			
COMP RTY(GAS-TLR MTD)	15CFM	E70338	4310010696935	ZPZ	X			X			
COMP RCP(GAS-WHL MTD)	15CFM	E70886	4310010705615	ZP3	X			X			
COMP RTY(DSL-TLR MTD)	18M250	E72804	4310010794805	DWK	X			X			
COMP UNIT RTY (DSL)	D1252P	E74500	4310010845419		X			X			
COMP UT RCP(G-WHLMTD)	KA15-03P	E70886	4310010874314	ZQD	X			X			
COMP UNIT RCP (GAS)	20-910	E70064	4310011055794	ZP6				X			

Figure E-2. Identification of required forms for combat/tactical vehicles and support equipment—Continued

ECC NOUN	MODEL	LIN	NSN	EIC	REG # REQ	2408-4 WPNS REC	2408-5 MWO	2408-9 A/T/L/G	2408-9 USAGE	DD2026 USAGE	2408-9 OVHL
COMP RTY(DSL-TLR MTD)	250CFM	E72804	4310011583262	DWT	X			X			
COMP AIR	175Q	C12127	4310012034764		X			X			
COMP RTY(DED-WHL MTD)	750CFM	C67394	4310012912990		X			X			
COMP UNIT RCP	E576DTM	E70338	4310013644316	ZS3				X			
<b>QD TANK/PUMP UNITS</b>											
PUMP ASSY FLAMBL LIQ	US36ACG	P96845	4320004072583	ZC9	X			X			
PUMP CEN(GAS-WHL MTD)	KN6HS	P94359	4320004409808	ZJS	X			X			
PUMP CEN(GAS-WHL MTD)	US90CCG1	P94359	4320004901859	ZHC	X			X			
PUMP ASSY FLAMBL LIQ	G-RO4A12	P97051	4320006911071	ZCM	X			X			
PUMP CEN(GAS-WHL MTD)	K400S	P94222	4320008107311	ZHG	X			X			
PUMP ASSY FLAMBL LIQ	US36ACG	P96845	4320009169172	ZCR	X			X			
PUMP CEN(GAS WHL MTD)	600GPM	P94290	4320009351619	ZHM	X			X			
PUMP ASSY FLAMBL LIQ	ADC 1500	P97051	4320010923551	ZC4	X			X			
PUMP CEN(GAS-WHL MTD)	US90CCD1	P94359	4320011281836	ZHT	X			X			
PUMP ASSY FLAMBL LIQ	350GPM	P97119	4320011415154	ZDH	X			X			
PUMP UNIT CENTRF	NONE	P44549	4320011582954	ZHV	X			X			
PUMP CEN(DED-SKD MTD)	NONE	P35886	4320011813984	ZC6	X			X			
PUMP ASSY FLAMBL LIQ	LPP-TM	P97051	4320012157671	ZDR	X			X			
PUMP ASSY FLAMBL LIQ	W-8646	P97051	4320012464398	ZDS	X			X			
PUMP ASSY FLAMBL LIQ	LC350GPM	P97051	4320012595965	ZDT	X			X			
PUMP CENT	350GPM-W	P44549	4320013257714	ZTG	X			X			
PUMP CENTR	LC350BGP	P44549	4320013359671		X			X			
PUMP ASSY FLAMBL LIQ	350AGPM	P97051	4320013377538	ZTJ	X			X			
PUMP CENTRIF	PAD125B	P92030	4320013571930	ZDY	X			X			
PUMP ASSY FLAMBL LIQ	NONE		4320014373161		X			X			
TK-PUMP UT, LIQ 7E	7100	V12141	4930004269960	ZAL				X			
TK UNIT, FUEL DISP	TRLR MTD	V19950	4930007529983	ZDC	X			X			
TK-PUMP UT, LIQ HL	ND 2000	V12141	4930008778678	ZAR				X			
TK-PUMP UT, LIQ 7E	7130	V12141	4930011307281	ZBH				X			
TK UNIT, FUEL DISP	TRLR MTD A	V19950	4930013706079	ZBU	X			X			

Figure E-2. Identification of required forms for combat/tactical vehicles and support equipment—Continued

ECC NOUN	MODEL	LIN	NSN	EIC	REG # REQ	2408-4 WPNS REC	2408-5 MWO	2408-9 A/T/L/G	2408-9 USAGE	DD2026 USAGE	2408-9 OVHL
<b>QE LAUNDRY UNITS</b>											
LNDRY UNIT (TRLR MTD)	60LB CAP	L48315	3510001694735	ZKC	X			X			
LNDRY UNIT (TRLR MTD)	ELT9T	L48315	3510007825294	ZKF	X			X			
LNDRY UNIT (TRLR MTD)	MIL44142	L48315	3510011976742	ZVG	X			X			
LNDRY UNIT (TRLR MTD)	K-S-M85	L48315	3510012229301	ZV9	X			X			
LNDRY UNIT (TRLR MTD)	M85-100	L48315	3510012918169	ZLF	X			X			
LNDRY UNIT (TRLR MTD)	M85-200	L48315	3510013655687	ZLG	X			X			
<b>QF AIR CONDITIONERS (TRLR MTD)</b>											
AIR COND (TRLR MTD)	A60	A26373	4120008070669	VV2	X			X			
AIR COND (TRLR MTD)	A60	A26510	4120008070670	VV3	X			X			
AIR COND (TRLR MTD)	36 60000	A26715	4120009261204	VVA	X			X			
AIR COND (TRLR MTD)	208V	A26271	4120009305700	VTF	X			X			
<b>QG WELDING MACHINES</b>											
WLD MACH MLR	33A/B/SP	Y47707	3431000676742	2A7	X			X			
WLD MACH ARC	GR-202-S	Y45652	3431002489327		X			X			
WLD SHOP (TRLR MTD)	300 AMP	Y48255	3431002875404	2AD	X			X			
WLD MACH (SKID MTD)	NONE	W47364	3431010798439	2AA	X			X			
WLD SHOP (TRLR MTD)	NONE	Y48323	4940009357821	2AE	X			X			
WLD SHOP (TRLR MTD)	NONE	W48391	4940010901231	2AB	X			X			
WLD SHOP (TRLR MTD)	OXY-ACET	W48391	4940013416232	2GA	X			X			
WLD SHOP	NONE	W48391	4940014549877	2FT	X			X			
<b>QH LUBRICATING AND SERVICING UNITS</b>											
LUB SVC UT (TRLR MTD)	9017651	L85283	4930000179167	ZAA	X			X			
LUB SVC UT (TRLR MTD)	NONE		4930005422336		X			X			
LUB SVC UT (TRLR MTD)	ENG-2	L85146	4930005424766	ZAM	X			X			
LUB SVC UT (TRLR MTD)	ENG-2	L85146	4930005424767	ZAQ	X			X			
LUB SVC UT (TRLR MTD)	ENG-3A	L85283	4930005482766	ZAP	X			X			

Figure E-2. Identification of required forms for combat/tactical vehicles and support equipment—Continued

ECC NOUN	MODEL	LIN	NSN	EIC	REG # REQ	2408-4 WPNS REC	2408-5 MWO	2408-9 A/T/L/G	2408-9 USAGE	DD2026 USAGE	2408-9 OVHL
LUB SVC UT (TRLR MTD)	ENG-2	L85146	4930008113533	ZAW	X			X			
LUB AND SVC	NONE		4930008428315		X			X			
LUB SVC UT (TRLR MTD)	251-3257	L85283	4930008577160	ZAX	X			X			
LUB SVC UT (TRLR MTD)	251-437	L85283	4930008925067	ZAS	X			X			
LUB SVC UT (GAS)	ENG-3	L85283	4930009354451	ZBF	X			X			
LUB SVC UT (AIR)	4-DRUM		4930010121034		X			X			
LUB SVC UT	178A-85	L85283	4930012300781	ZVQ	X			X			
LUB SVC UT	PM92-133	L85283	4930013655725	ZVR	X			X			
<b>QJ WATER PURIFICATION UNITS</b>											
WTR PURIF EQUIP SET	TRK MTD	Y35486	4610002026925	ZIB	X			X			
WTR PURIF EQUIP SET	TRK MTD	Y36034	4610002028701	ZIC	X			X			
WTR PURIF EQUIP	TRLR MTD	Y35212	4610005404024	ZI6	X			X			
WTR PURIF EQUIP SET	TRLR MTD	W35417	4610010268980	ZIP	X			X			
WTR PURIF	TRLR MTD	NONE	4610010932380	ZII	X			X			
WTR PURIF (TRLR-MTD)	NONE	W47225	4610012198707	ZHN	X			X			
WTR PURIF	NONE	NONE	4610012342190	***	X			X			
WTR PURIF (TRLR-MTD)	NONE	NONE	4610012342196	***	X			X			
WTR PURIF (TRLR-MTD)	WSPES1	W35417	4610012952720	***	X			X			
WTR PURIF (TRLR-MTD)	WPES10	W35417	4610013416289	ZU4	X			X			
WTR PURIF (TRLR-MTD)	ROWPU-1	W47225	4610013711790	ZH2	X			X			
<b>QM CHEMICAL PROTECTION</b>											
DECON APPR (SKID MTD)	M12A1	F81880	4230009269488	5FB				X			
SHELTER SYSTEM	M51	T00474	4240008544144	5GA	X			X			
WTR PRETMT DECON SET	CB AGENT	Y35109	4610008800278	ZJE	X			X			
<b>QN LIGHTING EQUIPMENT</b>											
FLOODLIGHT TELESCOPE	OG4-2TMA	H79426	6230001812498	UAW	X			X			
FLOODLIGHT SET	TRLR MTD	H79084	6230003835537	YXW	X			X			
FLOODLIGHT SET	TRLR MTD	F79334	6230010565238	YXT	X			X			

Figure E-2. Identification of required forms for combat/tactical vehicles and support equipment—Continued

ECC NOUN	MODEL	LIN	NSN	EIC	REG # REQ	2408-4 WPNS REC	2408-5 MWO	2408-9 A/T/L/G	2408-9 USAGE	DD2026 USAGE	2408-9 OVHL
<b>QP POWER PLANTS/UNITS</b>											
POWER PLANT (ELECT)	AN/MJQ16	P41832	6115000331395	VJC	X			X	X		
POWER PLANT (ELECT)	AN/MJQ18	P28015	6115000331398	VJD	X			X	X		
POWER PLANT (ELECT)	AN/MJQ10	P27819	6115000567906	VDA	X			X	X		
POWER PLANT (ELECT)	AN/MJQ11	P27821	6115001348485	VCQ	X			X	X		
POWER PLANT (ELECT)	AN/MJQ-12A	P27823	6115002571602	VEL	X			X	X		
POWER PLANT (ELECT)	AN/MJQ10A	P27819	6115003949582	VCO	X			X	X		
POWER PLANT (ELECT)	NONE	BB9024	6115003949583	VEN	X			X	X		
POWER PLANT (ELECT)	AN/MJQ15	P28075	6115004007591	VLO	X			X	X		
POWER PLANT (ELECT)	AN/MJQ-5	P27800	6115009517442	VEX	X			X	X		
PWR PLT ELECT-PATRIOT	AN/MJQ21	P27887	6115010569000	VIH	X			X	X		
PWR PLT ELECT-PATRIOT	AN/MJQ24	P42114	6115011022524	VIC	X			X	X		
POWER PLANT (ELECT)	AN/MJQ25	P42364	6115011537742	VMP	X			X	X		
POWER PLANT (ELECT)	AN/MJQ40	P42126	6115012996033	VNA	X			X	X		
POWER PLANT (ELECT)	AN/MJQ39	P42614	6115012996034	VD2	X			X	X		
POWER PLANT (DIESEL)	AN/MJQ37	P42262	6115012996035	VK2	X			X	X		
POWER PLANT (ELECT)	AN/MJQ41	P42194	6115013037896	VF2	X			X	X		
POWER PLANT (ELECT)	AN/MJQ38	P42330	6115013134214	VK3	X			X	X		
POWER PLANT (ELECT)	AN/MJQ36	P28151	6115013134215	VKI	X			X	X		
POWER PLANT (ELECT)	AN/MJQ35	P28083	6115013134216	VKJ	X			X	X		
POWER PLANT (ELECT)	AN/MJQ42		6115013228583		X			X	X		
POWER PLANT (ELECT)	PU-804B	G35919	6115014711507	IM2	X			X	X		
<b>QQ REPRODUCTION EQUIPMENT</b>											
PRINT PLT (STLR MTD)	NONE	P61528	3610008893262	YDR	X			X			
<b>QR TOPOGRAPHI/MEASURING/SURVEYING/MAPPING</b>											
TOPO REPRODUCTION SET	PLATE	P03804	3610002947829	YGK	X			X			
TOPO REPRODUCTION SET	PRESS ST	P50154	3610003444705	YEP	X			X			
TOPO REPRODUCTION SET	PHOTOMEC	N87960	3610006911707	YFX	X			X			
TOPO REPRODUCTION SET	MAP LO	M08138	3610010226633	YF6	X			X			

Figure E-2. Identification of required forms for combat/tactical vehicles and support equipment—Continued

ECC NOUN	MODEL	LIN	NSN	EIC	REG # REQ	2408-4 WPNS REC	2408-5 MWO	2408-9 A/T/L/G	2408-9 USAGE	DD2026 USAGE	2408-9 OVHL
TOPO REPRODUCTION SET	PLATE	Z49216	3610010226634		X			X			
TOPO REPRODUCTION SET	PHOTOMEC	P32316	3610010226635	YF7	X			X			
TOPO REPRODUCTION SET	PRESS ST	P50154	3610011051744	YF9	X			X			
TOPO MAPPING SET	NONE	R52776	6675005264629	YIN	X			X			
TOPO MAPPING SET	PHOTOMPG	N87460	6675005264631	YIO	X			X			
TOPO MAPPING SET	COPY/SUP	F13075	6675005264824	YIR	X			X			
TOPO MAPPING SET	MULTIPLX	M83242	6675005264836	YIS	X			X			
TOPO SPT ST(STLR MTD)	RECT II	T05749	6675011055759	YTU	X			X			
TOPO SPT ST(STLR MTD)	COLL SEC	T02041	6675011055760	YT7	X			X			
TOPO SPT ST(STLR MTD)	INFO SEC	T03673	6675011055762	YT9	X			X			
TOPO SPT ST-TRK VAN	DIV SPT	T02109	6675011055764	YJ4	X			X			
TOPO SPT ST(STLR MTD)	MOS/DRAF	T08523	6675011066815	YTV	X			X			
<b>QS REPAIR SHOP EQUIPMENT</b>											
SHOP EQ GEN PURP	EOD	S31232	2320012098823	2MA	X			X	X		X
LIFTPLTF (WHL MTD)	KD-26	P05757	4910010957504	FSJ	X			X			
INST RPR SHOP TRK MTD	M185A3	K90188	4940000771638	BMW	X			X	X	X	X
SHOP EQ ELECT RPR	SEER1968	T10412	4940001598846	2CA	X			X			
SHOP EQ ELECT RPR	SER-1968	T10275	4940001598847	2CB	X			X			
SHOP EQ ORG RPR	S WEST	T13152	4940001642719	2CC	X			X	X		X
SHOP EQ CONT MAINT	CMU-5	T10138	4940001654019	2CD	X			X	X		X
SHOP EQ ELECT RPR	SER-1961	T10275	4940001654020	2CE	X			X			
SHOP EQ GEN PURP RPR	SGPRSM68	T10549	4940001654021	2CF	X			X			
SHOP EQ ORG RPR	ENG-40	T13152	4940001654022	2CG	X			X	X		X
SHOP EQ ORG RPR	MEDL1956	T13152	4940001654023	2CH	X			X	X		X
SHOP EQ GEN PURP RPR	ENG43-59	T10549	4940001654024	2CJ	X			X			
SHOP EQ CONT MAINT	CMU-6	T10138	4940001654025	2CK	X			X	X		X
SHOP EQ CONT MAINT	SECM1960	T10138	4940001654026	2CL	X			X	X		X
SHOP EQ ELECT RPR	VAN-1959	T10275	4940001693036	2CM	X			X			
SHOP EQ ELECT RPR	VAN15777	T10275	4940001693037	2CN	X			X			
SHOP EQ ELECT RPR	SEER1963	T10412	4940001693038	2CP	X			X			
SHOP EQ ORG RPR	SMGPR-61	T13152	4940001693039	2CQ	X			X	X		X

Figure E-2. Identification of required forms for combat/tactical vehicles and support equipment—Continued

ECC NOUN	MODEL	LIN	NSN	EIC	REG # REQ	2408-4 WPNS REC	2408-5 MWO	2408-9 A/T/L/G	2408-9 USAGE	DD2026 USAGE	2408-9 OVHL
SHOP EQ ORG MAINT	MEDL-1954	T13152	4940001693040	2CR	X			X	X		
SHOP EQ ORG RPR	SEORL-66	T13152	4940001693041	2CS	X			X	X		X
SHOP EQ CONT MAINT	CMU-3	T10138	4940001693042	2CT	X			X	X		X
SHOP ELECT(STLR MTD)	ASM190A	H01857	4940001776835	JFB	X			X			
SHOP EQ CONT MAINT	MDL 993	T10138	4940001957712	2CU	X			X	X		X
SHOP EQ CONT RPR	VEH MTD	T10180	4940002096219	2HL	X			X	X		X
ELECT SHOP (STLR MTD)	ASM-189A	H01855	4940002346114	JFC	X			X			
SHOP EQ GEN PURP RPR	MIL45538	T10549	4940002874894	2CV	X			X			
SHOP EQ ORG RPR	MIL45537	T13152	4940002949516	2CW	X			X	X		X
SHOP EQ ELECT RPR	MIL52330	T10275	4940002949517	2DA	X			X			
SHOP EQ CONT MAINT	MIL45855	T10138	4940002949518	2CX	X			X	X		X
SHOP EQ ELECT RPR	MIL52377	T10412	4940002949542	2CY	X			X			
INST RPR SHOP TRK MTD	M185	K90188	4940003000306	BM9	X			X	X		X
SHOP EQ CONT MAINT	AVNC6217	T10138	4940004950118	2CZ	X			X	X		X
SHOP EQ GEN PURP RPR	MED-1952	T10549	4940004976412	2C2	X			X			
SHOP EQ GEN PURP RPR	SGPRSM61	T10549	4940004976413	2C3	X			X			
ELECT SHOP (STLR MTD)	ASM-189	H01855	4940008778730	JFG	X			X			
SHOP ELECT(STLR MTD)	ANASM190	H01857	4940009650317	JFJ	X			X			
INST RPR SHOP TRK MTD	M185A1	K90188	4940009733995	BNA	X			X	X		
INST RPR SHOP TRK MTD	M185A2	K90188	4940009878799	BM8	X			X	X	X	X
MA POWER UNIT	GPC28AF		4940009973172		X			X			
SHOP EQ GEN PURP RPR	SGPRSM6	T10549	4940010063229	2C4	X			X			
SHOP EQ CONT MAINT	SECM1975	T10138	4940010162262	2C5	X			X	X		X
SHOP EQ ELECT RPR	SER-1976	T10275	4940010225322	2C6	X			X			
SHOP EQ ORG RPR	SEORL118	T13152	4940010282672	2C7	X			X	X		X
SHOP EQ ELECT RPR	S/EQ	T10275	4940010964475	2C8	X			X			
SHOP EQ ELECT RPR	NONE	T10412	4940011107422	2C9	X			X			
SHOP EQ ELECT	NONE	T10275	4940011503113	2DL	X			X			
SHOP EQ GEN PURP(ENG)	NONE	S30914	4940012098824	2MB	X			X	X		X
SHOP EQ GEN PURP(ORD)	NONE	S30982	4940012098825	2MC	X			X	X		X
ELECT SHOP (STLR MTD)	ASM-189B	H01855	4940012119938		X			X			X
SHOP EQ ELECT RPR	CL-B05	T10275	4940012342322	ZFP	X			X			
SHOP EQ GEN PURP RPR	STRLR MTD	T10549	4940012355080	***	X			X			

Figure E-2. Identification of required forms for combat/tactical vehicles and support equipment—Continued

ECC NOUN	MODEL	LIN	NSN	EIC	REG # REQ	2408-4 WPNS REC	2408-5 MWO	2408-9 A/T/L/G	2408-9 USAGE	DD2026 USAGE	2408-9 OVHL
SHOP EQ ORG RPR	SEORTM	T13152	4940012360166	2FN	X			X	X		X
ELECT SHOP (STLR MTD)	ASM-189C	H01855	4940012749959	JFR	X			X			
SHOP EQ CONT MAINT	NONE	S25681	4940013338470	2FQ	X			X	X		
SHOP EQ CONT MAINT	M1097A2		4940013338471		X			X	X		
ELECT SHOP (STLR MTD)	AN/ASM-190B	H01857	4940013870587	IW5	X			X			
SHOP ELECT(STLR MTD)	TSM-191(V)	S38625	4940014450086	***	X			X			
FORWARD REPAIR SYS	NONE		4940014637940	DV9				X			
<b>QU FIREFIGHTING EQUIPMENT</b>											
TRUCK FF	750	X44735	4210001067432	ZMA	X			X	X		X
TRUCK FF	750W	X44735	4210001067433	ZMB	X			X	X		X
TRUCK FF	0814	X44735	4210001501426	ZMC	X			X	X		X
TRUCK FF	M44WLF	X44941	4210002259127	ZME	X			X	X		X
TRUCK FF	11407	X44735	4210002366260	ZMO	X			X	X		X
TRUCK FF (FOAM/WTR)	M454A2	X44941	4210004490431	ZMF	X			X	X		X
TRUCK FF	M45A2	X44941	4210009283515	ZMG	X			X	X		X
TRK FF	XM1142	Z42024	4210014861035	***	X			X	X		X
<b>QV SPECIAL SHOP EQUIPMENT</b>											
SHOP EQ VWV BASE MAINT	NONE	T16988	3220002708630	YXA	X			X			
CLOTHING RPR SHOP	8700337		3530008192007	YAA	X			X			
TEXTILE RPR SHOP	SHOP Y		3530008192008		X			X			
TEXTILE RPR SHOP	NONE		3530008800595		X			X			
CLOTHING RPR SHOP	8700680		3530009998577	YAB	X			X			
CLOTHING RPR SHOP	8700680	E40961	3530010152220	YAI	X			X			
CLOTHING RPR SHOP	8700337L	E40961	3530010179124	YAM	X			X			
CLOTHING RPR SHOP	T2WC51LP	E40961	3530010330851	YAN	X			X			
CLOTHING RPR SHOP	NONE		3530010597076		X			X			
CLOTHING RPR SHOP	NA-79	E40961	3530010753503	YAC	X			X			
CLOTHING RPR SHOP	NONE	BB9056	3530011333494	YAD	X			X			
PRES/PACK EQ ST	STRLRMTD	P46938	3540002939180	YXD	X			X			
SHOP SET ACFT MAINT	A-2	T21372	4920006212033	UB4	X			X			

Figure E-2. Identification of required forms for combat/tactical vehicles and support equipment—Continued

ECC NOUN	MODEL	LIN	NSN	EIC	REG # REQ	2408-4 WPNS REC	2408-5 MWO	2408-9 A/T/L/G	2408-9 USAGE	DD2026 USAGE	2408-9 OVHL
SHOP SET ACFT MAINT	C-1	T22194	4920006212039	UCA	X			X			
SHOP SET ACFT MAINT	C-2	T22331	4920006212040	UCB	X			X			
SHOP SET ACFT MAINT	C-3	T22468	4920006212041	UCC	X			X			
SHOP SET ACFT MAINT	C-4	T22605	4920006212042	UCD	X			X			
SHOP SET ACFT MAINT	C-5	T22742	4920006212043	UCE	X			X			
SHOP SET ACFT MAINT	C-6	T22879	4920006212044	UCF	X			X			
SHOP SET ACFT MAINT	C-7	T23016	4920006212045	UCG	X			X			
SHOP SET ACFT MAINT	C-8	T23153	4920006212046	UCH	X			X			
SHOP SET ACFT MAINT	C-10	T23701	4920006212047	UCJ	X			X			
SHOP SET ACFT MAINT	C-9	T23290	4920006496509	UCK	X			X			
SHOP SET ACFT MAINT	C-11	T23427	4920006496510	UCL	X			X			
SHOP SET ACFT MAINT	B-5	T22057	4920006497098	UCM	X			X			
RADAR ANTENNA-TRK MTD	VADS	Q13633	4931004357746	3VA	X			X			
SHOP EQUIP (X-09)	ANTSM42		4935000876561					X			
SHOP EQUIP (X0-4)	AN/MSM43		4935004745272		X			X			
SHOP EQUIP (X-05)	ANMSM43		4935008060922		X			X			
SHOP EQUIP (X-08)	ANTSM42		4935009694080					X			
SUBSTATION	9502200A	U56519	6120004221047	VFD	X			X			
<b>QW DETECTION EQUIPMENT/RECON SYSTEM/BIO-AGENT</b>											
DETECTING SET MINE	4D5000	G02341	6665001810369	YPD				X			
DETECTING SET MINE	WURL232	G02478	6665008219020					X			
DETECTING SET MINE	TM P170	G02478	6665008794087		X			X			
DETECTING SET MINE	WURL324	G02478	6665009121846					X			
DETECTING SET MINE	AN/PRS-8	G02204	6665010799522	YPH				X			
RECON SYS NBC	M93	R41532	6665013232582	559	X			X	X		
RECON SYS NBC	M93A1	R41282	6665013721303	551	X			X	X		
<b>QY MISCELLANEOUS SUPPORT EQUIPMENT</b>											
TRANS AIRMOBLE HYD LF	17-502	X23227	1740009011870	UAL				X			
TRANS AIRMOBLE HYD LF	4000A2	X23227	1740009023132	UA8				X			
TRANS HYD LF	D735B	X23227	1740009309256	UA2	X			X			

Figure E-2. Identification of required forms for combat/tactical vehicles and support equipment—Continued



ECC NOUN	MODEL	LIN	NSN	EIC	REG # REQ	2408-4 WPNS REC	2408-5 MWO	2408-9 A/T/L/G	2408-9 USAGE	DD2026 USAGE	2408-9 OVHL
TRANS AIRMOBILE HYD LF	NONE		1740010650571		X			X			
TRANS AIRMOBILE HYD LF	NONE		1740011335671		X			X			
PNEU TOOL COMP OUTFIT	NONE	P11866	3820009508584	FBD	X			X	X		

**QZ TOOLS AND TEST EQUIPMENT/TRAINING AIDS/DEVICES**

TOOL OUTFIT HY SYS	TST/RPR	T30377	4940010365784	2DD	X			X			
PROVER TK(TLR/TRKMTD)	NONE	P83026	6680011315110		X			X			

**S INSTALLATIONS DEPOT PECULIAR SERVICE EQUIPMENT**

**SY LAWN MOWERS, SNOW REMOVAL, GROUND MAINTENANCE, AND OTHER MAINTENANCE AND SERVICES (M&S) EQUIPMENT**

LAWN RTR (SP-RIDING)	MOWER	M79603	3750000612815					X			
MOWER TRCR RIDING	7RL HYD	M79708	3750002365199		X			X			
LAWN MOWER RIDING	NONE	M79535	3750002517357		X			X			
MOWER LAWN TURF	NONE	M19576	3750005015698		X			X			
MOWER RTR (TRCTR TOW)	NONE	M55859	3750005554639		X			X			
MOWER LAWN TRCTR	6 FT	M79640	3750007297030		X			X			
MOWER ATT (TRCTR TOW)	NONE	M79671	3750008281462		X			X			
MOWER ATT (TRCTR TOW)	741 CORS	M79400	3750010047848		X			X			
LAWN MOWER RIDING	72IN CUT	M79535	3750010152249		X			X			
LAWN MOWER RIDING	76IN CUT	M79661	3750010191563		X			X			
MOWER LAWN TRCTR	133IN CUT	M79593	3750010381398		X			X	X		
LAWN MOWER	NONE	000000	3750011656768		X			X			
SNOW REMVL UT(TRKMTD)	TU3	T87602	3825000182121	FRD	X			X			
SNOWFLOW (TRK MTD)	NONE	T88838	3825004087361	FRM	X			X			
SNOWFLOW (TRK MTD)	NONE	T88821	3825004090090	FRL	X			X			
SNOW REMOVAL UNIT	NONE	KK5423	3825005423209					X			
SNOW REMVLUT (TRKMTD)	S 349 V	T87568	3825008107074	EF3	X			X			
SNOW BLOWER(TRCT ATT)	541	T86994	3825010146282		X			X			

**W FURNITURE AND APPLIANCES**

**Figure E-2. Identification of required forms for combat/tactical vehicles and support equipment—Continued**

ECC NOUN	MODEL	LIN	NSN	EIC	REG # REQ	2408-4 WPNS REC	2408-5 MWO	2408-9 A/T/L/G	2408-9 USAGE	DD2026 USAGE	2408-9 OVHL
<b>WT KITCHEN EQUIPMENT</b>											
GRILL CHAR (MOBILE)	18X56 IN	C27075	7310001401500		X				X		
GRILL CHAR (MOBILE)	18X28 IN	C27075	7310001401502	***					X		
KITCHEN FLD (TLR MTD)	NONE	L28351	7360001387782	YBC	X				X		
KITCHEN FLD (TLR MTD)	MFK75A	L28351	7360010920470	YBL	X				X		
KITCHEN FLD (TLR MTD)	MKT-82	L28351	7360011556020	YBM	X				X		
KITCHEN FLD (TLR MTD)	MKT-85	L28351	7360012141176	YBT	X				X		
KITCHEN FLD (TLR MTD)	MKT-90	L28351	7360013132238	YCF	X				X		
KITCHEN FLD (TLR MTD)	MKT-95	L28351	7360014174635	YCG	X				X		
KITCHEN FLD (TLR MTD)	NONE	C27633	7360014733408	YB6	X				X		
KITCHEN FLD (TRL MTD)	NONE	NO-LIN	7360014838617	***	X				X		

**Figure E-2. Identification of required forms for combat/tactical vehicles and support equipment—Continued**

ECC NOUN	MODEL	LIN	NSN	EIC	REG #	2408-4	2408-5	2408-9	2408-9	DD2026	2408-9
					REQ	WPNS REC	MWO	A/T/L/G	USAGE	USAGE	OVHL
<b>M RAILWAY EQUIPMENT</b>											
<b>MA CARS</b>											
R R CAR (SPOTTER)	8400 LBS	R02838	2210001420230	XD6							X
R R CAR (SPOTTER)	1300LB	R02838	2210005433289	XF5							X
R R CAR (CABOOSE)	50-TON	Q99037	2220000072176								X
R R CAR (FLAT)	140-TON	R00406	2220001029674	XDT							X
R R CAR BOX (WOOD)	30-TON	Q98454	2220001420200	XD5							X
R R CAR (HOPPER)	50-TON	R01468	2220001538893	XCF							X
R R CAR FLAT (WELL)	90-TON	R00458	2220002114324	XD8							X
R R CAR (SIDE DUMP)	NONE	R02701	2220002614841	XEB							X
R R CAR (FLAT)	50-TON	Q99687	2220002615861	XEC							X
R R CAR (FLAT)	40-TON	R00098	2220002618048	XCB							X
R R CAR TNK (CHEM)	NONE	R02975	2220002618630	XED							X
R R CAR TNK (CHEM)	NONE	R02975	2220002619997	XEE							X
R R CAR TNK (CHEM)	NONE	R02975	2220002619998	XEF							X
R R CAR TNK (CHEM)	NONE	R02975	2220002619999	XEG							X
R R CAR TANK (POL)	ICC103	R03523	2220002620003	XEH							X
R R CAR TANK (POL)	103W	R03523	2220002620004	XEJ							X
R CAR TROOP (HOSP)	NONE	R01605	2220002620006	XEK							X
R R CAR TNK (PETR)	10000G	R03386	2220002620752	XCD							X
R R CAR (REFRIG)	40-TON	R02564	2220002620754	XEL							X
R R CAR (GONDOLA)	50-TON	R00646	2220002620755	XEM							X
R R CAR (GONDOLA)	50-TON	R01057	2220002621372	XEP							X
R R CAR TNK (CHEM)	NONE	R02975	2220002623980	XEQ							X
R R CAR TNK (CHEM)	PHOS	R02975	2220002623981	XER							X
R R CAR (FLAT)	80-TON	Q99824	2220002638846	XCQ							X
R R CAR (FLAT)	100-TON	Q99550	2220002638935	XET							X
R R CAR FLAT (PASS)	100-TON	Q99413	2220002638936	XEU							X
R R CAR (BOX)	50-TON	Q98728	2220002641826	XEV							X
R R CAR TNK (CHEM)	NONE	R02975	2220002701355	XEX							X

Figure E-3. Identification of required forms for railway equipment

ECC NOUN	MODEL	LIN	NSN	EIC	REG #	2408-4	2408-5	2408-9	2408-9	DD2026	2408-9
					REQ	WPNS REC	MWO	A/T/L/G	USAGE	USAGE	OVHL
R R CAR (FLAT)	50-TON	R00098	2220002780800	XE3							X
R R CAR (FLAT)	150-TON	Q99550	2220002878130	XE4							X
R R CAR (GONDOLA)	40-TON	R00783	2220002878507	XCG							X
R R CAR (FLAT)	80-TON	Q99824	2220002878899	XE5							X
R R CAR (FLAT)	70-TON	R00372	2220002942469	XFA							X
R R CAR TNK (CHEM)	S/A 103A	R02975	2220002992857	XFB							X
R R CAR (GONDOLA)	56-1/2IN	R01194	2220002992866	XCH							X
R R CAR (FLAT)	200-TON	Q99550	2220003519814	XFE							X
R R CAR FLAT (WELL)	135-TON	R00484	2220003574924	XFD							X
R R CAR (BOX)	40-TON	Q98728	2220003770228	XFG							X
R R CAR (FLAT)	150-TON	R00432	2220003917004	X							X
R R CAR TNK (CHEM)	NONE	R02975	2220004613593	XFL							X
R R CAR (FLAT)	300-TON	R00089	2220005200794	XFP							X
R R CAR TNK (CHEM)	AN103AL	R02975	2220005299090	XFR							X
R R CAR (TANK)	POL20000	R03553	2220005332740	X							X
R R CAR TANK (POL)	USG A	R03523	2220005336484	XFS							X
R R CAR TNK (CHEM)	MURTC	R02975	2220005336940	XFV							X
R R CAR TNK (CHEM)	NTRCACID	R02975	2220005346142	XFZ							X
R R CAR (FLAT)	100-TON	Q99550	2220005408830	XF2							X
R R CAR (FLAT)	NONE	R00098	2220005408831	XF3							X
R R CAR (HOPPER)	70-TON	R01468	2220005420215	XF4							X
R R CAR (FLAT)	80-TON	R00235	2220005540453	XC7							X
R R CAR TANK (WATER)	NONE	R03660	2220005542724	XF8							X
R R CAR TANK (PETR)	10800G	R03112	2220005542726	XF9							X
R R CAR TANK (POL)	ARA 07	R03523	2220005756551	XGB							X
R R CAR (GONDOLA)	40-TON	R00646	2220005926648	XGC							X
R R CAR (FLAT)	40-TON	Q99687	2220005929832	XGD							X
R R CAR (BOX)	70-TON	Q98825	2220005978727	XGE							X
R R CAR TNK (PETR)	10800G	R03386	2220006164902	XGF							X
R R CAR (FLAT)	36 IN	Q99276	2220006600938	XGI							X
R R CAR BOX (AMMO)	50-TON	Q98796	2220007277112	XGM							X
R R CAR (BOX)	40-TON	Q98728	2220007287306	XGN							X
R R CAR (GONDOLA)	60 IN	R01194	2220008030954	XGQ							X

Figure E-3. Identification of required forms for railway equipment—Continued

ECC NOUN	MODEL	LIN	NSN	EIC	REG # REQ	2408-4 WPNS REC	2408-5 MWO	2408-9 A/T/L/G	2408-9 USAGE	DD2026 USAGE	2408-9 OVHL
R R CAR (REFRIG)	50-TON	RC2564	2220008751536	ZMU				X			
R R CAR (REFRIG)	DISAMB	RC2564	2220008978337	XGY				X			
R R CAR (GUARD)	DS NAC	RC1331	2220008981755	XCX				X			
R R CAR TANK (CHEM)	SA20000	R03591	2220009307001	XGZ				X			
R R CAR (CABOOSE)	50-TON	Q99037	2220010270385					X			
R R CAR (MP GUARD)	NONE	RC2165	2220010343076	XG7				X			
R R CAR (FLAT)	140-TON	R99755	2220010586377	XG8				X			
R R CAR (HOPPER)	100-TON	RC1468	2220012373718	XDI				X			
<b>MB MAINTENANCE CARS</b>											
R R CAR MNT MULTGAGE	6T/4 WHL	RC3797	2230001649583					X			
R R MAINT CAR (TRLR)	5-TON	RC4482	2230002620758	XFI				X			
R R MAINT CAR (DS)	2-MAN	RC7085	2230002620759					X			
R R MAINT CAR (DS)	4-MAN	RC7496	2230002620761	XDC				X			
R R MAINT CAR (FS)	4-MAN	RC7633	2230002620762	XDD				X			
R R MAINT CAR (DS)	8-MAN	RC7770	2230002620763	XEI				X			
R R MAINT CAR	8-MAN	RC7907	2230002620764	XEN				X			
R R MAINT CAR	8-MAN	RC5578	2230002620766	XDO				X			
R R MAINT CAR	28-MAN	RC7359	2230002880319	XE9				X			
R R MAINT CAR	10-MAN	RC7770	2230009261053					X			
R R MAINT CAR	8-MAN	RC7770	2230010462814					X			
R R MAINT CAR	8-MAN	RC7770	2230011327915					X			
<b>MC DIESEL LOCOMOTIVES</b>											
LOCO DIESEL	NONE		2210001128510					X			
LOCO DIESEL	H12-44	L80769	2210002620751	XCC				X			
LOCO DIESEL	NONE		2210002878901	XE6				X			
LOCO DIESEL	SW8	L80358	2210003717535	XCI				X			
LOCO DIESEL	DE45	L80495	2210005299038	XCJ				X			
LOCO DIESEL (ELECT)	36 IN	L79810	2210005540784	XF7				X			
LOCO DIESEL	GP7L	L80769	2210005540785	XCK				X			
LOCO DIESEL	NHBIS	L80724	2210008043614	XCM				X			

Figure E-3. Identification of required forms for railway equipment—Continued

ECC NOUN	MODEL	LIN	NSN	EIC	REG # REQ	2408-4 WPNS REC	2408-5 MWO	2408-9 A/T/L/G	2408-9 USAGE	DD2026 USAGE	2408-9 OVHL
LOCO DIESEL	112-5708	L80724	2210008043615	XCN				X			
LOCO DIESEL	19B238G2	L80769	2210008145291	XCO				X			
LOCO DIESEL	19B238G1	L80769	2210008153521	XCP				X			
LOCO DIESEL	C27915	L80769	2210008199317	XCR				X			
LOCO DIESEL	RS-4-TC	L80832	2210008199318	XCS				X			
LOCO DIESEL	BB130	L80678	2210008199319	XCT				X			
LOCO DIESEL	ALCO 539	L80358	2210008199320	XCU				X			
LOCO DIESEL	L1600	L80724	2210008205451	XCV				X			
LOCO DIESEL	10-TON	L80221	2210008255050	XC8				X			
LOCO DIESEL (ELECT)	SW12	L80769	2210011193433	XOD				X			
LOCO DIESEL (ELECT)	60-TON	L80632	2210011582978	XCY				X			
LOCO DIESEL (ELECT)	80-TON	L80724	2210011582980	XC3				X			
LOCO DIESEL (ELECT)	NONE		2210013239175					X			
<b>MD CRANES</b>											
CRANE LOCO	25-TON	F37186	2230001749130	XDA				X			
CRANE LOCO	40-TON		2230001749131	XD7				X			
CRANE LOCO	40-TON	F37460	2230005542728	XDE				X			
CRANE LOCO	150-TON DS	F38008	2230006240180	XGH				X	X		
CRANE LOCO	HB1600	F37186	2230008098862	XDF				X			
CRANE LOCO	D13000C3	F37186	2230008099863	XDG				X			
CRANE LOCO	C90	F37186	2230008099865	XGR				X			
CRANE LOCO	840DE	F37460	2230009396649	XC9				X			
CRANE MULTI-P RAILWAY	360	C37162	2230011757299	XOH				X			
CRANE GANTRY (RAIL)	50-TON	F36756	3950010907712	EQA				X			
<b>ME OTHER</b>											
BALLAST REGULATOR RY	2FWJ	B22967	2230001101894	XDU				X			
SNOWPLOW RR (CAR MTD)	NONE	T88479	2230005299039	XFQ				X			
TRL MAINT RPR RAIL CA	NONE	T33619	2230013043005	***				X			

Figure E-3. Identification of required forms for railway equipment—Continued

ECC NOUN	MODEL	LIN	NSN	EIC	REG # REQ	2408-4 WPNS REC	2408-5 MWO	2408-9 A/T/L/G	2408-9 USAGE	DD2026 USAGE	2408-9 OVHL
<b>V NON-TACTICAL WHEELED VEHICLES (COMMERICAL DESIGN)</b>											
<b>VB TRUCKS, DUMP</b>											
TRUCK DUMP (PATCHER)	NONE	T43648	2320010752831	FNK	X			X	X		
TRK DUMP (5-1/2T-4X2)	19000GVM	X43571	2320010907815	FMG	X			X	X		
TRK DUMP (8T-4X2)	24000GVM	X43589	2320010907816	FMJ	X			X	X		
TRK DUMP (8-1/2T-4X2)	28000GVVW	X43589	2320010907817	FMK	X			X	X		
TRK DUMP (4-1/2T-4X2)	16000GVM	X43571	2320010907818	FMH	X			X	X		
TRK DUMP (8T-4X2)	24000GVM	X43589	2320010907819	FML	X			X	X		
TRK DUMP (5-1/2T-4X4)	19000GVM	X43982	2320010907820	FMM	X			X	X		
TRK DUMP (8T-4X4)	24000GVM	X43982	2320010907821	FMN	X			X	X		
TRK DUMP (7-3/4T-6X4)	34500GVVW	X44256	2320010907822	FMR	X			X	X		
TRK DUMP (10T-6X4)	39500GVVW	X44256	2320010907823	FMS	X			X	X		
TRK DUMP (8T-6X6)	36000GVVW	X44119	2320010907824	FMP	X			X	X		
TRK DUMP (10T-6X6)	51000GVVW	X44119	2320010907825	FMQ	X			X	X		
TRK DUMP (3-5CY-4X2)	NONE	X43564	2320010909532	FWH	X			X	X		
TRK DUMP (1-2CY-4X4)	NONE	X43447	2320010909533	FWJ	X			X	X		
TRK DUMP (3-5CY-4X4)	NONE	X43565	2320010911681	FXD	X			X	X		
TRK DUMP (2-4CY-4X2)	NONE	X43563	2320010911682	FXE	X			X	X		
TRK DUMP (1CY-4X2)	NONE	X43561	2320010919062	FXS	X			X	X		
TRK DUMP (FLAT BED)	NONE	T45244	2320011162966	FX4	X			X	X		
TRK DUMP (SLUDGE-6X4)	NONE	T43716	2320011458095	FYC	X			X	X		
TRK DUMP (55T-4X2)	QUARRY	T43273	2320012770244		X			X	X		
<b>VC TRUCKS, FIREFIGHTING</b>											
TRK FF POWERED PUMPER	NONE	X44701	4210001026466		X			X	X		
TRK FF 1000-2000 GAL	NONE	X45144	4210001344401		X			X	X		
TRK FF	TGM46FB		4210001654920		X			X	X		
TRK FF 1500 GAL 6X6	NONE	X45095	4210001846415		X			X	X		
TRK FF (DRY CHEMICAL)	NONE	T44805	4210002026247		X			X	X		
FF EQUIP SET (A/C)	CL530	H56391	4210002028076	ZMN	X			X	X		

Figure E-4. Identification of required forms for nontactical wheeled vehicles and special purpose

ECC NOUN	MODEL	LIN	NSN	EIC	REG # REQ	2408-4 WPNS REC	2408-5 MWO	2408-9 A/T/L/G	2408-9 USAGE	DD2026 USAGE	2408-9 OVHL
TRK FF (BRUSH/WATER)	NONE	X44739	4210002889121		X			X	X		
FF EQUIP SET (BRUSH)	CL530	H56528	4210003930349	ZMD	X			X	X		
FF EQUIP SET (STRUCT)	CL530	H56802	4210003930353	ZND	X			X	X		
TRK FF (SUPPRESSION)	D45LTW50		4210004022081		X			X	X		
TRK FF (CRASH/RESCUE)	PURPLE K	X39426	4210004845729	ZMH	X			X	X		
TRK FF(PUMP FOAM/WTR)	HC26	X44804	4210005422113	ZM7	X			X	X		
TRK FF(PUMP FOAM/WTR)	530BA	X44804	4210005422195	ZM8	X			X	X		
TRK FF	GPM 530BAW	X44804	4210005422196	ZM9	X			X	X		
TRK FF POWERED PUMPER	NONE	X44701	4210005777656	ZMR	X			X	X		
TRK FF POWERED PUMPER	NONE	X44701	4210008326952		X			X	X		
TRK FF (500 GPM)	NONE	X44684	4210008326953	ZMT	X			X	X		
TRK FF (500 GPM)	NONE	X44684	4210008664389		X			X	X		
TRK FF LDR WTR TOWER	NONE	X44718	4210009651254	ZMJ	X			X	X		
TRK FF	X38172	X38172	4210010061534					X	X		
TRK FF POWERED PUMPER	NONE	X44701	4210010254976		X			X	X		
TRK FF (BRUSH/STRUCT)	NONE	X44733	4210010262567	ZMK	X			X	X		
TRUCK FF	SM1012		4210010791223		X			X	X		
TRK FF (CRASH)	NONE	X45095	4210011379944		X			X	X		
FF EQUIP SET(TRK MTD)	NONE	H56391	4210011522699	ZML	X			X	X		
TRK FF (BRUSH/PUMPER)	NONE	T67209	4210011594823	ZM5	X			X	X		
TRK FF SET	NONE		4210011933621		X			X	X		
TRK FF POWERED PUMPER	NONE	X44701	4210012198763	ZMM	X			X	X		
TRK FF (DRY CHEMICAL)	NONE	T44807	4210012220668		X			X	X		
TRK FF	NONE	NO-LIN	4210012482110	***	X			X	X		
TRK FF (LDR FOAM)	WTR DSL	T96630	4210012908755		X			X	X		
<b>VD TRUCKS, HOPPER</b>											
TRK HOPPER (COAL)	SIZE 1	X48792	2320002734426	FLC	X			X	X		
TRK HOPPER (COAL)	SIZE 2	X48799	2320004634561	FMT	X			X	X		
<b>VE TRUCKS, MAINTENANCE</b>											
TRUCK MAINTENANCE	NONE		2320000088242		X			X	X		

Figure E-4. Identification of required forms for nontactical wheeled vehicles and special purpose—Continued

ECC NOUN	MODEL	LIN	NSN	EIC	REG # REQ	2408-4 WPNS REC	2408-5 MWO	2408-9 A/T/L/G	2408-9 USAGE	DD2026 USAGE	2408-9 OVHL
TRK MAINT GP REP SHOP	NONE	X54120	2320000976005	BLC	X			X	X		
TRK MAINT(LINE CONST)	MOD-3	X53406	2320001173418	FMX	X			X	X		
TRK MAINT(LINE CONST)	MOD-4	X53402	2320002248859	FMW	X			X	X		
TRK MAINT (TELEPHONE)	TY7CLB	X53790	2320002354815	FHR	X			X	X		
TRK MAINT (UTILITY)	TY13	X53856	2320002771396	FKE	X			X	X		
TRK MAINT (TELEPHONE)	TY6 C/B	X53572	2320002871991	FHD	X			X	X		
TRUCK MAINT	KR3603	X53572	2320003928190	FH8	X			X	X		
TRK MAINT (UTILITY)	TY6	X53851	2320004113970	FH9	X			X	X		
TRK MAINT(LINE CONST)	TY4 CLC	X53366	2320004371137	FKC	X			X	X		
TRK MAINT(LINE CONST)	TY4 CLD	X53400	2320004371140	FLD	X			X	X		
TRK MAINT(LINE CONST)	MOD-1	X53371	2320004634580	FMU	X			X	X		
TRK MAINT(LINE CONST)	MOD-2	X53376	2320004634582	FMV	X			X	X		
TRK, MAINTENANCE	3/4T 57 FORD	X53572	2320005424150	FHE	X			X	X		
TRK MAINT (TELEPHONE)	D200	X53572	2320007826886	FHG	X			X	X		
TRK MAINT (TELEPHONE)	C3603	X53572	2320007826889	FHH	X			X	X		
TRK MAINT (TELEPHONE)	F350	X53572	2320008922154	FHJ	X			X	X		
TRUCK MAINT	FORD 66 KOE	X53572	2320009263703	FHK	X			X	X		
TRUCK MAINT	FORD 66 STA	X53572	2320009263704	FHL	X			X	X		
TRUCK MAINT	FORD 66 KOE	X53572	2320009263707	FHM	X			X	X		
TRK MAINT (TELEPHONE)	66 KOE	X53572	2320009267000	FHN	X			X	X		
TRK MAINT (TELEPHONE)	F350	X53572	2320009267001	FHP	X			X	X		
TRK MAINT (TELEPHONE)	D200	X53572	2320009267032	FHQ	X			X	X		
TRK MAINT(LINE CONST)	LC 6X4	T54188	2320010777837	FVD	X			X	X		
TRK MAINT (RDS/GNDS)	NONE	X53430	2320010907903	FWC	X			X	X		
TRK MAINT (WTR/SEWER)	NONE	X53876	2320010909564	FLE	X			X	X		
TRUCK MAINTENANCE	4X2	X54200	2320010909565	FHS	X			X	X		
TRUCK MAINTENANCE	4X2	X53432	2320010909566	FHC	X			X	X		
TRK MNT RIG (2 1/2T)	4X2	X53426	2320010911724	FKD	X			X	X		
TRK MAINT (WHI-LIFT)	4X2	X53896	2320010911725	FXM	X			X	X		
TRK MAINT (WHI-LIFT)	4X2	X53886	2320010911726	FXN	X			X	X		
TRK MAINT (VAN-1/4T)	4X2	T53919	2320010917825	FGD	X			X	X		
TRK MAINT (1/4T)	4X2	T54265	2320010917826	FGE	X			X	X		
TRK MAINT (1T)	4X4	X54175	2320010919075	FGF	X			X	X		

Figure E-4. Identification of required forms for nontactical wheeled vehicles and special purpose—Continued

ECC NOUN	MODEL	LIN	NSN	EIC	REG # REQ	2408-4 WPNS REC	2408-5 MWO	2408-9 A/T/L/G	2408-9 USAGE	DD2026 USAGE	2408-9 OVHL
TRK MAINT (1T)	4X4	X54197	2320010919076	FHB	X			X	X		
TRK MAINT FURN CLN	NONE	T80860	2320011648367	FYD	X			X	X		
<b>VF TRUCKS, REFUSE/COLLECTIONS</b>											
TRK REFUSE (WHOPPER)	CL-B	X55832	2320001741610	FLK	X			X	X		
TRK REFUSE(MAT HNDLG)	TY1 CLB	X54433	2320002757932	DRE	X			X	X		
TRK REFUSE(MAT HNDLG)	TY1 CLA	X54428	2320002790683	DRD	X			X	X		
TRK REFUSE(MAT HNDLG)	TY-2CL-D	X54448	2320004589765	DRC	X			X	X		
TRK REFUSE(MAT HNDLG)	TY1CLD	X54445	2320004602564	DRB	X			X	X		
TRK REFUSE-TILT FRAME	NONE	X45187	2320004634584	FMY	X			X	X		
TRK REFUSE (WHOPPER)	CL-A	X55820	2320004898323	FKH	X			X	X		
TRK REFUSE (WHOPPER)	CL-D	X55839	2320004898324	FM6	X			X	X		
REFUSE HOISTING UNIT	TY-1	X55842	2320009636269	FLL	X			X	X		
REFUSE HOISTING UNIT	TY-3	X55847	2320009636270	FM7	X			X	X		
TRK DUMP REFUSE COLL	NONE	X43580	2320010911683	FXF	X			X	X		
TRK REFUSE BODY COLL	TY-F	B85318	2510001653943	FTG	X			X	X		
TRK REFUSE BODY	A-30		2510004904099		X			X	X		
TRK REFUSE BODY COLL	B-40	B85270	2510004904100	FTB	X			X	X		
TRK REFUSE BODY COLL	TY-E	B85306	2510004904101	FTF	X			X	X		
TRK REFUSE BODY COLL	A-40	B85296	2510004904102	FTE	X			X	X		
TRK REFUSE BODY COLL	TYP C	B85280	2510004904103	FTD	X			X	X		
TRK REFUSE BODY	A-20		2510004904104		X			X	X		
TRK REFUSE BODY COLL	TYP D	B85275	2510004904105	FTC	X			X	X		
TRK REFUSE BODY COLL	B-30	B85265	2510004905518	FTA	X			X	X		
TRK REFUSE PACKER	2 CU YD	E61002	3990001388304	FTM	X			X	X		
REFUSE HOISTING UNIT	8-9 CUYD	R66175	3990010463654	***	X			X	X		
<b>VH TRUCKS, TANK</b>											
TRK TANK (F/S)	19000GVW	X57682	2320010907800	FVW	X			X	X		
TRK TANK (F/S)	28000GVW	X57719	2320010907801	FVX	X			X	X		
TRK TANK (FSA)	19000GVW	X57682	2320010907802	FVY	X			X	X		
TRK TANK (FSA)	28000GVW	X57719	2320010907803	FVZ	X			X	X		

Figure E-4. Identification of required forms for nontactical wheeled vehicles and special purpose—Continued

ECC NOUN	MODEL	LIN	NSN	EIC	REG #	2408-4	2408-5	2408-9	2408-9	DD2026	2408-9
					REQ	WPNS REC	MWO	A/T/L/G	USAGE	USAGE	OVHL
TRK TANK (WATER)	16000GVW	X58778	2320010907804	FV2	X			X	X		
TRK TANK (WATER)	24000GVW	X58815	2320010907805	FV3	X			X	X		
TRK TANK (WATER)	34000GVW	X58815	2320010907806	FV4	X			X	X		
TRK TANK (WATER)	19000GVW	X58778	2320010907807	FV5	X			X	X		
TRK TANK (F/S)	19000GVW	X57545	2320010907808	FV6	X			X	X		
TRK TANK (FSA)	19000GVW	X57545	2320010907809	FV7	X			X	X		
TRK TANK (WATER)	19000GVW	X58641	2320010907810	FV8	X			X	X		
TRK TANK (FSA)	36000GVW	X57819	2320010907811	FV9	X			X	X		
TRK TANK (FSA)	44000GVW	X57956	2320010907812	FWA	X			X	X		
TRK TANK (WATER)	44000GVW	X58915	2320010907813	FWB	X			X	X		
TRK TANK (HYDROSEED)	1200GAL	X58235	2320010909530	FXB	X			X	X		
TRK TANK (ACID)	29900GVW	X57261	2320010911044	FXC	X			X	X		
TRK TANK (LIQ CHEM)	NONE	X58240	2320010911677	FW7	X			X	X		
TRK TANK (F/S)	1250 GAL	X58016	2320010911680	FXA	X			X	X		
TRK TANK (F/S)	34500GVW	X57819	2320010941371	FXV	X			X	X		
TRK TANK (FSA)	36000GVW	X57819	2320010957480	FXX	X			X	X		
TRK TANK (FISH TRANS)	35000GVW	T57329	2320012256087	FYJ	X			X	X		

**VI TRUCKS, STAKE**

TRK STAKE	NONE	NO-LIN	2320008339264	***	X			X	X		
TRK STAKE	NONE	000000	2320009260884		X			X	X		
TRK STAKE(1-1/2T-4X2)	10M GVW	X56038	2320010899165	FJA	X			X	X		
TRK STAKE (1T-4X4)	7000 GVW	X56175	2320010899166	FJB	X			X	X		
TRK STAKE(3-1/2T-4X4)	14M GVW	X56312	2320010899167	FLM	X			X	X		
TRK STAKE (1T-4X2)	7000GVW	X56038	2320010907904	FHG	X			X	X		
TRK STAKE(3-1/2T 4X2)	14000GVW	X56449	2320010907905	FLQ	X			X	X		
TRK STAKE(4-1/2T 4X2)	16000GVW	X56449	2320010907906	FLR	X			X	X		
TRK STAKE (5T 4X2)	19000GVW	X56483	2320010907907	FM8	X			X	X		
TRK STAKE(6-1/2T 4X2)	21000GVW	X56483	2320010907908	FM9	X			X	X		
TRK STAKE(4-1/2T 4X4)	19000GVW	X56312	2320010907909	FLN	X			X	X		
TRK STAKE(1-1/2T 4X4)	9000GVW	X56175	2320010907910	FH7	X			X	X		
TRK STAKE (10T 6X4)	34500GVW	X56860	2320010907911	FNB	X			X	X		

**Figure E-4. Identification of required forms for nontactical wheeled vehicles and special purpose—Continued**

ECC NOUN	MODEL	LIN	NSN	EIC	REG #	2408-4	2408-5	2408-9	2408-9	DD2026	2408-9
					REQ	WPNS REC	MWO	A/T/L/G	USAGE	USAGE	OVHL
TRK STAKE(9-1/2T 6X6)	36000GVW	X56723	2320010907912	FNA	X			X	X		
TRK STAKE (4X2)	NONE	X56466	2320010909569	FVM	X			X	X		
TRK STAKE(3-3/4T-4X4)	16000GVW	X56312	2320010957497	FLP	X			X	X		
TRK STAKE	NONE		2320010957498		X			X	X		
TRK STAKE	NONE	NO-LIN	2320012802063	***	X			X	X		
TRK STAKE (1-1/2T)	NONE		2320013027720		X			X	X		

**VJ TRUCK TRACTORS (ALL TYPES)**

TRK TCTR	NONE		2320010228438		X			X	X		
TRK TCTR (4X2)	16000GVW	X60148	2320010907779	FVH	X			X	X		
TRK TCTR (4X2)	24000GVW	X60148	2320010907780	FVJ	X			X	X		
TRK TCTR (4X2)	28000GVW	X60185	2320010907781	FVK	X			X	X		
TRK TCTR (4X2)	32000GVW	X60185	2320010907782	FVL	X			X	X		
TRK TCTR (4X4)	24000GVW	X60285	2320010907783	FVM	X			X	X		
TRK TCTR (6X4)	34500GVW	X60422	2320010907784	FVN	X			X	X		
TRK TCTR (6X4)	39500GVW	X60422	2320010907785	FVP	X			X	X		
TRK TCTR (6X4)	44500GVW	X60440	2320010907786	FVQ	X			X	X		
TRK TCTR (6X4)	51000GVW	X60440	2320010907787	FVR	X			X	X		
TRK TCTR (6X4)	64000GVW	X60440	2320010907788	FVK	X			X	X		
TRK TCTR (6X6)	36000GVW	X60559	2320010907789	FVS	X			X	X		
TRK TCTR (6X6)	44000GVW	X60559	2320010907790	FVT	X			X	X		
TRK TCTR (6X6)	51000GVW	X60577	2320010907791	FVU	X			X	X		
TRK TCTR (6X6)	60000GVW	X60577	2320010907792	FVV	X			X	X		
TRK TCTR (W/HYD 6X4)	45000GVW	X60499	2320010909526	FWF	X			X	X		
TRK TCTR (6X6-22T)	84000GVW	X60636	2320010909527	FNE	X			X	X		
TRK TCTR (6X4-15T)	NONE	X59942	2320010909528	FND	X			X	X		
TRK TCTR STLR SPOTTER	30000GVW	X59032	2320010911668	FWY	X			X	X		
TRK TCTR (W/SLEEPER)	30000GVW	X60432	2320010911669	FNZ	X			X	X		
TRK TCTR (4X2/6-8T)	NONE	X59515	2320010911670	FNC	X			X	X		
TRK TCTR (DED-6X4)	54000GVW	X58980	2320010911671	FW2	X			X	X		
TRK TCTR(CALIB 6X4)	44500GVW	X58955	2320010911672	FW3	X			X	X		
TRK TCTR (OILFIELD)	37000GVW	X59002	2320010911673	FW4	X			X	X		

**Figure E-4. Identification of required forms for nontactical wheeled vehicles and special purpose—Continued**

ECC NOUN	MODEL	LIN	NSN	EIC	REG #	2408-4	2408-5	2408-9	2408-9	DD2026	2408-9
					REQ	WPNS REC	MWO	A/T/L/G	USAGE	USAGE	OVHL
TRK TCTR (SWB)	32500GVW	X59046	2320010911674	FW5	X			X	X		
TRK TCTR (CNTNR HDL)	NONE	X60101	2320010911675	DVW	X			X	X		
TRK TCTR (SWB)	43000GVW	X59049	2320010911676	FW6	X			X	X		
TRK TCTR STLR SPOTTER	32000GVW	X59042	2320010911678	FW8	X			X	X		
TRK TCTR (DED/LWB)	44800GVW	X58978	2320010919061	FXR	X			X	X		
TRK TCTR (6X4)	44800GVW	T60508	2320011083089	FXZ	X			X	X		
TRK TCTR	NONE		2320011131483		X			X	X		
MOHV PRIME MOVER	NONE		2320012277490		X			X	X		
TRK TCTR (6X6)	77000GVW	X60440	2320012688745		X			X	X		
TRK TCTR (6X4)	52000GVW	T60576	2320013455182	B6L	X			X	X		
<b>VK BRUSHCUTTER (TRK MTD)</b>											
BRUSHCUTTER (TRK MTD)	NONE	C28863	2320010907607	FVE	X			X	X		
RECMOBILE (TRK MTD)	89NONE	R40689	2320010909329		X			X	X		
CAMPER HUT (TRK MTD)	NONE	C89598	2320010911606	FTL	X			X	X		
TRUCK ICE RESURFACE	NONE		2320011509583	FTT	X			X	X		
DOLLY TRLR CONVERTER	8T 2WHL	G34962	2330010911651	CYE	X			X	X		
DOLLY RAILWAY CONVNT	NONE	G34954	2330011050756	CYF	X			X	X		
AIRDRYER (TRLR MTD)	NONE		2330011406475	E3H	X			X	X		
DOLLY WRKR LITE VEH	NONE	D36435	2330011410831		X			X	X		
TREE CHIPPER TRLR MTD	NONE		2330012118372	C84	X			X	X		
STUMP REMVR(TCTR MTD)	NONE	U54856	2340010907608		X			X	X		
CART GOLF (EED/GED)	3-4 WHL	D13605	2340010919004		X			X	X		
UTILITY VEHICLE	4WD	NO-LIN	2340014202816	***	X			X	X		
SNOWMOBILE LIGHT DUTY	TYPE 3	T87771	2350010909325	FTX	X			X	X		
SNOW VEH CGO/PERS	TRACKED	T87736	2350010911600	FVA	X			X	X		
SNOW VEH SLOP MAINT	TRACKED	T87806	2350010911601	FVB	X			X	X		
CAR ELEC EMER EQ TRAN	1 TON	D06140	2350010911604		X			X	X		
SNOWMOBILE HEAVY DUTY	TYPE 4	T87863	2350010915163	FTY	X			X	X		
SLED SP SNOWMOBILE	MOST	S70543	2350013558122	A2A	X			X	X		
TCTR WHLD LAWN	GED14HP	W88960	2420010911598		X			X	X		
TCTR WHLD LAWN	GED12HP	W88950	2420010911599		X			X	X		

Figure E-4. Identification of required forms for nontactical wheeled vehicles and special purpose—Continued

ECC NOUN	MODEL	LIN	NSN	EIC	REG #	2408-4	2408-5	2408-9	2408-9	DD2026	2408-9
					REQ	WPNS REC	MWO	A/T/L/G	USAGE	USAGE	OVHL
TRUCK CARGO 1-1/4T	M883	X39450	2320005798959	BDF	X			X	X		X
TRUCK CARGO 1-1/4T	M884	X39453	2320005798985	BDG	X			X	X		X
TRUCK CARGO 1-1/4T	M885	X39441	2320005798989	BDH	X			X	X		X
TRUCK CARGO 1-1/4T	M890	X39429	2320005798991	BDJ	X			X	X		X
TRUCK CARGO 1-1/4T	M892	X39435	2320005799052	BDL	X			X	X		X
TRUCK CARGO 1-1/4T	M561	X39940	2320008735407	BFB	X			X	X	X	X
TRUCK CARGO 1-1/4T	M715	X39883	2320009216365	BFD	X			X	X		X
TRUCK CARGO 1-1/4T	M715 W/W	X39906	2320009216366	BFF	X			X	X		X
TRUCK MAINT 1-1/4T	M726	X53775	2320009216833	BFG	X			X	X		X
TRK MAINT TEL 1-1/4T	M888	T53498	2320010440333	BDM	X			X	X		X
TRUCK UTILITY 1-1/4T	M966	T05096	2320011077153	BBC	X		X	X	X		X
TRUCK UTILITY 1-1/4T	M998	T61494	2320011077155	BBD	X		X	X	X		X
TRUCK UTILITY 1-1/4T	M1038	T61562	2320011077156	BBE	X		X	X	X		X
TRUCK CARGO 1-1/4T	M1008A1	T59346	2320011232671	BEC	X			X	X		X
TRUCK CARGO 1-1/4T	M1008WE	T59482	2320011236827	BED	X			X	X		X
TRUCK CARGO 1-1/4T	M1028	T59414	2320011275077	BEE	X		X	X	X		X
TRUCK UTILITY 1-1/4T	M1025	T92242	2320011289551	BBF	X		X	X	X		X
TRUCK UTILITY 1-1/4T	M1026	T92310	2320011289552	BBG	X		X	X	X		X
TRUCK UTILITY 1-1/4T	M1031		2320011335368	BBL	X			X	X		X
TRUCK UTILITY 1-1/4T	M1042		2320011467187		X		X	X	X		X
TRUCK UTILITY 1-1/4T	M1046	NO-LIN	2320011467188	***	X			X	X		X
TRUCK UTILITY 1-1/4T	M1043		2320011467190		X		X	X	X		X
TRUCK UTILITY 1-1/4T	XM1055		2320011467192		X			X	X		X
TRUCK UTILITY 1-1/4T	M1037	T07543	2320011467193	BBK	X		X	X	X		X
TRUCK UTILITY 1-1/4T	XM1054		2320011481638		X			X	X		X
TRUCK UTILITY 1-1/4T	XM1056		2320011481639		X			X	X		X
TRUCK UTILITY 1-1/4T	XM1053		2320011501035		X			X	X		X
TRUCK CARGO 1-1/4T	M1028A1	T59550	2320011580820	BEF	X		X	X	X		X
TRUCK UTILITY 1-1/4T	M1069	T07611	2320012340497	BBJ	X			X	X		X
TRUCK CARGO 1-1/4T	NONE		2320012950822		X			X	X		X
TRK CGO DUAL REAR WHL	M1028A3	Z40435	2320013251937		X		X	X	X		X
TRUCK UTILITY 1-1/4T	M1097	T07679	2320013469317	BBM	X		X	X	X		X
TRUCK UTILITY 1-1/4T	M998A1	T61494	2320013719577	BBN	X		X	X	X		X

Figure E-4. Identification of required forms for nontactical wheeled vehicles and special purpose—Continued

ECC NOUN	MODEL	LIN	NSN	EIC	REG #	2408-4	2408-5	2408-9	2408-9	DD2026	2408-9
					REQ	WPNS REC	MWO	A/T/L/G	USAGE	USAGE	OVHL
BUS MTR (FCS)	37 PAX	C39833	2310010907691	FDE	X			X	X		
BUS MTR (SCHOOL)	20 PAX	C39696	2310010907692	FDJ	X			X	X		
BUS MTR (SCHOOL)	29 PAX	C39985	2310010907693	FDL	X			X	X		
BUS MTR (SCHOOL)	37 PAX	C39985	2310010907694	FDM	X			X	X		
BUS MTR (SCHOOL)	20 PAX	C39696	2310010907695	FDH	X			X	X		
BUS MTR (FCS)	25 PAX	C39696	2310010907696	FDJ	X			X	X		
BUS MTR (FCA)	25 PAX	C39696	2310010907697	FDK	X			X	X		
BUS MTR (ADULT)	36 PAX	C39985	2310010907698	FDN	X			X	X		
BUS MTR (ADULT)	44 PAX	C39985	2310010907699	FDP	X			X	X		
BUS MTR (SCHOOL)	60 PAX	C39985	2310010907700	FDQ	X			X	X		
BUS MTR (SUB)	45 PAX	C39970	2310010907701	FDR	X			X	X		
BUS MTR (SUB)	53 PAX	C39970	2310010907702	FDS	X			X	X		
BUS MTR (SUB)	53 PAX	C39970	2310010907703	FDT	X			X	X		
BUS MTR (INCY)	41 PAX	C39970	2310010907704	FDU	X			X	X		
BUS MTR (CONV)	12 PAX	C39559	2310010907705	FDV	X			X	X		
BUS MTR (TRANSIT)	28 PAX	C39977	2310010907707	FDY	X			X	X		
BUS MTR (TRANSIT)	36 PAX	C39977	2310010907708	FDZ	X			X	X		
BUS MTR (TRANSIT)	44 PAX	C39977	2310010907709	FD2	X			X	X		
BUS MTR (SCHOOL)	66 PAX	C39836	2310010907710	FD4	X			X	X		
BUS MTR (AMB)	82 PAX	C40045	2310010907711	FDG	X			X	X		
AUTO SEDAN(S-COMPACT)	CLASS IB	B04725	2310010907738	FCL	X			X	X		
AUTO SEDAN (COMPACT)	CLASS II	B04441	2310010907739	FCG	X			X	X		
AUTO SEDAN (MID-SIZE)	CLASS 3	B04715	2310010907740	FCJ	X			X	X		
AUTO SEDAN (LARGE)	CLASS IV	B04720	2310010907741	FCK	X			X	X		
TRK AMB (PAT TRANS)	4X2	X38365	2310010907829	FFA	X			X	X		
TRK AMB (FIELD TYPE)	4X4	X38502	2310010907830	FFH	X			X	X		
AUTO S/W (MID-SIZE)	CLASS 3	B04852	2310010907877	FCN	X			X	X		
AUTO S/W (LARGE)	CLASS IV	B04862	2310010907878	FCP	X			X	X		
AUTO S/W (S-COMPACT)	CLASS IB	B04872	2310010907879	FCQ	X			X	X		
BUS MTR (VAN)	12 PAX	C39559	2310010910996	FDV	X			X	X		
AUTO S/W (COMPACT)	CLASS II	B04832	2310010911060	FCM	X			X	X		
TRK AMB EMERG MED SVC	4X4	X54765	2310010911684	FFG	X			X	X		
BUS AMB	28 PAX	B39319	2310010924041	FD5	X			X	X		

Figure E-4. Identification of required forms for nontactical wheeled vehicles and special purpose—Continued

ECC NOUN	MODEL	LIN	NSN	EIC	REG #	2408-4	2408-5	2408-9	2408-9	DD2026	2408-9
					REQ	WPNS REC	MWO	A/T/L/G	USAGE	USAGE	OVHL
BUS AMB (CONV)	44 PAX	B39319	2310010924042	FD6	X			X	X		
AUTO AMB (METRO)	4L 4X2	B04304	2310010941363		X			X	X		
AUTO AMB (METRO)	2L 4X2	B04294	2310010941364		X			X	X		
AUTO AMB (HEARSE)	1L 4X2	B04294	2310010941365	FFC	X			X	X		
TRK AMB EMERG MED SVC	4X2	X38464	2310010941372	FFD	X			X	X		
BUS MTR (AMB CONV)	66 PAX	C39836	2310010957447	FD3	X			X	X		
BUS MTR (VAN)	16 PAX	C39559	2310011015060	FDX	X			X	X		
TRK AMB	NONE		2310011294702		X			X	X		
AUTO SEDAN (LARGE)	MODIFIED	A04646	2310011350996	FCA	X			X	X		
AUTO SEDAN (MID-SIZE)	MODIFIED	A04714	2310011350997	FCB	X			X	X		
AUTO S/W (COMPACT)	MOD		2310011361178	FCF	X			X	X		
AUTO S/W (MIDSIZE)	MOD		2310011384853	FCD	X			X	X		
AUTO SEDAN (COMPACT)	MODIFIED	A06970	2310011406537	FCE	X			X	X		
AUTO SEDAN	MOD		2310011408229	FCC	X			X	X		
TRK AMB EMERG MED SVC	4X2 MOD	X38464	2310011706843	FFE	X			X	X		
TRK AMB EMERG MED SVC	4X4 MOD	X54765	2310011714747	FFF	X			X	X		
CARRIER ALL TERRIN	2 PAX	D10915	2320010910931	FWN	X			X	X		
TRK WHSE (PERS)	4 PAX	X54976	2320010911592	DC7	X			X	X		
MTRCYCLE CHAIN DRIVE	NONE	M72933	2340010907748	B8B	X			X	X		
MTRCYCLE CONV DRIVE	NONE	M72933	2340010907749	B8C	X			X	X		
MTRCYCLE W/SIDE CAR	NONE	M72933	2340010907750	B8D	X			X	X		
SCOOTER MOTOR (GAS)	2 WHL	S55256	2340010907875	B8E	X			X	X		
SCOOTER MOTOR (ELECT)	3 WHL	S55256	2340010907876	B8F	X			X	X		
MTRCYCLE TRAIL BIKE	NONE	M72633	2340010911658	B8H	X			X	X		
SCOOTER W/CAB	3 WHL	S55266	2340010911715	B8J	X			X	X		
SCOOTER MOTOR (GED)	3 WHL	S55261	2340010911716	B8L	X			X	X		
SCOOTER MOTOR (ELECT)	4 WHL	S55334	2340010913396	B8M	X			X	X		
SCOOTER MOTOR (GAS)	3 WHL	S55256	2340010941374	B8G	X			X	X		
SCOOTER MOTOR (FB)	4 WHL	S55334	2340010957490	B8N	X			X	X		
SCOOTER VAN (GAS)	4 WHL	S55334	2340010957491	B8P	X			X	X		
SCOOTER MOTOR	3 WHL	S55261	2340010969342	B8K	X			X	X		

Figure E-4. Identification of required forms for nontactical wheeled vehicles and special purpose—Continued



ECC NOUN	MODEL	LIN	NSN	EIC	REG #	2408-4	2408-5	2408-9	2408-9	DD2026	2408-9
					REQ	WPNS REC	MWO	A/T/L/G	USAGE	USAGE	OVHL
<b>VM SERVICING PLATFORMS</b>											
SVC PLTFM (TRK MTD)	CL-C/4X4	S80070	2320000064066	FSL	X			X	X		X
SVC PLTFM (TRK MTD)	1900GVW	S80048	2320004199539	FSK	X			X	X		
SVC PLTFM (TRK MTD)	NONE	S80088	2320004900857	FSP	X			X	X		
SVC PLTFM (TRK MTD)	CL-B/4X2	S80068	2320004900858	FSQ	X			X	X		
SVC PLTFM (TRK MTD)	CL-A/4X2	S80048	2320004900860	FSR	X			X	X		
SVC PLTFM (TRK MTD)	6X4	S80078	2320004939179	FSM	X			X	X		
SVC PLTFM (TRK MTD)	30 FT	S80108	2320009357267	FSS	X			X	X		
SVC PLTFM (SP)	NONE	S79882	4940010909327	C88	X			X	X		
SVC PLTFM LIFT SCISS	NONE		4940010969358	FST	X			X	X		
<b>VN TRUCKS, MULTIPURPOSE</b>											
TRK MULTI-PURP	4T-4X4	X54514	2320010909330	FLF	X			X	X		
TRK MULTI-PURP	2T-4X4	X54498	2320010911605	FKG	X			X	X		
TRK MULTI-PURP UNIMOG	2T-4X4	X54498	2320011479914	FKF	X			X	X		
TRK MULTI-PURP UNIMOG	4T-4X4	X54514	2320011479915	FLG	X			X	X		
<b>VO TRUCKS, PANEL</b>											
TRK PANEL (1/2T-4X2)	4700GVW	X54805	2320010907837	FHV	X			X	X		
TRK PANEL (3/4T-4X2)	6010GVW	X54805	2320010907838	FHW	X			X	X		
TRK PANEL (1T-4X2)	8510GVW	X54825	2320010907839	FH2	X			X	X		
TRK PANEL (1T-4X2)	6400GVW	X54805	2320010907840	FHX	X			X	X		
TRK PANEL (POLICE)	6000GVW	X54775	2320010907841	FHZ	X			X	X		
TRK PANEL (1/4T-4X4)	5000GVW	X54942	2320010907843	FH4	X			X	X		
TRK PANEL(1-1/2T-4X4)	9000GVW	X54966	2320010907844	FJF	X			X	X		
TRK PANEL (1/4T-4X4)	5000GVW	X54942	2320010911045	FH3	X			X	X		
TRK PNL MOBILE DISPLY	8500GVW	X54770	2320010911685	FXG	X			X	X		
TRK PNL (TV PROD)	4X2	X54970	2320010911686	FXH	X			X	X		
TRK PANEL	NONE		2320011654717		X			X	X		X
TRK PANEL (VW)	2360KG	X54805	2320121943836	FHY	X			X	X		

Figure E-4. Identification of required forms for nontactical wheeled vehicles and special purpose—Continued

ECC NOUN	MODEL	LIN	NSN	EIC	REG #	2408-4	2408-5	2408-9	2408-9	DD2026	2408-9
					REQ	WPNS REC	MWO	A/T/L/G	USAGE	USAGE	OVHL
<b>VP TRUCKS, CARRYALL</b>											
TRK CARRYALL	NONE	NO-LIN	2320005423158	***	X			X	X		
TRK CA (1/2T-4X2)	4500GVW	X42064	2320010907831	FG4	X			X	X		
TRK CA (3/4T-4X2)	6000GVW	X42064	2320010907832	FG5	X			X	X		
TRK CA (1T-4X2)	7400GVW	X42064	2320010907833	FG6	X			X	X		
TRK CA (1-1/2T-4X2)	8500GVW	X42064	2320010907834	FG7	X			X	X		
TRK CA (1/2T-4X4)	6100GVW	X42201	2320010907835	FG8	X			X	X		
TRK CA (1-1/4T-4X4)	8550GVW	X42201	2320010907836	FG9	X			X	X		
TRK MULTISTOP DEL	6500GVW	X54531	2320010907898	FHT	X			X	X		
TRK MULTISTOP DEL	7000GVW	X54531	2320010907899	FHU	X			X	X		
TRK MULTISTOP DEL	14000GVW	X54549	2320010907900	FMZ	X			X	X		
TRK MULTISTOP DEL	21000GVW	X54549	2320010907901	FM2	X			X	X		
TRK MSD (BKMOBL CONV)	5T	X54549	2320010907902	FM3	X			X	X		
TRK CA (1-1/4T-4X2)	8500GVW	T41903	2320010953211	FGB	X			X	X		
TRK CARRYALL (MOD)	4X2	T42132	2320011351018	FX7	X			X	X		
TRK CARRYALL (MOD)	4X4	T42200	2320011361168	FYA	X			X	X		
TRK CARRYALL	NONE	NO-LIN	2320011654716	***	X			X	X		
TRK CA (KIT RDY)	4X2	T63405	2320012378167		X			X	X		X
TRK CA (KIT RDY)	4X4	T63301	2320012391788		X			X	X		X
TRK CA (1/2T-4X2)	NONE	T42269	2320121943837	FGC	X			X	X		
<b>VQ TRUCKS, CARGO</b>											
TRK CARGO (COMPACT)	NONE	T39642	2320010907880	FGP	X			X	X		
TRK CARGO (1/2T-4X2)	4500GVW	X39598	2320010907881	FGK	X			X	X		
TRK CARGO (1/2T-4X2)	4800GVW	X39598	2320010907882	FGL	X			X	X		
TRK CARGO (3/4T-4X2)	6300GVW	X39598	2320010907883	FGS	X			X	X		
TRK CARGO (1T-4X2)	10000GVW	X39877	2320010907884	FGT	X			X	X		
TRK CARGO (3/4T-4X2)	8510GVW	X39598	2320010907885	FGM	X			X	X		
TRK CARGO (6T-4X2)	19000GVW	X41516	2320010907886	FMD	X			X	X		
TRK CARGO(6-1/2T-4X2)	21000GVW	X41516	2320010907887	FME	X			X	X		
TRK CARGO(7-1/2T-4X2)	24000GVW	X41516	2320010907888	FMF	X			X	X		

Figure E-4. Identification of required forms for nontactical wheeled vehicles and special purpose—Continued

ECC NOUN	MODEL	LIN	NSN	EIC	REG # REQ	2408-4 WPNS REC	2408-5 MWO	2408-9 A/T/L/G	2408-9 USAGE	DD2026 USAGE	2408-9 OVHL
TRK CARGO(1 1/4T-4X4)	COMPACT	X39461	2320010907889	FGH	X			X	X		
TRK CARGO(1 1/4T-4X4)	COMPACT	X39461	2320010907890	FGJ	X			X	X		
TRK CARGO(1/2T-4X4)	6000GVW	X39893	2320010907891	FGW	X			X	X		
TRK CARGO(3/4T-4X4)	6600GVW	X39893	2320010907892	FGX	X			X	X		
TRK CARGO(1T-4X4)	8510GVW	X39893	2320010907893	FGY	X			X	X		
TRK CARGO(1T-4X4)	10000GVW	X39893	2320010907894	FGZ	X			X	X		
TRK CARGO(3/4T-4X4)	8000GVW	X39893	2320010907895	FG2	X			X	X		
TRK CARGO(1T-4X4)	10000GVW	X39893	2320010907896	FG3	X			X	X		
TRK CARGO(7T-4X4)	24000GVW	X41379	2320010907897	FMC	X			X	X		
TRK CARGO(1T-4X4)	NONE	X39879	2320010909562	FGU	X			X	X		
TRK CARGO(1/2T-4X4)	NONE	X39656	2320010909563	FGQ	X			X	X		
TRK CARGO(5T-4X4)	19000GVW	X41379	2320010911061	FMB	X			X	X		
TRK CARGO(1T-4X4)	4-DOOR	X39880	2320010911722	FGV	X			X	X		
TRK CARGO(1T-4X2)	4-DOOR	X39875	2320010911723	FGR	X			X	X		
TRK CARGO(2-1/2T-4X2)	4-DOOR	X39976	2320010919072	FKA	X			X	X		
TRK CARGO(MOD)	4X4	T40008	2320011351021	FX8	X			X	X		
TRK CARGO(MOD)	4X2	T39940	2320011361179	FYB	X			X	X		
TRK ACFT CGO LOADING	DED/GED	X38355	3920010970301	DVS	X			X	X		
<b>VR TRUCKS, UTILITY</b>											
TRK UTIL(1/2T-4X2)	3200GVW	X61518	2320010907826	FJC	X			X	X		
TRK UTIL(WAGON-4X2)	3200GVW	X61518	2320010907827	FJD	X			X	X		
TRK UTIL(1/2T-4X4)	3500GVW	X61655	2320010907828	FJE	X			X	X		
TRK UTIL(FORESTRY)	4X4	B04892	2320010909534	FWK	X			X	X		
TRK UTIL(W/ROPS)	4X4	T04960	2320010915395	FGA	X			X	X		
TRK UTIL(4X4)	3900GVW	X61705	2320010919063	FXT	X			X	X		
TRK UTIL(MOD)	4X2	T61038	2320011351016	FX5	X			X	X		
TRK UTIL(MOD)	4X4	T61106	2320011351017	FX6	X			X	X		
TRK UTIL(KIT RDY)	4X4	T91660	2320012378165		X			X	X		
TRK UTIL(4X4)	VLC2	T07747	2320014323985		X			X	X		
TRUCK UTILITY	CHEVY	NO-LIN	232011167730	***	X			X	X		

Figure E-4. Identification of required forms for nontactical wheeled vehicles and special purpose—Continued

ECC NOUN	MODEL	LIN	NSN	EIC	REG # REQ	2408-4 WPNS REC	2408-5 MWO	2408-9 A/T/L/G	2408-9 USAGE	DD2026 USAGE	2408-9 OVHL
<b>VS TRUCKS, SEWAGE</b>											
TRK TANK(SEPTIC)	4X4	X58245	2320010909531	FWG	X			X	X		
TRK TNK SLUDGE DISP	NONE	X58250	2320010911679	FW9	X			X	X		
TRK TNK SLUDGE DISP	NONE	X58250	2320011361167	FX9	X			X	X		
<b>VT TRUCKS, OTHER</b>											
TRK FB W/HYD LIF BOOM	5T	X45200	2320010909559	FLB	X			X	X		
TRK FB(EQUIP TRANS)	44500GVW	X45176	2320010909560		X			X	X		
TRK FB(EQUIP TRANS)	21000GVW	X45175	2320010909561	FWL	X			X	X		
TRK MOBILE SRAGE	4X4	X54453	2320010911593	FVP	X			X	X		
TRK FOOD(CART TWD)	3X2	X45299	2320010911594	FWQ	X			X	X		
TRK RESCUE	1T-4X4	X55874	2320010911597	FH5	X			X	X		
BLOWER(TRK MTD)	NONE	B81960	2320010911603	FRA	X			X	X		
MOB EQ TRANS(TRK MTD)	NONE	M57470	2320010911607	FWR	X			X	X		
TRK FB(RIGGER MAINT)	4X2	X45177	2320010911717	FXJ	X			X	X		
TRK FB(BOMB SVC)	4X4	X45165	2320010911718	FKB	X			X	X		
TRK FB(EQUIP TRANS)	4X2	T45243	2320010911719	FKX	X			X	X		
TRK FB W/AERIAL PLTFM	8X8	X45210	2320010911720	FXL	X			X	X		
TRK FB	1T-4X2	X45163	2320010911721	FHA	X			X	X		
BOOKMOBILE(TRK MTD)	NONE	C02572	2320010915164		X			X	X		
TRK(ARMED PAYROLL)	NONE	T39026	2320011134669	FX2	X			X	X		
TRK FB(TILT)	50000GVW	X45176	2320012091656	FYH	X			X	X		
TRK(HAZARDOUS MAT)	PUMPER	X62273	2320014225405		X			X	X		
TRK FORKLIFT(GED)	30000 LB	X52804	3930010907713	DPQ	X			X	X		
TRK FORKLIFT(GAS)	6000 LBS	X52814	3930010907714	DPR	X			X	X		
TRK FORKLIFT(ELECT)	4000 LBS	X50462	3930010907715	DCD	X			X	X		
TRK FORKLIFT(DED/GED)	7000 LBS	X52647	3930010907716	DPS	X			X	X		
TRK FORKLIFT(ELECT)	NONE	X49737	3930010907717	DCE	X			X	X		
TRK FORKLIFT(ELECT)	2500 LBS	X49603	3930010907718	DCF	X			X	X		
TRK FORKLIFT(ELECT)	2000 LBS	X49288	3930010907719	DCG	X			X	X		
TRK FORKLIFT(ELECT)	4000 LBS	X50608	3930010907720	DCH	X			X	X		

Figure E-4. Identification of required forms for nontactical wheeled vehicles and special purpose—Continued

ECC NOUN	MODEL	LIN	NSN	EIC	REG # REQ	2408-4 WPNS REC	2408-5 MWO	2408-9 A/T/L/G	2408-9 USAGE	DD2026 USAGE	2408-9 OVHL
TRK FORKLIFT (ELECT)	4000 LBS	X50638	3930010907721	DCJ	X			X	X		
TRK FORKLIFT (LP/GD)	5000 LBS	X52812	3930010907722	DPT	X			X	X		
TRK FORKLIFT (ELECT)	3000 LBS	X49757	3930010907723	DCK	X			X	X		
TRK FORKLIFT (ELECT)	5000 LBS	X48873	3930010907724	DXC	X			X	X		
TRK FORKLIFT(GAS/DED)	20000 LB	X52816	3930010907725	DPU	X			X	X		
TRK FORKLIFT (ELECT)	1500 LBS		3930010907726	DCL	X			X	X		
TRK FORKLIFT (ELECT)	4000 LBS	X51020	3930010907727	DCM	X			X	X		
TRK FORKLIFT (DED)	6000 LBS	X48876	3930010907728	DXD	X			X	X		
TRK FORKLIFT (ELECT)	4000 LBS	X51011	3930010907729	DCN	X			X	X		
TRK FL PLTFM (ELECT)	4000 LBS	X53171	3930010907731	DCP	X			X	X		
TRK FORKLIFT(DED/GED)	NONE	X52813	3930010911654	DPV	X			X	X		
TRK FL (ROUGH TERRIN)	6000 LBS	X52852	3930010911655	DJ4	X			X	X		
TRK STOCK SELECTOR	EED SRT	T56996	3930010917614	DCS	X			X	X		
TRK FORKLIFT (DED)	27500LBS	X48880	3930010957448	DXE	X			X	X		
TRK FL (NARROW AISLE)	3000 LBS	T48982	3930011028293	DCU	X			X	X		
TRK FORKLIFT (ELECT)	6000 LBS	X50294	3930011028383	DCV	X			X	X		
TRK FORKLIFT (ELECT)	6000 LBS	X50866	3930011028384	DCW	X			X	X		
TRK LF STK SEL (ELEC)	2500 LBS	X49609	3930011075722	DCX	X			X	X		
TRK FL STK SEL (ELEC)	2500 LBS	X49619	3930011075723	DCY	X			X	X		
TRK FORKLIFT (ELECT)	25000 LBS	NO-LIN	3930011094840	DCZ	X			X	X		
TRK FORKLIFT (ELECT)	3 WHL	X48830	3930011122284	DC2	X			X	X		
TRK FORKLIFT (DED)	4000 LBS	X48863	3930011122285	DXF	X			X	X		
CRANE TRK WHSE	4-6T	C39035	3950010907733	DC6	X			X	X		
PLTFM LIFT SP/WHL MTD	NONE	P05782	4940011050760	FSF	X			X	X		
PLTFM LIFT SP/WHL MTD	NONE	P05757	4940011050764	FSD	X			X	X		
PLTFM LIFT (AIR ACT)	NONE		4940011050765	FSE	X			X	X		
<b>VU TRAILERS</b>											
TRLR VAN (OFFICE)	2 WHL	W99058	2330010907869	C8M	X			X	X		
TRLR VAN (OFFICE)	4 WHL	W99058	2330010907870	C8N	X			X	X		
TRLR TANK (WATER)	400G	W98962	2330010907871	C6J	X			X	X		
TRLR TANK (ASPHALT)	NONE		2330010907872	C6A	X			X	X		

Figure E-4. Identification of required forms for nontactical wheeled vehicles and special purpose—Continued

ECC NOUN	MODEL	LIN	NSN	EIC	REG # REQ	2408-4 WPNS REC	2408-5 MWO	2408-9 A/T/L/G	2408-9 USAGE	DD2026 USAGE	2408-9 OVHL
TRLR (LOW BED-TILT)	10T-4WHL	W97318	2330010907873	CAC	X			X	X		
TRLR (LOW BED-TILT)	6T-2 WHL	W97318	2330010907874	CAD	X			X	X		
TRLR SRAKE (2 1/2T)	4 WHL	W98688	2330010907916	CMH	X			X	X		
TRLR (HOUSE)	2 WHL	W97010	2330010907927	C85	X			X	X		
TRLR (HOUSE)	4 WHL	W97010	2330010907928	C86	X			X	X		
TRLR CAMPER HUT TYPE	4-6SLEEP	W95273	2330010909323		X			X	X		
TRLR (MOBILE STAGE)	4 WHL	W97739	2330010909324		X			X	X		
TRLR (CABLE SPICER)	2 WHL	W95272	2330010909326	C87	X			X	X		
TRLR (TURRET TRANS)	NONE	W92962	2330010909328	C89	X			X	X		
TRLR CGO UTIL MAINT	NONE	W95346	2330010909538	CBA	X			X	X		
TRLR VAN	2-HORSE	W99025	2330010909541	C8G	X			X	X		
TRLR CHASSIS RECRUIT	NONE	E03104	2330010909542	C8T	X			X	X		
TRLR VAN	4-HORSE	W99026	2330010909543	C8H	X			X	X		
TRLR VAN-AIR MONITOR	NONE	W99016	2330010909544	C8B	X			X	X		
TRLR VAN	4 WHL	W99012	2330010909545	C8A	X			X	X		
TRLR TANK	200G	W98690	2330010909546	C6C	X			X	X		
TRLR (LOW BED)	3000 LBS	W97381	2330010909547	CEM	X			X	X		
TRLR MAINT(TOOL STOR)	2 WHL	W97734	2330010909573	C8U	X			X	X		
TRLR MAINT(TOOL SHED)	4-6 WHL	W97736	2330010909574	C8V	X			X	X		
TRLR MOBILE HOME	60 FT	W97027	2330010909579	C9A	X			X	X		
TRLR CGO W/ELEV BODY	NONE	W95801	2330010911048	CEL	X			X	X		
TRLR VAN (10-HORSE)	NONE	W99030	2330010911049	C8K	X			X	X		
TRLR TANK (FUEL)	500 GAL	W98698	2330010911050	C6D	X			X	X		
TRLR (OIL FILTER-DRY)	NONE	W93693	2330010911596	C8Y	X			X	X		
TRLR CAMPER HOME TYPE	20FT	W95283	2330010911602		X			X	X		
TRLR CARGO	5T-4 WHL	W96004	2330010911693	CPJ	X			X	X		
TRLR VAN (AMMO-43FT)	4 WHL	W99020	2330010911700	C8C	X			X	X		
TRLR VAN (TOOL CRIB)	4 WHL	W99383	2330010911701	C8S	X			X	X		
TRLR VAN (SPARE PTS)	4 WHL	W99022	2330010911702	C8E	X			X	X		
TRLR VAN INF MUSEUM	NONE	W99044	2330010911703	C8L	X			X	X		
TRLR VAN (EXPER CTR)	NONE	W99023	2330010911704	C8F	X			X	X		
TRLR VAN ADP FACILITY	NONE	W99109	2330010911705	C8Q	X			X	X		
TRLR TNK-SEWAGE DISP	IND	W98708	2330010911706	C6E	X			X	X		

Figure E-4. Identification of required forms for nontactical wheeled vehicles and special purpose—Continued

ECC NOUN	MODEL	LIN	NSN	EIC	REG # REQ	2408-4 WPNS REC	2408-5 MWO	2408-9 A/T/L/G	2408-9 USAGE	DD2026 USAGE	2408-9 OVHL
TRLR TANK (OIL)	400 GAL	W98758	2330010911707	C6G	X			X	X		
TRLR TANK (FUEL CALB)	100 GAL	W98689	2330010911708	C6B	X			X	X		
TRLR (LOW BED-TILT)	4 WHL	W97308	2330010911709	CNM	X			X	X		
TRLR (LOW BED)	8T-4WHL	W97445	2330010911710	CKA	X			X	X		
TRLR (LOW BED)	4T-2WHL	W97450	2330010911712	CNL	X			X	X		
TRLR (LB, W RAMP-19T)	NONE	W97468	2330010911713	CZC	X			X	X		
TRLR (LB-TILT/1-3T)	2WHL	W97244	2330010911714	CMJ	X			X	X		
TRLR (FB-TILT-1-3T)	6 WHL	W96691	2330010911727	CNK	X			X	X		
TRLR (FLAT BED)	15T-6WHL	W96917	2330010911728	CZB	X			X	X		
TRLR (FLAT BED)	6T-4WHL	W96711	2330010911729	CPH	X			X	X		
TRLR (LB-TILT-1-3T)	NONE	W97276	2330010911730	CEN	X			X	X		
TRLR BOL POLE HAUL	3T	W94568	2330010911732	CNJ	X			X	X		
TRLR (CABLE REEL)	6T-2WHL	W95270	2330010911733	CPE	X			X	X		
TRLR CAMPER HUT TYPE	4-6SLEEP	W95293	2330010919005		X			X	X		
TRLR VAN	6-HORSE	W99027	2330010919066	C8J	X			X	X		
TRLR VAN (RECRUITING)	NONE	W99378	2330010919067	C8R	X			X	X		
TRLR (LOW BED)	9T	W97460	2330010919068	CAF	X			X	X		
TRLR (LOW BED)	12T-4WHL	W97465	2330010919069	CZA	X			X	X		
TRLR (LOW BED-4-6T)	4 WHL	W97452	2330010919070	CNN	X			X	X		
TRLR (FLAT BED-9-12T)	4-6 WHL		2330010977081		X			X	X		
TRLR (FLAT BED-TILT)	20T-4WHL	W96982	2330011023544	CZD	X			X	X		
TRLR VAN (FLD OFC)	2-4 WHL	T99091	2330011062223	C8P	X			X	X		
TRLR TANK (FUEL)	250 GAL	T98757	2330011162960	C6F	X			X	X		
TRLR TANK (SEWAGE)	NONE		2330011162961	C6H	X			X	X		
TRLR (SNOWMOBILE)	NONE	T25601	2330011321386		X			X	X		
TRLR (LOW BED-TILT)	4WHL-6T	W97318	2330011473339	CAE	X			X	X		
TRLR MOBILE STAGE	6 WHL	W97749	3920011113969	DVX	X			X	X		
<b>VV SEMI-TRAILERS</b>											
SEMITRLR (STRADDLE)	NONE		2330004195742		X			X	X		
STRRLR VAN	NONE		2330008924845		X			X	X		
SEMITRLR VAN (DRY)	NONE		2330009416859		X			X	X		

Figure E-4. Identification of required forms for nontactical wheeled vehicles and special purpose—Continued

ECC NOUN	MODEL	LIN	NSN	EIC	REG # REQ	2408-4 WPNS REC	2408-5 MWO	2408-9 A/T/L/G	2408-9 USAGE	DD2026 USAGE	2408-9 OVHL
STRRLR (REFUSE COLL)	75 CU-YD	S71690	2330010236047	C4U	X			X	X		
STRRLR (REFRIG-7T)	2 WHL	S71476	2330010907765	CWK	X			X	X		
STRRLR (REFRIG-12T)	2 WHL	S71476	2330010907766	CWJ	X			X	X		
STRRLR (REFRIG-20T)	4 WHL	S71630	2330010907767	CWL	X			X	X		
STRRLR VAN CGO (FURN)	2WHL-12T	S73942	2330010907845	CWR	X			X	X		
STRRLR VAN (PERS-7T)	80 PASS	S74901	2330010907846	CQD	X			X	X		
STRRLR VAN CGO(CLOSED)	2WHL-12T	S73942	2330010907847	CWS	X			X	X		
STRRLR VAN CARGO (20T)	4 WHL	S74096	2330010907848	CWV	X			X	X		
STRRLR VAN CGO (OPEN)	2WHL-12T	S73942	2330010907849	CWU	X			X	X		
STRRLR TANK (F/S)	2000 GAL	S72709	2330010907850	C4L	X			X	X		
STRRLR TANK (F/S)	2000 GAL	S72709	2330010907851	C4M	X			X	X		
STRRLR TANK (F/S)	3000 GAL	S72709	2330010907852	C4N	X			X	X		
STRRLR TANK (WATER)	4000 GAL	S73257	2330010907853	C4P	X			X	X		
STRRLR TANK (F/S)	4000 GAL	S72726	2330010907854	C4F	X			X	X		
STRRLR TANK (WATER)	5000 GAL	S73257	2330010907855	C4Q	X			X	X		
STRRLR TANK (F/S)	5000 GAL	S72726	2330010907856	C4G	X			X	X		
STRRLR TANK (F/S)	6000 GAL	S72726	2330010907857	C4H	X			X	X		
STRRLR TANK (F/S)	5500 GAL	S72726	2330010907858	C4J	X			X	X		
STRRLR TANK (WATER)	5500 GAL	S73257	2330010907859	C4R	X			X	X		
STRRLR (LOW BED)	15T-4WHL	S70380	2330010907860	CXB	X			X	X		
STRRLR (LOW BED)	20T-4WHL	S70380	2330010907861	CXC	X			X	X		
STRRLR (LOW BED)	25T-4WHL	S70380	2330010907862	CXD	X			X	X		
STRRLR (LB-LEVEL DECK)	35T-4WHL	S70534	2330010907863	CXE	X			X	X		
STRRLR (LB-LEVEL DECK)	35T-4WHL	S70534	2330010907864	CXG	X			X	X		
STRRLR (LB-TILT DECK)	30T-4WHL	S70534	2330010907865	CXH	X			X	X		
STRRLR LOW-BED	60T 8WHL	S70825	2330010907866	CXN	X			X	X		
STRRLR (LB-HYDR LF)	12T-2WHL	S70669	2330010907867	CWH	X			X	X		
STRRLR STAKE	12T-2WHL	S72161	2330010907917	CWM	X			X	X		
STRRLR STAKE	12T-2WHL	S72161	2330010907918	CWN	X			X	X		
STRRLR STAKE	20T-4WHL	S72178	2330010907919	CWQ	X			X	X		
STRRLR STAKE	12T-2WHL	S72161	2330010907920	CWP	X			X	X		
STRRLR VAN	SHOP 12	S75000	2330010909535	CWX	X			X	X		
STRRLR VAN (HORSE)	25 CAP	S74550	2330010909536	C4C	X			X	X		

Figure E-4. Identification of required forms for nontactical wheeled vehicles and special purpose—Continued

ECC NOUN	MODEL	LIN	NSN	EIC	REG # REQ	2408-4 WPNS REC	2408-5 MWO	2408-9 A/T/L/G	2408-9 USAGE	DD2026 USAGE	2408-9 OVHL
STRLR VAN (MSL MAINT)	4 WHL	S74695	2330010909537	C4D	X			X	X		
STRLR (LB-CNTNR)	26T-20FT	S69962	2330010909539	DRA	X			X	X		
STRLR (LOW BED)	25T-4WHL	S70526	2330010909540	CXF	X			X	X		
STRLR DUMP (12-15T)	4 WHL	S69843	2330010909583	CWE	X			X	X		
STRLR FB (RAMP LOAD)	60T	S69842	2330010911072	CXA	X			X	X		
STRLR VAN (CALBR LAB)	12T-4WHL	S74500	2330010911688	CWT	X			X	X		
STRLR VAN (LEARN CTR)	NONE	S74728	2330010911689	CWW	X			X	X		
STRLR VAN	SHOP 6T	S74975	2330010911690	CHP	X			X	X		
STRLR VAN (EXHIBIT)	4 WHL	S74413	2330010911691	C4A	X			X	X		
STRLR VAN (TV)	2 WHL	S75185	2330010911692	C8Z	X			X	X		
STRLR TANK (WATER)	500 GAL	S73304	2330010911694	C4S	X			X	X		
STRLR (LB-AMMO)	8-10T	S69959	2330010911695	CQC	X			X	X		
STRLR (LOW BED)	12T-2WHL	S70096	2330010911696	CWG	X			X	X		
STRLR (LOW BED)	35T-4WHL	S70602	2330010911697	CXJ	X			X	X		
STRLR (LOW BED)	5-9T	S70006	2330010911698	CRB	X			X	X		
STRLR (LOW BED)	50T-8WHL	S70759	2330010911699	CXX	X			X	X		
STRLR (FLATBED-30T)	SHOP 12T	W97470	2330010911711	CXQ	X			X	X		
STRLR (FLAT BED-TILT)	22T	S69909	2330010911731	CWD	X			X	X		
STRLR (STRADDLE)	20T	S72183	2330010911735	DVT	X			X	X		
STRLR TANK (CHEM)	5000 GAL	S73051	2330010919064		X			X	X		
STRLR (LB-FORESTRY)	15T	S69964	2330010919065	CWF	X			X	X		
STRLR (LOW BED)	60T-8WHL	S70825	2330010941373	CXP	X			X	X		
STRLR (LB-60T)	NONE	S70722	2330010977080	CXL	X			X	X		
STRLR VAN MONITOR LAB	NONE	S74938	2330011023534	C4E	X			X	X		
STRLR VAN	11-HORSE	S74550	2330011104248	C4B	X			X	X		
STRLR VAN/MOHV SYSTEM	NONE		2330012277491		X			X	X		

**VW TRUCKS, VAN**

TRK VAN	NONE	NO-LIN	2320007020070	***	X			X	X		
TRK VAN EXP W/HLG	NONE	X62091	2320009650255	FNJ	X			X	X		
TRK VAN	NONE		2320009650265		X			X	X		
TRK VAN (CARGO-4X2)	16000GVW	X61792	2320010907771	FLS	X			X	X		

**Figure E-4. Identification of required forms for nontactical wheeled vehicles and special purpose—Continued**

ECC NOUN	MODEL	LIN	NSN	EIC	REG # REQ	2408-4 WPNS REC	2408-5 MWO	2408-9 A/T/L/G	2408-9 USAGE	DD2026 USAGE	2408-9 OVHL
TRK VAN (CARGO-4X2)	19000GVW	X61792	2320010907772	FLT	X			X	X		
TRK VAN (CARGO-4X2)	5-1/2TON	X61800	2320010907773	FNF	X			X	X		
TRK VAN (CARGO-4X2)	6-1/2TON	X61800	2320010907774	FNG	X			X	X		
TRK VAN (CARGO-4X4)	3-1/2TON	X62751	2320010907775	FLV	X			X	X		
TRK VAN (CARGO-4X4)	4-1/2TON	X62751	2320010907776	FLW	X			X	X		
TRK VAN	SHOP 4X2	X62487	2320010907777	FVF	X			X	X		
TRK VAN (MEDICAL)	NONE	X62272	2320010907778	FVG	X			X	X		
TRK VAN (AUDIO TEST)	NONE	T62390	2320010908524	FWD	X			X	X		
TRK VAN (MSL TEST)	NONE	X62278	2320010909525	FWE	X			X	X		
TRK VAN (CARGO-6X4)	10 TON	X61810	2320010911043	FNH	X			X	X		
TRK VAN (CARGO-4X2)	LD TRAN	X61782	2320010911661	FWS	X			X	X		
TRK VAN (OFFICE-4X2)	4-1/2T	X62614	2320010911662	FLU	X			X	X		
TRK VAN (AIR SAMPLE)	NONE	T62322	2320010911663	FWT	X			X	X		
TRK VAN (RECRUITING)	1300GVW	X62325	2320010911664	FWU	X			X	X		
TRK VAN (ADPE MAINT)	6500GVW	X61745	2320010911665	FWV	X			X	X		
TRK VAN HEALTH CLINIC	NONE	X62273	2320010911666	FWW	X			X	X		
TRK VAN (LASER TEST)	NONE	X62254	2320010911667	FWX	X			X	X		
TRK VAN (MOB TV PROD)	NONE	X62291	2320010913203	FXP	X			X	X		
TRK VAN (TV MAINT)4X2	2-1/2T	X62281	2320010919059	FKJ	X			X	X		
TRK VAN (TV RECORD)	NONE	X62291	2320010919060	FXQ	X			X	X		
TRK VAN EXP W/HLG	60000GVW	T93240	2320010932843	FXU	X			X	X		
TRK VAN (SPEC REACT)	4X2	T62555	2320010957479	FXW	X			X	X		
TRK VAN (HEALTH UNIT)	4X2	X62276	2320010970246	FXV	X			X	X		
TRK VAN (INSTRUMENT)	43000GVW	T62159	2320011162959	FX3	X			X	X		
TRK VAN (MOB LAB)	NONE	T62458	2320011755541	FYF	X			X	X		
TRK VAN (MOB COMM)	NONE	T93688	2320011794280	FYG	X			X	X		
TRK VAN (HAZ MAT)	NONE	T93308	2320012926536		X			X	X		
TRK VAN (MOB LAB)	CHEMICAL	T62346	6640013712483	***	X			X	X		

**VX TRUCKS, REFRIGERATION**

TRK REFRIG (4-1/2T)	19000GVW	X55764	2320010907924	FLH	X			X	X		
TRK REFRIG (5-1/2T)	21000GVW	X55798	2320010907925	FM4	X			X	X		

**Figure E-4. Identification of required forms for nontactical wheeled vehicles and special purpose—Continued**

ECC NOUN	MODEL	LIN	NSN	EIC	REG # REQ	2408-4 WPNS REC	2408-5 MWO	2408-9 A/T/L/G	2408-9 USAGE	DD2026 USAGE	2408-9 OVHL
TRK REFRIG (6-1/2T)	24000GVW	X55798	2320010907926	FM5	X			X	X		
TRK REFRIG (2 1/2T)	16000GVW	X55764	2320010977083	FLJ	X			X	X		
<b>VY TRUCKS, WRECKER</b>											
TRK WRK (4X2)	16000GVW	X63847	2320010907794	FQB	X			X	X		
TRK WRK (4X2)	21000GVW	X63966	2320010907795	FQC	X			X	X		
TRK WRK (4X2)	24000GVW	X63966	2320010907796	FQD	X			X	X		
TRK WRK (6X4)	34500GVW	X63573	2320010907797	FQA	X			X	X		
TRK WRK (6X4)	36000GVW	X63984	2320010907798	FQE	X			X	X		
TRK WRK (6X4)	44500GVW	X63984	2320010907799	FQF	X			X	X		
TRK WRK (6X6)	24000GVW	X63989	2320010909529	FQH	X			X	X		
TRK WRK (4X2)	3-TON	X63167	2320010919074	FLX	X			X	X		
TRK WRECKER (4X4)	16000GVW		2320011620641	FQG	X			X	X		

**Figure E-4. Identification of required forms for nontactical wheeled vehicles and special purpose—Continued**

## **Glossary**

### **Section I Abbreviations**

#### **ACR**

ammunition condition report

#### **ADP**

automatic data processing

#### **AEPS**

Army Electronic Product Support

#### **AISM**

automated information system manual

#### **AIT**

automatic identification technology

#### **AMC**

Army Materiel Command

#### **AMCOM**

U.S. Army Aviation and Missile Command

#### **AMDF**

Army master data file

#### **AMSS**

Army materiel status system

#### **AOAP**

Army Oil Analysis Program

#### **APS**

afloat prepositioning stock

#### **AR**

Army regulation

#### **ARDEC**

Armament Research Development and Engineering Center

#### **ASIOE**

associated support items of equipment

#### **ATC**

air traffic control

#### **AWCF**

Army working capital fund

#### **BDAR**

battlefield damage assessment and repair

#### **CASCOM**

U.S. Army Combined Arms Support Command

#### **CECOM**

U.S. Army Communications-Electronics Command

**CONUS**

continental United States

**COSCOM**

Corps Support Command

**CTA**

common table of allowances

**CWO**

customer work order

**DA**

Department of the Army

**DCA**

Defense Communications Agency

**DCR**

document control register

**DCS, G-1**

Deputy Chief of Staff, G-1

**DCS, G-2**

Deputy Chief of Staff, G-2

**DCS, G-3**

Deputy Chief of Staff, G-3

**DCS, G-4**

Deputy Chief of Staff, G-4

**DIF**

deficiency investigation file

**DLA**

Defense Logistics Agency

**DOD**

Department of Defense

**DODAAC**

Department of Defense activity address code

**DODD**

Department of Defense directive

**DODI**

Department of Defense instruction

**DOT**

Department of Transportation

**DRMO**

Defense Reutilization and Marketing Office

**DS**

direct support



**DSN**  
Defense Switched Network

**DSU**  
direct support unit

**ECC**  
equipment category code

**ECOD**  
estimated cost of repairs

**EDF**  
equipment data file

**EFC**  
equivalent full charge

**EIR**  
equipment improvement recommendation

**ERC**  
equipment readiness code

**ETM**  
electronic technical manual

**FAA**  
Federal Aviation Agency

**FED LOG**  
Federal Logistics Record

**FPG**  
Field Procedures Guide

**FRA**  
Forward Repair Activity

**FSC**  
Federal Supply Catalog

**FSCM**  
Federal Stock/Supply Classification/Code for Manufacturers

**GCSSA**  
Global Combat Support System—Army

**GOCO**  
Government owned, contractor operated

**GOGO**  
Government owned, Government operated

**GS**  
general support

**GSA**  
General Services Administration

**HQ**

Headquarters

**HQDA**

Headquarters, Department of the Army

**IETM**

interactive electronic technical manual

**LAO**

logistics assistance office

**LAR**

logistics assistance representative

**LCSS**

life cycle software support

**LIDB**

logistics integrated database

**LIN**

line item number

**LO**

lubrication order

**LOGSA**

USAMC Logistics Support Activity

**LSE**

logistics support element

**MATCAT**

Materiel Catalog

**MATES**

mobilization and training equipment sites

**MCSR**

Materiel Condition Status Report

**MIF**

malfunction investigation file

**MMDF**

maintenance master data file

**MMIS**

Modification Management Information System

**MRC**

maintenance repair code

**MSC**

major subordinate command

**MTOE**

modification table of organization and equipment

**MWO**

modification work order

**NBC**

nuclear, biological, chemical

**NCOIC**

noncommissioned officer in charge

**NICP**

national inventory control point

**NIIN**

national item identification number

**NMC**

not mission capable

**NMCM**

not mission capable maintenance

**NMCS**

not mission capable supply

**NMM**

national maintenance manager

**NMP**

National Maintenance Point

**NRTS**

not reparable this station

**NSN**

national stock number

**OCOC**

on condition oil change

**OCONUS**

outside the continental United States

**OF**

optional form

**OIC**

officer in charge

**ORD**

operational requirements document

**ORF**

operational readiness float

**ORG WON**

organization work order number

**PAM**

pamphlet

**PD**

priority designator

**PDQR**

product quality deficiency report

**PLL**

prescribed load list

**PM**

program manager

**PMCS**

preventive maintenance checks and services

**POC**

point of contact

**PQDR**

Product Quality Deficiency Report

**PSI**

pounds per square inch

**QDR**

quality deficiency report

**RC**

recoverability code

**RCS**

report control symbol

**RSC**

regional support center

**SAMS**

Standard Army Maintenance System

**SDC**

sample data collection

**SF**

standard form

**SFDLR**

stock funded depot level reparable

**SMART**

Supply Maintenance Assessment and Review Team

**SOP**

standing operating procedure

**SRA**

specialized repair activity

**SSA**

Supply Support Activity

**SSN**

Social Security number

**STAMIS**

Standard Army Management Information System

**SURVIAC**

Survivability/Vulnerability Information Analysis Center

**TA**

theater Army

**TACOM**

Tank-automotive and Armaments Command

**TAMMS**

The Army Maintenance Management System

**TAMMSA**

TAMMS—Aviation

**TB**

technical bulletin

**TDA**

table of distribution and allowances

**TEDB**

TAMMS equipment database

**TIPS**

tool improvement program suggestions

**TM**

technical manual

**TMDE**

test, measurement, and diagnostic equipment

**TOE**

table of organization and equipment

**TRADOC**

Training and Doctrine Command

**UIC**

unit identification code

**ULLS**

Unit Level Logistics System

**UND**

urgency need designation

**UNK**

unknown

**USAMC**

U.S. Army Materiel Command

**USARC**

Commander, U.S. Army Reserve Command

**WARCO**

warranty coordinator

**WARS**

Worldwide Ammunition Reporting System

**WCA**

warranty claim action

**WIRS**

Watercraft Information Reporting System

**WON**

work order number

**WTB**

warranty technical bulletin

**Section II****Terms****administrative deadline**

Procedure for taking equipment out of service if the commander or unit maintenance officer determines it is necessary. Administratively dead-lined equipment is FMC per the applicable PMCS tables and is reported FMC per AR 700–138 and this pamphlet but is not used or dispatched. The following conditions are examples of typical situations (not an all-inclusive list) when administrative deadline of equipment would apply:

- a. Operation would result in a violation of published Federal, Department of the Army, local commander, or host-nation safety regulations if the equipment were dispatched or used.
- b. Pending completion of an official investigation.
- c. Pending transfer, turn-in, or disposition instructions.
- d. Pending inspection for a safety deficiency detailed under a safety-of-use message.
- e. Pending receipt of oil resample or special sample results.
- f. Pending completion of scheduled service that exceeds the ten percent variance.

**after operation checks**

PMCS checks and services performed per the TM/electronic technical manuals (ETMs) 10 series PMCS tables at the conclusion of the mission to identify and correct faults that preclude the next mission and to maintain the equipment to TM 10 and 20 series PMCS maintenance standard. Faults that render the equipment NMC and are within the authorized level of repair of the operator/crew to correct must be corrected immediately. Faults above the operator/crew authorized level of repair are immediately reported to unit maintenance for correction prior to start of the next mission. Unit maintenance performs unscheduled correction required by reports from operator/crew and performs required services per TM/ETM 20 series to maintain the equipment to the TM 10 and 20 series PMCS maintenance standard.

**ammunition**

All Army-adopted class V items.

**ammunition peculiar equipment**

Equipment used in depot to perform maintenance, surveillance, demilitarization, or preservation/packaging work on ammunition.

**Army Oil Analysis Program (AOAP)**

Part of a DOD-wide effort to detect impending equipment component failures and determine lubricant condition through evaluation of used oil samples.

**Army Oil Analysis Program evaluation criteria**

Factors, including quantitative metal wear expressions, against which the results of oil analysis are compared to determine the condition of a component or lubricant and the necessity for maintenance.

**assembly**

A combination of components/modules and parts used as a portion of, and intended for, further installation in an equipment end item (for example, engine, transmission, rotor head, electronic chassis/rack/cabinet).

**associated support items of equipment (ASIOE)**

An end item required to support the operation, maintenance, and/or transportation of a basic issue of plan item. ASIOE is listed on the BOIP of the item it supports. ASIOE has its own LIN and is separately documented into TOE/Vertical—The Army Authorization and Documents System.

**automatic test equipment**

Equipment designed to automatically evaluate the degree of unit under test performance degradation. It may be used to perform fault isolation of unit under test malfunctions.

**available days**

The days equipment is on hand in an organization and fully able to do its mission; the time that equipment is FMC.

**battlefield damage assessment and repair (BDAR)**

A wartime procedure to rapidly return disabled equipment to operational condition by expeditiously repairing, bypassing, or jury-rigging components to restore the minimum essential systems required for the support of a specific combat mission or to enable the equipment to self-recover.

**before operation checks**

Checks performed by the operator/crew per TM/ETM 10 series PMCS tables to identify faults that prevent performance of the mission and must be corrected prior to start of the mission. All faults are corrected or, if above operator/crew authorized level of repair, are reported to unit maintenance before the mission. Before operation checks should not take over 20 minutes for completion by the operator/crew.

**black box**

An electronic assembly removed and replaced from the next higher assembly at the user level and generally synonymous with line replaceable unit.

**component/module**

A combination of parts mounted together during manufacturing that may be tested, replaced as a unit, or repaired (for example, starter, generator fuel pump, and printed circuit board). The term module is normally associated with electronic equipment.

**deferred maintenance**

Authorized delay of maintenance/repair of uncorrected faults.

**deficiency**

A fault or problem that causes equipment to malfunction. Faults that make the equipment NMC are deficiencies.

**Department of Defense activity address code (DODAAC)**

A six-digit code that gives a DOD delivery address for supplies and equipment.

**depot-level reparable**

A class IX item with a maintenance repair code of D or L.

**during operations checks**

Checks performed by the operator/crew per the TM/ETM 10 series PMCS tables that monitor operation of equipment and identify faults in equipment performance during the mission. Faults that render the equipment NMC require immediate correction or authorization for limited operation using CIRCLED X status condition. All other faults are corrected (if above operator/crew authorized level of repair to correct) or reported during or after the mission.

**electromagnetic environmental effect**

Any failure (or serious effect) apparently caused by, or related to, radio waves, electromagnetism, voltage or current pulses (static discharge, lightning, electromagnetic pulse, or transient electricity), from whatever source.

**end item code**

Data element that identifies a part to a specific end item. It is a three-position alphanumeric code that uses the full

English alphabet and the numbers 2 through 9 and is structured so that each position of the code has a specific meaning.

**equipment category code (ECC)**

A two-position alphabetical code. The first letter identifies the primary category of equipment. The two-position ECC is used in ADP systems to produce the complete description of an item of equipment by make, model, noun nomenclature, line number, and national stock number if desired or required. It is also entered in specified blocks or positions on manually produced data source documents.

**equipment end item**

A final combination of assemblies, components, modules, and parts that is designed to perform an operational function and is ready for intended use. These end items are normally type-classified and assigned line item identification numbers (FED LOG) but may require other end items to perform a mission (for example, tank, truck, radio, generators, and machine guns).

**equipment improvement recommendation (EIR)**

Written reports on an SF Form 368 to report equipment faults in design operations and manufacturing of new equipment received that is below standard quality in workmanship under AR 702-7 and AR 702-7-1.

**equipment performance data**

Historical information relating to the maintainability, reliability, and supportability characteristics of systems, subsystems, and components of weapons and equipment end items accumulated during their operational application or tests simulating actual operations.

**equipment readiness codes**

A one-digit code explaining an item's importance to a unit's combat, combat support, or service support mission. The codes are assigned to items on modification tables of organization and equipment.

**failure**

The event, or inoperative state, in which any item or part of an item does not, or would not, perform as previously specified.

**fault**

A term used to indicate that a piece of equipment has a deficiency or shortcoming.

**fault isolation**

Test performed to isolate faults within a piece of equipment.

**forward support maintenance**

Maintenance oriented toward quick turnaround to the user in order to maximize combat time by minimizing repair and evacuation time.

**fully mission capable**

Systems and equipment that are safe and have all mission-essential subsystems installed and operating as designated by applicable Army regulation. An FMC vehicle or system has no faults that are listed in the not fully mission capable ready if columns of the TM/ETM 10 and 20 series PMCS tables that apply to the vehicle/system or its sub-system required by AR 700-138. The terms ready/available and fully mission capable refer to the same status: equipment is on hand and able to perform its combat missions.

**go/no-go (system)**

Condition or state of operability of a system that can have only two parameters:

- a. Go: Functioning properly.
- b. No-go: Not functioning properly. Such conditions are displayed using meters and/or visual or audible alarms, sensors, or similar mechanisms.

**line item number (LIN)**

A six-position alphanumeric number that identifies the generic nomenclature of specific types of equipment. Standard LINs consist of one alpha character followed by five numeric characters. Standard are assigned by the Army Materiel Command and are listed in the FED LOG.



**line replaceable unit**

A combination of components/modules installed in an item of equipment or system that is replaceable in the operational environment (that is, under field or combat conditions). A line replaceable unit may be a printed circuit board, black box, component, major component, alternator, carburetor, avionics, tank engine, road wheel assembly installed weapons, and so forth. This repair by replacement is normally accomplished as far forward as possible by unit (organizational) maintenance personnel.

**maintainability**

Characteristics of design that inherently provide for the retention of and/or restoration of a specified condition within a given period of time when maintenance is performed by prescribed procedures and resources.

**maintenance**

All actions necessary for retaining an item in or restoring it to a specified condition.

**maintenance, corrective**

All actions performed as a result of failure to restore an item to a specified condition. Corrective maintenance can include any or all of the following steps: localization, isolation, disassembly, interchange, reassembly, alignment, and check-out.

**maintenance capability**

Availability of those resources—facilities, tools, TMDE, drawings, technical publications, trained maintenance personnel, engineering and management support, and repair parts—required to perform maintenance operations.

**maintenance capacity**

A quantitative measure of maintenance capability usually expressed as the number of man-hours or direct labor that can be applied within a specific maintenance activity or shop during a 40-hour week (one shift, 5 days).

**maintenance concept**

The maintenance concept briefly defines the intended maintenance workload distribution within the Army maintenance system and the force structure required to maintain the end item or weapon system. It is largely based on the Organization and Operation Plan and is an integral portion of the logistics section of the requirement document.

**maintenance operations**

The management and physical performance of those actions and tasks involved in servicing, repairing, testing, overhauling, modifying, calibrating, modernizing, and inspecting materiel in the operational inventory and the provision of technical assistance to equipment users in support units of the Army Logistics System.

**maintenance significant item/materiel**

An end item, assemblage, component, or system intended for issue to the Army in the field that requires corrective maintenance services on a recurring basis.

**maintenance standard**

A measure that specifies the minimum condition to which materiel must be restored by repair, overhaul, or some other maintenance function to ensure its satisfactory performance for a specified period of service.

**maintenance support team**

A team formed from the resources of a maintenance activity, organization, or unit and specifically tailored to provide maintenance support to a designated unit or operation for specified tasks.

**maintenance technician**

Full-time technician normally having dual status as a member of a U.S. Army Reserve unit; military technician assigned to a U.S. Army Reserve TDA maintenance activity.

**major assembly**

Separately identified by type, model, and series and assigned item ID number (FED LOG). For example, receivers or receiver transmitters in radio sets and machine guns or other weapons in secondary armaments subsystems of combat vehicles.

**materiel change**

Configuration change involving substantial engineering and testing efforts on major end items to increase system/ combat effectiveness or extend the useful military life.

**materiel developer**

The principal Army MATDEVs are the Army program executive officer/program managers. For nonprogram executive officer/program managers managed systems, other materiel developers include the U.S. Army Materiel Command, U.S. Army Information Systems Command, U.S. Army Intelligence and Security Command, Chief of Engineers, The Surgeon General, and Strategic Defense Command.

**materiel maintenance**

The function of sustaining materiel in an operational status, restoring it to a serviceable condition, or updating and upgrading its functional usefulness through modification or other alteration.

**mission-essential materiel**

That materiel authorized and assigned to approved combat and combat support forces that should be immediately employed to: destroy the enemy or its capacity to continue war; provide battlefield protection of personnel; communicate under war conditions; detect, locate, or maintain surveillance over the enemy; and permit contiguous combat transportation and support of forces and materiel. Equipment assigned to training missions of the same type and configuration as that assigned to combat and combat support forces and designated to be immediately employed for the purposes enumerated above is also mission-essential materiel.

**mobilization and training equipment site (MATES)**

An Army National Guard TDA maintenance facility which, when collocated with a combined support maintenance shop, provides full-time unit support to Army National Guard equipment assigned to the site. When not collocated, MATEs provide unit, DS, and GS support to equipment and units assigned.

**module**

An assembly containing a complete self-contained circuit or subcircuit. It may consist of a single printed circuit board, in which case it is synonymous with a printed circuit board or may be comprised of two or more printed circuit boards mechanically attached to one another and removable from the next high assembly as a single unit.

**nonavailable days**

The number of days the equipment was not able to do its mission; the time the equipment is NMC. This term is used on DA Form 2406 to rate equipment's ability to do its combat or combat support job.

**not mission capable (NMC)**

A materiel condition indicating that equipment cannot perform any one of its combat missions. NMC is divided into not mission capable maintenance (NMCM) or not mission capable supply (NMCS).

**not mission capable maintenance**

Equipment that cannot perform its combat mission because of maintenance work underway or needed.

**not mission capable supply**

Equipment that cannot perform its combat mission because of maintenance work stoppage due to supply backorders.

**off-site maintenance**

Maintenance authorized to be performed by designated maintenance facilities not located where the equipment is operated.

**oil analysis**

A test or series of tests (spectrometric and physical property) that provide an indication of equipment component and oil condition by applying methods of quantitative measurement of wear metals and detection of contaminants in an oil sample.

**on-condition oil change**

An oil change directed by the AOAP laboratory as a result of findings relative to the condition of the oil and its lubricating capability.

**on-site maintenance**

Maintenance authorized to be performed where the equipment is operated.

**operational readiness float**

A quantity of selected end items or major components of equipment authorized for stockage at CONUS installations and overseas support maintenance activities to extend their capability to respond to the materiel readiness requirements of supported activities. This is accomplished by providing supported activities with serviceable replacements from ORF assets when like items of equipment of supported activities cannot be repaired or modified in time to meet operational requirements.

**pacing items**

Major weapons or equipment systems of such importance that they are subject to continuous monitoring and management at all levels of command. Pacing items are identified in AR 220-1. Pacing items are noted on DA Form 5990-E or DA Form 2407.

**part**

An item that cannot normally be disassembled or repaired, or is of such a design that disassembly or repair is impractical (for example, bracket, gear, resistor, or toggle switch).

**physical property tests**

Analytical tests of used oil samples to detect oil property changes resulting from changing equipment conditions or maintenance practices.

**possible days**

The number of calendar days an item was on hand on the property book during the DA Form 2406 report. For an item received during the reporting period, count the first day it was on hand as a whole possible day. Do not count the last day an item is on hand (the day lost from the property book) as a possible day.

**precombat checks**

Essential functional and safety checks performed by the operator/crew per the system's precombat checklist to ensure the system can perform its war-fighting mission. Faults that prevent the performance of the mission must be corrected prior to the start of the mission. All other faults are corrected or, if above operator/crew authorization to correct, reported during or after the mission.

**preventive maintenance**

All actions performed in an attempt to retain an item in a specified condition by providing systematic inspection, detection, and prevention of incipient failures.

**preventive maintenance checks and service (PMCS)**

Preventive maintenance checks and service is the care, servicing, inspection, detection, and correction of minor faults before these faults cause serious damage, failure, or injury. The procedures and the category of maintenance to perform PMCS are found in the 10 and 20 series equipment TMs and LOs or ETMs.

**quality deficiency report**

The authorized means for users of Army equipment to report, either by message or SF Form 368, equipment faults in design, operations, and manufacture.

**readiness**

The capability of a unit/formation, ship, weapon system, or equipment to perform the mission or functions for which it is organized or designed

**repair**

Restoration or replacement of parts and/or units to maintain efficient operating conditions.

**repairable item**

An item that can be restored to perform all of its required functions by corrective maintenance.

**reparable**

Class IX secondary items that carry an MRC of D, F, H, or L.

**restriction**

An order placing special working limits on materiel. The limits are set for safety or because of degraded performance.

**scheduled PMCS services**

Checks and services performed by unit maintenance personnel with assistance from the operation/crew per the TM/ETM 10 and 20 series PMCS tables and lube orders. Some equipment also requires scheduled PMCS tasks to be performed by DS personnel per the equipment TM/ETM 30 series. All equipment faults are corrected or, if above the unit maintenance level authorization (per the maintenance allocation chart) to correct, job ordered to DS maintenance. Deferred maintenance is completed during the scheduled service. Upon conclusion of the service, equipment should meet the TM/ETM 10 and 20 series maintenance standards.

**serious defect (applies to ammunition)**

Defect resulting from bad design, manufacturing, handling, or storage that may cause malfunctions when ammunition is handled or fired.

**service life surveillance**

Postproduction inspection, test, and analysis activity that verifies the actual condition of items after periods of use or storage.

**shop replacement unit**

A component/module installed in an end item of equipment, system, or LRU that is replaceable only in a repair facility (shop environment) designated in the applicable maintenance allocation chart.

**shortcoming**

A fault that requires maintenance or supply action on a piece of equipment but does not render equipment NMC.

**spectrometric analysis**

A method to determine the concentration of various chemical elements in an oil sample by means of spectroscopy, primarily to detect the presence of abnormal amounts of wear metal that may indicate the potential failure of a component.

**substitute item**

An item authorized issue instead of, or in place of, an authorized standard item of like nature and quality. The FED LOG identifies items and procedures for making substitutions.

**subsystem**

A separately authorized item issued or intended to work with other items to form an operational unit/system.

**support equipment**

All ancillary and associated equipment (mobile or fixed) required to separate and support a materiel system. This includes ASIOE such as trucks, air conditioners, generators, ground handling and maintenance equipment, tools metrology, calibration and communications equipment, test equipment, and automatic test equipment with diagnostic software for both on and off equipment maintenance.

**support system**

Collectively, those tangible logistic support resources required to maintain a materiel system in an operationally ready condition. It is developed with the materiel system and merged with the ongoing logistic systems upon production and development. The following elements of integrated logistics support constitute the support system: support and test equipment, supply support, transportation and handling, technical data, facilities, and trained personnel. The other elements of integrated logistics support are the means by which the support system is developed and implemented.

**surge**

The act of expanding an existing depot maintenance repair capability to meet increased requirements by adjusting shifts; adding skilled personnel, equipment, spares, and repair parts to increase the flow of repaired or manufactured materiel to the using activity; or for serviceable storage.

**suspended munitions**

Munitions removed from issue, movement, test, and use with or without limitations. These are removed because of a suspected or known unsafe or defective condition.

**system**

A combination of equipment end items, assemblies, major components, components, modules, and parts assembled as a single functional unit to perform a task or mission.

**test, measurement, and diagnostic equipment (TMDE)**

Any system or device capable of being used to evaluate the operating condition of a system or equipment to identify and/or isolate any actual or potential malfunction. TMDE also includes automatic test equipment and test program sets.

**unit identification code**

A six-character code assigned to a specific unit. All units, organizations, and activities use their own UIC. Contractors, manufacturers, and commercial activities do not have UICs. They use the five-digit Commercial and Government Entity code prescribed by SB 708-43. Put the letter K in front of the Federal Stock/Supply Classification/Code for Manufacturers (FSCM). For example, General Motors FSCM 24617 is turned into a contractor UIC, K24617.

**unit maintenance shop**

Facility located in conjunction with a U.S. Army Reserve center; unit training and equipment site; a maintenance facility located in conjunction with a U.S. Army Reserve center.

**unsafe condition**

An occurrence of hazard severity category I or II or MIL-STD-882. This includes the conditions that cause loss or serious damage to the end item or major components, loss of control, death, serious injury, or illness.

**user representative**

The combat developer designated to represent the user in development and testing of new or improved systems.

**Section III****Special Abbreviations and Terms**

This section contains no entries.

**UNCLASSIFIED**

**PIN 081693-000**